



The Atlantis Book 2024





CONTENTS

INTRODUCTION	4	Our Difference
	5	No leaks. Guaranteed.
	6	Atlantis Design Centres
	9	Create your dream shower
	11	The Atlantis Range
	12	Freeform Custom Showers
PRODUCT RANGES		Showers
	14	Linea Quattro™
	22	EasyTile™
	28	Ebony & Ivory™
	34	Verve™ <i>NEW</i>
	40	Black Pearl™
	46	Quub™
	52	Naked Frameless™ Screens
		Finishes & Accessories
	60	Ellure™ 'Tile Look' Walls
	64	Architectural Finishes
	66	Foundry Series Hardware
	68	EasyNiche™
	73	EasyNiche™ Recessed Towel Warmer
	74	Icona™ Heated Towel Rails
RESOURCES	84	Warranty
	86	Technical
	92	Order Forms
ABOUT US	107	Our Story

OUR DIFFERENCE

Atlantis proudly design and manufacture each and every one of our products.

Holding numerous patents and with a vision to be at the cutting edge of bathroom design in New Zealand and around the world, we aren't satisfied with the status-quo. Our team includes talented designers, clever makers, and creative thinkers who are dedicated to pushing the boundaries of innovation and craftsmanship to create exceptional bathroom solutions.

We are equally passionate about delivering outstanding customer service, and providing unparalleled support at each step of your journey with Atlantis.



**NZ DESIGNED
& ASSEMBLED**

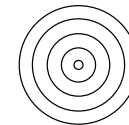

**PRECISION
ENGINEERED**

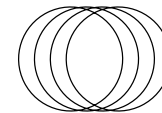

**TRUSTED FOR
OVER 20 YEARS**

NO LEAKS. **GUARANTEED.**

With Atlantis you can be sure that leaks from your tiled shower are a thing of the past.

Whatever your bathroom environment and flooring structure, our primary focus is to create a superior shower solution that will make your shower space watertight.

At Atlantis we are so confident in the superior performance of our Linea Quattro™ & EasyTile™ Shower Base Systems that we guarantee their durability and leak-free function for a minimum of 25 years* – exceeding the requirements of the New Zealand Building Code, and giving you peace of mind that your choice in Atlantis is the right one.

* See detailed Warranty Statement on Pg. 84.

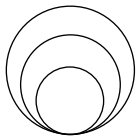

**25 YEAR WARRANTY
TILE-OVER TRAYS**

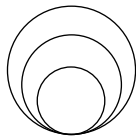

**25 YEAR WARRANTY
TILED EASYNICHES**

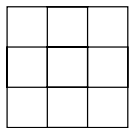

TANZ APPRAISED

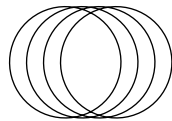

TRUSTED SINCE 2001



ATLANTIS DESIGN CENTRES

Atlantis display and sell a wide range of products through our Retail Network nationwide. In addition Atlantis have three dedicated Design Centres – Auckland, Tauranga or Christchurch – with the full Atlantis Range on display. Discuss the options with an Atlantis Representative, and take away any samples that may be relevant to your new bathroom design.

We welcome all clients, from single-bathroom renovators through to large-scale developers. We look forward to assisting you with your bathroom project.

AUCKLAND



FIND US AT:

46B Stanley Street, Parnell

Please request an appointment:
atlantis.co.nz/book-a-consultation

TAURANGA



FIND US AT:

26 Porutu Place, Tauriko

Please request an appointment:
atlantis.co.nz/book-a-consultation

CHRISTCHURCH



FIND US AT:

38B Brisbane Street, Sydenham

Please request an appointment:
atlantis.co.nz/book-a-consultation





CREATE YOUR DREAM SHOWER IN SIX SIMPLE STEPS

01.

MEASURE

Work out the measurements and ideal shape to fit your space. Often there are multiple options that could work, so keep an open mind.

02.

SELECT BASE & DRAIN

Choose from our extensive range of base designs to best suit your environment. Select from tiled or prefinished trays and a range of waste styles and positions.

03.

CHOOSE A SCREEN OPTION

Select your preferred screen option to match from our range of styles – Hinged, Sliding or Fixed Panel (Walk-in).

04.

DECIDE ON ACCESSORIES

Add the finishing touches with an Acrylic Wall Liner or Ellure™ Walls, Hardware Upgrade, EasyNiche™ and/or Icona™ Heated Rails.

05.

ORDER YOUR SHOWER

Purchase your selected products via your preferred retailer. Find your nearest store – atlantis.co.nz/find-retailer/

06.

BOOK YOUR INSTALLATION

Now it's time to choose your tapware, tiles (if required) and book your shower installation – atlantis.co.nz/find-an-installer/

EXPLORE THE ATLANTIS RANGE OVER THE PAGE TO GET STARTED



ONLINE PRODUCT SELECTOR

Simplify your experience with Atlantis. Visit our website for a simple walk-through of all Atlantis products. Search and filter ranges, make a list and then easily send it to your nearest retailer(s) to request a quote.

Visit atlantis.co.nz/products for more information.

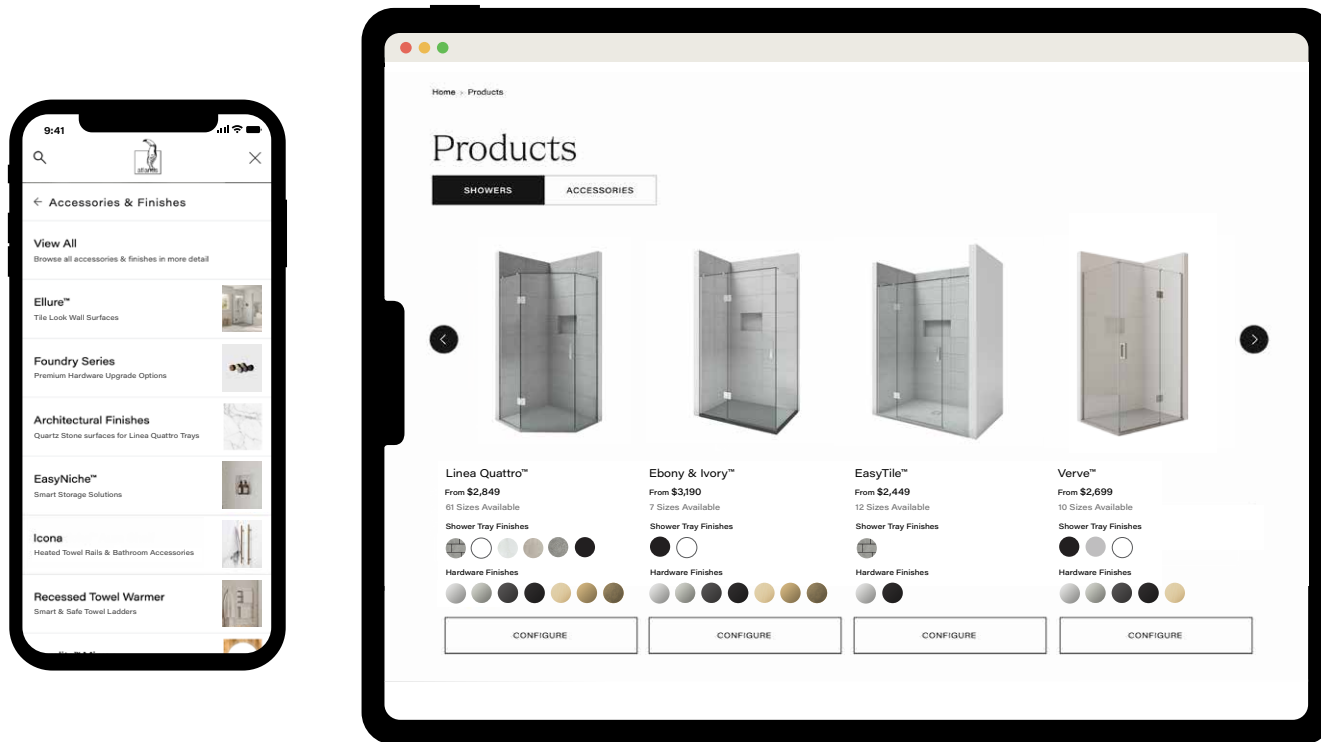



THE ATLANTIS RANGE

Explore our extensive range of market-leading tiled & prefinished showers, frameless screens and bathroom products.



SHOWERS

TILED SHOWERS		'PREFINISHED' SHOWERS				SCREENS ONLY (NO BASE)
						
Linea Quattro™ Tiled Channel Drain Shower System	EasyTile™ Tiled Centre Drain Shower System	Ebony & Ivory™ Stone Mini-Channel Drain Shower System	Verve™ <i>NEW</i> Matte Acrylic Shower System	Black Pearl™ Gloss White Acrylic Shower System	Quub™ Affordable Acrylic Shower System	Naked Frameless™ Premium Screens & Hardware Only (No Base)
 Customisable				 Customisable		

FINISHES

WALL LININGS	FLOOR FINISHES	HARDWARE FINISHES
		
Ellure™ Tile Look Walls Tile Look Acrylic Wall Panel System	Architectural Finishes Factory-fitted Stone Floor Overlays for Linea Quattro Trays	Foundry Series Premium Hardware Upgrades for Atlantis Showers

ACCESSORIES

SMART STORAGE	HEATED TOWEL RAILS
	
EasyNiche™ Smart Bathroom Storage Solutions	Icona™ Towel Rails Premium Rails, Poles & Bathroom Accessories



Still can't find what you're looking for?

We also manufacture Freeform Custom Showers to your specification. See Pg. 12 or visit atlantis.co.nz/showers/custom

FREEFORM CUSTOM SHOWERS

When you can't quite find the right size shower to suit your space, Freeform Custom Showers are here to help.

Atlantis manufacture made-to-measure shower trays and screens to suit almost any bathroom space. Rely on 85-100mm wall upstands for guaranteed watertightness, factory-fitted glazing channels and an integrated waste outlet.

View custom shower examples below. For more information, visit atlantis.co.nz/showers/custom

CUSTOMISABLE SHOWER OPTIONS AVAILABLE:

TILED SHOWERS

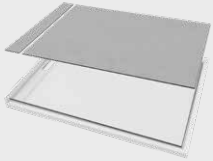

Linea Quattro™
Tiled Channel Drain Shower System
Learn more about the system on Pg. 14

2 WALL SHOWERS

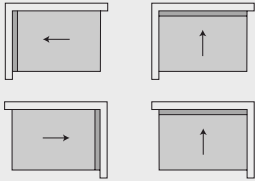

3 WALL SHOWERS

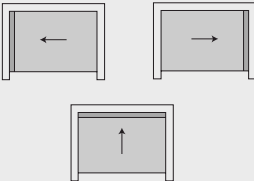

3½ WALL SHOWERS

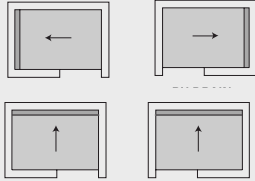

1 WALL SHOWERS



'PREFINISHED' SHOWERS



Black Pearl™
Gloss White Acrylic Shower System
Learn more about the system on Pg. 40

2 WALL SHOWERS

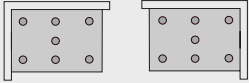

3 WALL SHOWERS

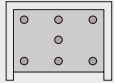

3½ WALL SHOWERS

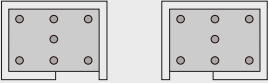

1 WALL SHOWERS



DRAW YOUR SHOWER PLAN ON THIS PAGE AND SUBMIT TO ATLANTIS – ATLANTIS.CO.NZ/SHOWERS/CUSTOM

CONFIGURATION	FLOOR FINISH	THRESHOLD TYPE	FRAMELESS SCREENS (IF AVAILABLE)
<input type="checkbox"/> # OF FRAMED WALLS	<input type="checkbox"/> TILED TRAY <input type="checkbox"/> ACRYLIC TRAY	<input type="checkbox"/> LEVEL ENTRY <input type="checkbox"/> STEP ENTRY	<input type="checkbox"/> HINGED SCREEN <input type="checkbox"/> SLIDING SCREEN <input type="checkbox"/> FIXED PANEL





Tiled Showers



LINEA QUATTRO™

Elevate your everyday



Linea Quattro London Hinged (Level Entry)
Brushed Nickel Hardware Upgrade
EasyNiche Tiled 1540x340mm

LINEA QUATTRO™

Elevate your everyday

Choose Linea Quattro™ for clean lines and a single continuous tiled floor level from the bathroom into the shower area.

The channel drain is located discretely at the side or back of the shower, and can be accessed for cleaning easily.

Featuring solid stainless steel and aluminium hardware, and including superior CristalVision 2160mm high Naked Frameless™ glass screens, Linea Quattro™ is your first choice for a luxurious showering experience.

Find Linea Quattro™ Technical Information on Pg. 86.

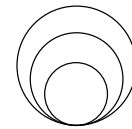

**25 YEAR
WARRANTY**

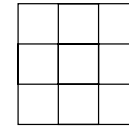

**TANZ
APPRAISED**

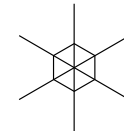

**CRISTALVISION
NANO-TREATED**

LINEA QUATTRO FLOOR FINISHES AVAILABLE:



SEE PG. 65
FOR MORE
INFO



MW



CG



ALA



SU



UC



MB

LINEA QUATTRO HARDWARE FINISHES AVAILABLE:



SEE PG. 67
FOR MORE
INFO



BN



GM



MB



BG



PB



AB

3 WALL 800 DEEP

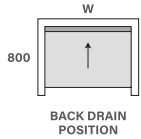

NAME SIZE (mm)	WIDTH	DEPTH	2160mm HIGH FRAMELESS		
			BACK DRAIN	HINGED DOOR HR	SLIDING DOOR SL
PRAGUE	900 x 800		•	•	
DALLAS	1000 x 800		•	•	
BEIJING	1100 x 800		•	•	•
STOCKHOLM	1200 x 800		•	•	•
LINCOLN	1300 x 800		•	•	•
MOSCOW	1400 x 800		•	•	•
WASHINGTON	1500 x 800		•	•	•
BUDAPEST	1600 x 800		•	•	•
AMSTERDAM	1700 x 800		•	•	•
COPENHAGEN	1800 x 800		•	•	•
HAVANA	1900 x 800		•	•	•
SEOUL	2000 x 800		•	•	•

3 WALL 900 DEEP

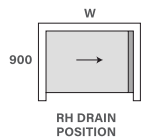
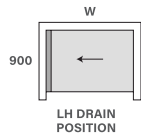
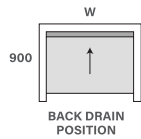

NAME SIZE (mm)	WIDTH	DEPTH	2160mm HIGH FRAMELESS			HINGED DOOR HR	SLIDING DOOR SL	WALK-IN FIXED PANEL FX
			LH DRAIN	RH DRAIN	BACK DRAIN			
ROME	900 x 900				•	•		
TURIN	1000 x 900		•	•	•	•		
ZURICH	1100 x 900				•	•		
BERLIN	1200 x 900		•	•	•	•	•	
VIENNA	1300 x 900				•	•		
SANTIAGO	1400 x 900		•	•	•	•		
BARCELONA	1500 x 900		•	•	•	•		
OTTAWA	1600 x 900		•	•	•	•		
PHOENIX	1700 x 900				•	•		
TOKYO	1800 x 900		•	•	•	•		
OSLO	1900 x 900				•	•		
SINGAPORE	2000 x 900		•	•	•	•		

FIND TECHNICAL INFORMATION ON PG. 86. FIND ORDER FORMS ON PG. 92.

3 WALL 1000 DEEP

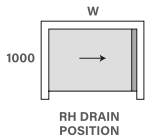
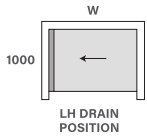
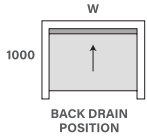

NAME
SIZE (mm)

	WIDTH	DEPTH	LH DRAIN	RH DRAIN	BACK DRAIN	2160mm HIGH FRAMELESS	HINGED DOOR HR	SLIDING DOOR SL	WALK-IN FIXED PANEL FX
MADRID	1000 x 1000		•	•	•		•		
GLASGOW	1100 x 1000				•		•	•	
TORONTO	1200 x 1000		•	•	•		•	•	•
EDINBURGH	1300 x 1000				•		•	•	•
LISBON	1400 x 1000		•	•	•		•	•	•
HELSINKI	1500 x 1000		•	•	•		•	•	•
CHICAGO	1600 x 1000		•	•	•		•	•	•
DUBAI	1700 x 1000				•		•	•	•
SEATTLE	1800 x 1000		•	•	•		•	•	•
HOUSTON	1900 x 1000				•		•	•	•
LONDON	2000 x 1000		•	•	•		•	•	•

LH DRAIN
RH DRAIN
BACK DRAIN
2160mm HIGH FRAMELESS

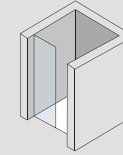
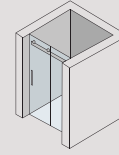
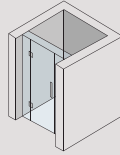

HINGED DOOR HR

SLIDING DOOR SL

WALK-IN FIXED PANEL FX

3 WALL EXTRA DEEP 900 WIDE

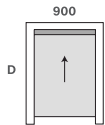

NAME
SIZE (mm)

	WIDTH	DEPTH	BACK DRAIN	2160mm HIGH FRAMELESS	HINGED DOOR HR
AUSTIN	900 x 1200		•		•
LIMA	900 x 1400		•		•
TUSCANY	900 x 1600		•		•
MEMPHIS	900 x 1800		•		•

BACK DRAIN
2160mm HIGH FRAMELESS

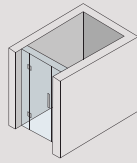

HINGED DOOR HR

3½ WALL 1000 DEEP

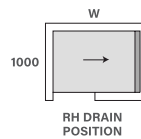
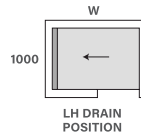

NAME
SIZE (mm)

	WIDTH	DEPTH	LH DRAIN	RH DRAIN
NAGOYA	1400 x 1000		•	•
EDMONTON	1500 x 1000		•	•
ORLANDO	1600 x 1000		•	•
HONOLULU	1800 x 1000		•	•

LH DRAIN
RH DRAIN

NO SCREEN
WALK-IN ONLY

ALL 3 WALL SCREEN TYPES ARE REVERSIBLE



FIND TECHNICAL INFORMATION ON PG. 86. FIND ORDER FORMS ON PG. 92.

2 WALL
800 DEEP
900 DEEP
1000 DEEP

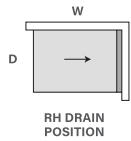
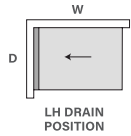

NAME SIZE (mm)	LH DRAIN RH DRAIN 2160mm HIGH FRAMELESS	2160mm HIGH FRAMELESS		
		HINGED DOOR HR	SLIDING DOOR SL	WALK-IN FIXED PANEL FX
WIDTH DEPTH				
LIVERPOOL	1200 x 800	•	•	•
OXFORD	1400 x 800	•	•	•
DUBLIN*	900 x 900	•	•	•
BOSTON	1000 x 900	•	•	•
RIO	1100 x 900	•	•	•
MILAN	1200 x 900	•	•	•
GENEVA	1300 x 900	•	•	•
PARIS	1400 x 900	•	•	•
SOFIA	1500 x 900	•	•	•
KANSAS	1600 x 900	•	•	•
TOLEDO	1800 x 900	•	•	•
MIAMI*	1000 x 1000	•	•	•
SHANGHAI	1200 x 1000	•	•	•
VANCOUVER	1400 x 1000	•	•	•
TAIPEI	1500 x 1000	•	•	•
CLEVELAND	1600 x 1000	•	•	•
RICHMOND	1800 x 1000	•	•	•

*SCREENS INDICATED ARE REVERSIBLE

2 WALL ANGLE FRONT
1000 DEEP

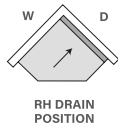
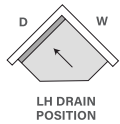

NAME SIZE (mm)	LH DRAIN RH DRAIN 2160mm HIGH FRAMELESS	HINGED DOOR HR
		WIDTH DEPTH
ATHENS	1000 x 1000	•

ANGLE FRONT SCREENS ARE REVERSIBLE

FIND TECHNICAL INFORMATION ON PG. 86. FIND ORDER FORMS ON PG. 92.



Linea Quattro Milan Sliding (Step Entry)
Brushed Nickel Hardware Upgrade
EasyNiche Tiled 640x340mm



Linea Quattro Athens Hinged (Step Entry)
Brushed Gold Hardware Upgrade
EasyNiche Tiled 490x340mm





Tiled Showers



EASYTILE™

EASYTILE™

NZ's original tileover shower system



EasyTile Symphony Hinged
Matte Black Hardware Upgrade
Icona Chateau Towel Poles (Black)

EASYTILE™

NZ's original tileover shower system

The versatile tile-over shower solution, designed specifically for NZ bathrooms.

Achieve a tiled shower safely and securely with the EasyTile™ system, NZ's original tile-over system. Backed by a 25 year durability warranty, the EasyTile™ shower system is designed to be completely tiled. Supplied with hinged screens @ 1960mm high, Rely on EasyTile™ for a 'bulletproof' proprietary tray and screen system that will last the lifetime of your bathroom.

Find EasyTile™ Technical Information on Pg. 87.

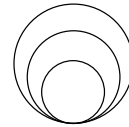

**25 YEAR
WARRANTY**



**NZ DESIGNED
& ASSEMBLED**

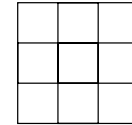

**TANZ
APPRAISED**

**EASYTILE FLOOR
FINISHES AVAILABLE:**

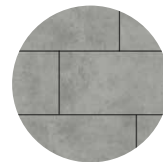

**TILE-OVER
ON SITE**

**EASYTILE HARDWARE
FINISHES AVAILABLE:**

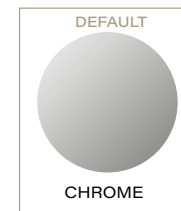

SEE PG. 67 FOR MORE INFO

3 WALL

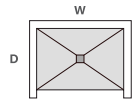

NAME
SIZE (mm)

CENTRE DRAIN
1960mm HIGH
FRAMELESS

	WIDTH	DEPTH	HINGED DOOR F	
COMMANDER	900 x 900		•	•
AQUARIUS	1000 x 1000		•	•
SYMPHONY	1200 x 900		•	•
IMMERSION	1400 x 1000		•	•

ALL 3 WALL SCREENS ARE REVERSIBLE

2 WALL

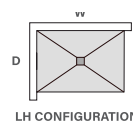

NAME
SIZE (mm)

CENTRE DRAIN
1960mm HIGH
FRAMELESS

	WIDTH	DEPTH	HINGED DOOR B	
BOUTIQUE*	900 x 900		•	•
HARMONY*	1000 x 1000		•	•
SPLASH (LH)	1200 x 900		•	•
ENCAPSULATOR (RH)	1200 x 900		•	•
FABULOUS (LH)	1400 x 1000		•	•
TRANQUILITY (RH)	1400 x 1000		•	•

*SCREENS INDICATED ARE REVERSIBLE

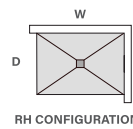

2 WALL ANGLE FRONT

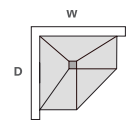

NAME
SIZE (mm)

CENTRE DRAIN
1960mm HIGH
FRAMELESS

	WIDTH	DEPTH	HINGED DOOR HA	
AMBIENCE	900 x 900		•	•
VIVIDO	1000 x 1000		•	•

ANGLE FRONT SCREENS ARE REVERSIBLE



EasyTile Vivido Hinged
EasyNiche Tiled 490x340mm

&



'Prefinished' Showers

&

EBONY & IVORY™

Designed for dramatic effect



&

🏠 Ebony & Ivory Rhythm Sliding in Ebony
Matte Black Hardware Upgrade
EasyNiche Tiled 640x340mm

EBONY & IVORY™

Designed for dramatic effect

Featuring a solid LiberettoStone™ shower tray in Ebony Black or Ivory White, Ebony & Ivory™ redefines bathroom elegance.

A mini-channel drain is located discretely at the side of the shower, and can be accessed for cleaning easily and conveniently.

Featuring solid stainless steel and aluminium hardware, and including superior 2150mm high CristalVision™ Naked Frameless™ screens, Ebony & Ivory™ is a masterclass in shower design and luxury.

Find Ebony & Ivory™ Technical Information on Pg. 88.

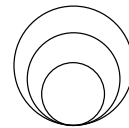

**10 YEAR
WARRANTY**

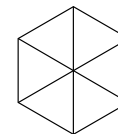

**SOLID STONE
CONSTRUCTION**

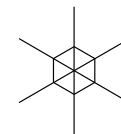

**CRISTALVISION
NANO-TREATED**

**EBONY & IVORY TRAY
FINISHES AVAILABLE:**



IVORY STONE

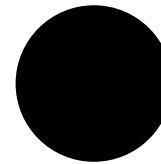

EBONY STONE

**EBONY & IVORY HARDWARE
FINISHES AVAILABLE:**



DEFAULT

CHR



BN



GM



MB

SEE PG. 67
FOR MORE
INFO



BG



PB



AB

3 WALL

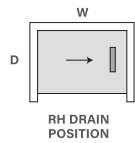
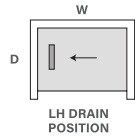

NAME	SIZE (mm)	LH DRAIN	RH DRAIN	2150mm HIGH FRAMELESS	3 WALL SCREEN TYPES		
					HINGED DOOR HR	SLIDING DOOR SL	WALK-IN FIXED PANEL FX
MANILOW	1200 x 900
HYMN	1200 x 1000
RUMBA	1400 x 1000

ALL 3 WALL SCREEN TYPES ARE REVERSIBLE 

2 WALL

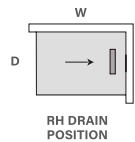
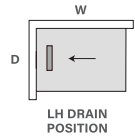

NAME	SIZE (mm)	LH DRAIN	RH DRAIN	2150mm HIGH FRAMELESS	2 WALL SCREEN TYPES		
					HINGED DOOR HR	SLIDING DOOR SL	WALK-IN FIXED PANEL FX
MELODY*	1000 x 1000
LYRIC	1200 x 900
TAMBORA	1200 x 1000
RHYTHM	1400 x 1000

*SCREENS INDICATED ARE REVERSIBLE 



🔗 Ebony & Ivory Tambora Hinged in Ivory
EasyNiche Tiled 640x340mm





'Prefinished' Showers



NEW

VERVE™

VERVE™

The luxury Acrylic Shower



🏷️ Verve 1500x1000 3 Wall Sliding in Silk
Gunmetal Hardware Upgrade
EasyNiche Tiled 640x340mm

NEW VERVE™

The luxury Acrylic Shower

The latest addition to the Atlantis range, Verve™ is the ultimate acrylic shower.

Featuring a sleek *matte* acrylic shower tray in multiple finishes, ultra-low profile base and minimal drain that appears to blend in to the surface of the tray. Along with it's stunning new tray, Verve™ is supplied with CristalVision™ screens @ 2050mm high.

Select your preferred size & tray finish, screen type & hardware finish, and enjoy a tranquil showering experience with Verve™.

Find Verve™ Technical Information on Pg. 89.

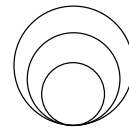

**10 YEAR
WARRANTY**



**NZ DESIGNED
& ASSEMBLED**

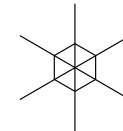

**CRISTALVISION
NANO-TREATED**

VERVE TRAY FINISHES AVAILABLE:



**SILK
(MATTE WHITE)**

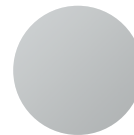

**ASH
(MATTE GREY)**

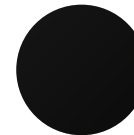

**CHARCOAL
(MATTE BLACK)**

VERVE HARDWARE FINISHES AVAILABLE:



**DEFAULT
CHR**



BN



GM

SEE PG. 67
FOR MORE
INFO



BG



MB

3 WALL

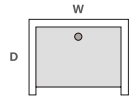

SIZE (mm)

WIDTH	DEPTH	CENTRE REAR DRAIN 2050mm HIGH FRAMELESS	HINGED DOOR HR	SLIDING DOOR SL
900 x 900		•	•	•
1000 x 1000		•	•	•
1200 x 900		•	•	•
1500 x 1000		•	•	•

CENTRE REAR DRAIN

2050mm HIGH
FRAMELESS

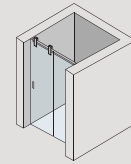
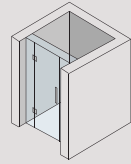

HINGED
DOOR HR

SLIDING
DOOR SL

ALL 3 WALL SCREENS ARE REVERSIBLE

2 WALL

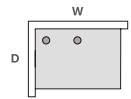

LH CONFIGURATION

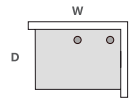

RH CONFIGURATION

SIZE (mm)

WIDTH	DEPTH	CENTRE REAR DRAIN REAR DRAIN 2050mm HIGH FRAMELESS	HINGED DOOR HR	SLIDING DOOR SL
900 x 900*		•	•	•
1000 x 1000*		•	•	•
1200 x 900		•	•	•
1500 x 1000		•	•	•

CENTRE REAR DRAIN

REAR DRAIN
2050mm HIGH
FRAMELESS

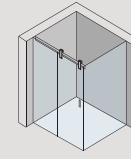
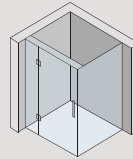

HINGED
DOOR HR

SLIDING
DOOR SL

*SCREENS INDICATED ARE REVERSIBLE

2 WALL ANGLE FRONT

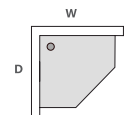

SIZE (mm)

WIDTH	DEPTH	REAR DRAIN 2050mm HIGH FRAMELESS	HINGED DOOR HA
900 x 900		•	•
1000 x 1000		•	•

REAR DRAIN

2050mm HIGH
FRAMELESS

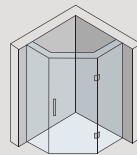

HINGED
DOOR HA

ANGLE FRONT SCREENS ARE REVERSIBLE



🏠 Verve Angle Front Hinged in Charcoal
Ellure Tile Look Walls (Simply White)
Gunmetal Hardware Upgrade
EasyNiche Retrofit 400x300mm

VERVE™





'Prefinished' Showers



BLACK PEARL™

BLACK
PEARL™

Refined style, enhanced function



Black Pearl Mauritius Hinged
Ellure Tile Look Walls (Simply White)
EasyNiche Retrofit (White)
EasyNiche Recessed Towel Warmer

BLACK PEARL™

Refined style, enhanced function

A premium, frameless, top of class acrylic shower.

Black Pearl™ is supplied with superior hardware, including an industrial machined stainless steel waste outlet. Supplied with Hinged or Soft-Close Sliding CristalVision™ frameless screens @ 2060mm high – this acrylic shower is a cut above the rest.

The Black Pearl™ shower system suits Ellure™ Tile Look Walls, acrylic flat wall liner or ceramic tiled walls.

Find Black Pearl™ Technical Information on Pg. 90.

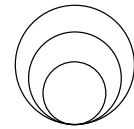

**7 YEAR
WARRANTY**



**NZ DESIGNED
& ASSEMBLED**

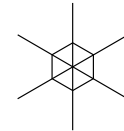

**CRISTALVISION
NANO-TREATED**

**BLACK PEARL TRAY
FINISHES AVAILABLE:**



GLOSS WHITE

**BLACK PEARL HARDWARE
FINISHES AVAILABLE:**

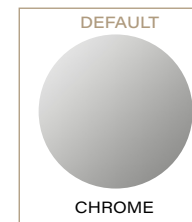

CHROME

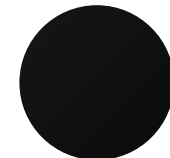

MATTE BLACK

SEE PG. 67 FOR MORE INFO

3 WALL

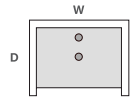

NAME	SIZE (mm)	CENTRE DRAIN		2060mm HIGH FRAMELESS	
		CENTRE REAR DRAIN	REAR DRAIN	HINGED DOOR F	MIGLIDE SLIDING DOOR MG
MANIHIKI	900 x 750	*		*	*†
ARUBA	1200 x 750	*		*	*
DELSOL	1500 x 750	*		*	*
TRISTAN	900 x 900	*	*	*	*†
SEYCHELLES	1000 x 1000	*	*	*	*
CAYMAN	1200 x 900	*	*	*	*
PENRHYN	1500 x 900	*	*	*	*
BERMUDA	1500 x 1000	*	*	*	*
CALYPSO	1800 x 1000	*	*	*	*

ALL 3 WALL SCREEN TYPES ARE REVERSIBLE

† OPTIONS INDICATED ARE STANDARD SLIDING SCREENS (NOT SOFT-CLOSE)

2 WALL

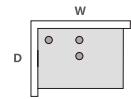

LH CONFIGURATION

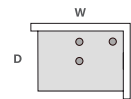

RH CONFIGURATION

NAME	SIZE (mm)	CENTRE DRAIN		2060mm HIGH FRAMELESS	
		CENTRE REAR DRAIN	REAR DRAIN	HINGED DOOR B	MIGLIDE SLIDING DOOR MG
PITCAIRN (LH)	900 x 750	*		*	*†
TROPICANA (RH)	900 x 750	*		*	*†
MONACO*	900 x 900	*	*	*	*†
TAHITIAN (LH)	1000 x 900	*		*	*
ZANZIBAR (RH)	1000 x 900	*		*	*
MALIBU*	1000 x 1000	*	*	*	*
GRENADA (LH)	1200 x 750	*		*	*
ACAPULCO (RH)	1200 x 750	*		*	*
BAHAMAS (LH)	1200 x 900	*	*	*	*
MAURITIUS (RH)	1200 x 900	*	*	*	*
TOBAGO (LH)	1500 x 750	*		*	*
BARBADOS (RH)	1500 x 750	*		*	*
ANTIGUA (LH)	1500 x 900	*		*	*
MARBELLA (RH)	1500 x 900	*		*	*
FLORIDA (LH)	1500 x 1000	*		*	*
NAUTILUS (RH)	1500 x 1000	*		*	*

2 WALL ANGLE FRONT

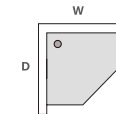

NAME
SIZE (mm)

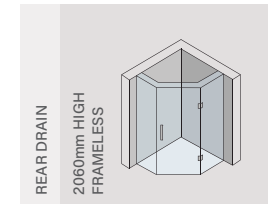

NAME	WIDTH	DEPTH	HINGED DOOR HA	
			REAR DRAIN	2060mm HIGH FRAMELESS
KOKOMO	900 x 900	*	*	*
LAGUNA	1000 x 1000	*	*	*

ANGLE FRONT SCREENS ARE REVERSIBLE

*2 WALL SCREENS INDICATED ARE REVERSIBLE

† OPTIONS INDICATED ARE STANDARD SLIDING SCREENS (NOT SOFT-CLOSE)



Black Pearl Laguna Hinged
Matte Black Hardware Upgrade
Ellure Tile Look Walls (Simply White)
EasyNiche Retrofit (White)
EasyNiche Recessed Towel Warmer

BLACK
PEARL™



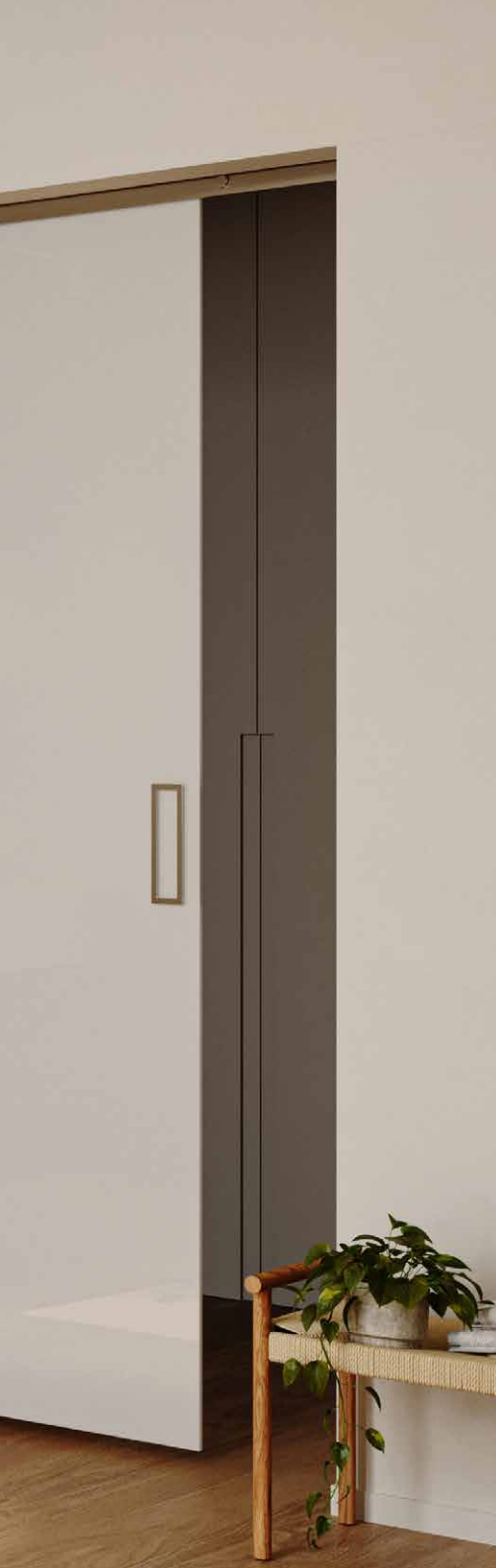

'Prefinished' Showers



QUUB™

Affordable style

QUUB™



Quub Mantra Hinged in Pure White
Ellure Tile Look Walls (Simply White)
EasyNiche Retrofit White

QUUB™

Affordable style

Choose Quub™ for a sleek and affordable prefinished shower by Atlantis – available in PureWhite or GraphiteBlack.

Rely on Quub™ for a solid tray that won't flex, generous wall upstands for guaranteed watertightness, stunning frameless screens @ 1960mm high and premium hardware.

Designed for NZ bathrooms, Quub™ is the mid-range acrylic shower designed to fit any budget and exceed all expectations.

Find Quub™ Technical Information on Pg. 91.

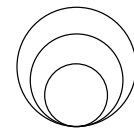

**7 YEAR
WARRANTY**



**NZ DESIGNED
& ASSEMBLED**

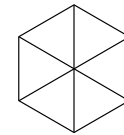

**DURABLE
CONSTRUCTION**

**QUUB FLOOR FINISHES
AVAILABLE:**

DEFAULT



**PURE WHITE
(GLOSS)**



**GRAPHITE BLACK
(MATTE)**

**QUUB HARDWARE
FINISHES AVAILABLE:**

DEFAULT

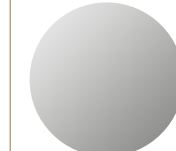

CHROME



MATTE BLACK

SEE PG. 67 FOR MORE INFO

3 WALL

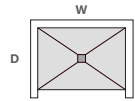

NAME
SIZE (mm)

CENTRE DRAIN

1960mm HIGH
FRAMELESS

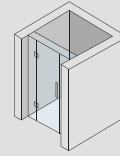

	WIDTH	DEPTH	HINGED DOOR F	
CHARISMA	900 x 900	•	•	•
LEISURE	1000 x 1000	•	•	•
GALAXY	1200 x 900	•	•	•
MUSE	1400 x 1000	•	•	•

ALL 3 WALL SCREENS ARE REVERSIBLE

2 WALL

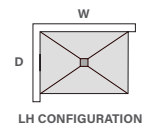

NAME
SIZE (mm)

CENTRE DRAIN

1960mm HIGH
FRAMELESS

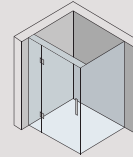

	WIDTH	DEPTH	HINGED DOOR B	
PARADIGM*	900 x 900	•	•	•
IDYLLIC*	1000 x 1000	•	•	•
BRAVO (LH)	1200 x 900	•	•	•
NIRVANA (RH)	1200 x 900	•	•	•
MAJESTIC (LH)	1400 x 1000	•	•	•
UTOPIA (RH)	1400 x 1000	•	•	•

*SCREENS INDICATED ARE REVERSIBLE

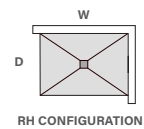

2 WALL ANGLE FRONT

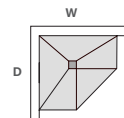

NAME
SIZE (mm)

CENTRE DRAIN

1960mm HIGH
FRAMELESS

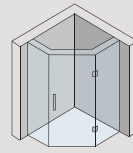

	WIDTH	DEPTH	HINGED DOOR HA	
DULCET	900 x 900	•	•	•
MANTRA	1000 x 1000	•	•	•

ANGLE FRONT SCREENS ARE REVERSIBLE

FIND TECHNICAL INFORMATION ON PG. 91. FIND ORDER FORMS ON PG. 99.

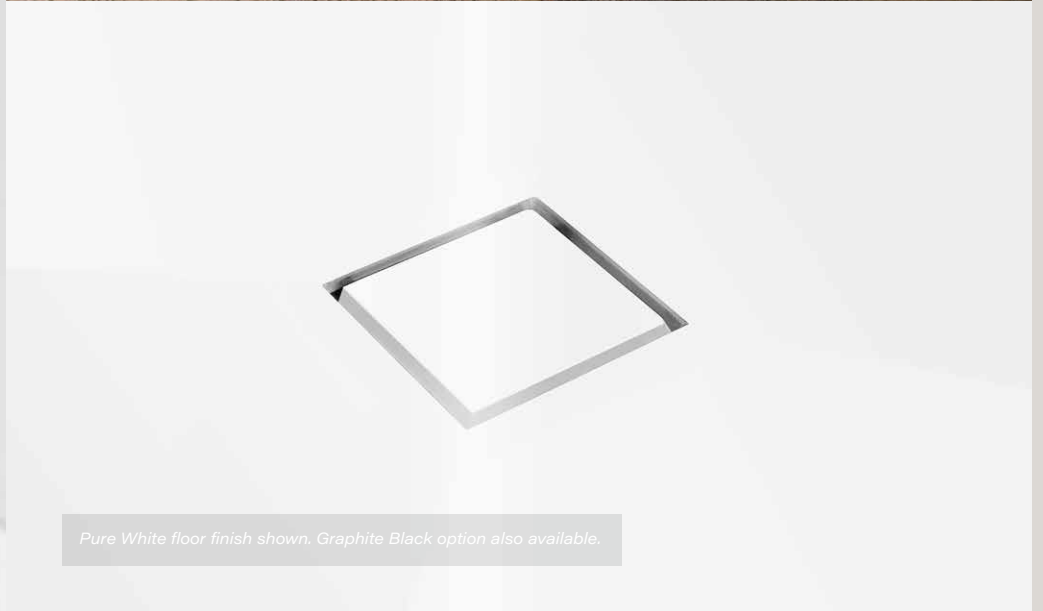

Pure White floor finish shown. Graphite Black option also available.





Screens Only (No Base)



NAKED FRAMELESS™

Endless possibilities



🔗 Naked Frameless™ 1200x900 Hinged Screens
EasyNiche Tiled 640x340

NAKED FRAMELESS™

Endless possibilities

Naked Frameless™ – Atlantis' range of beautiful frameless screens and quality components, exclusive to Linea Quattro™, Ebony & Ivory™ and Naked Frameless™.

Featuring quality hardware designed and assembled in NZ, Naked Frameless™ is supplied as an integrated system including all installation materials. Now available with the entire range of Foundry Series Hardware Upgrade finishes, there is a screen option for any bathroom. Supplied at 2120mm high and with CristalVision™ nano-protection for easy-clean screens.

Rely on a modular system from a single supplier with Naked Frameless™ by Atlantis.

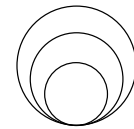

**7 YEAR
WARRANTY**

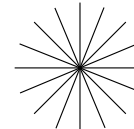

**HIGH QUALITY
COMPONENTRY**

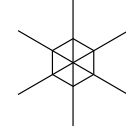

**CRISTALVISION
NANO-TREATED**

**NAKED FRAMELESS
STYLES AVAILABLE:**

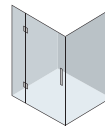

HINGED

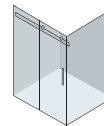

SLIDING

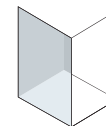

FIXED
(WALK-IN)

**NAKED FRAMELESS HARD-
WARE FINISHES AVAILABLE:**



CHR



BN



GM



MB

SEE PG. 67
FOR MORE
INFO



BG



PB



AB

3 WALL

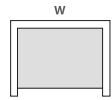

SIZE (mm)

2120mm HIGH
FRAMELESS

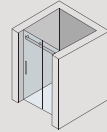
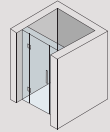

WIDTH	HINGED DOOR HR	SLIDING DOOR SL
900	•	
1000	•	
1100	•	•
1200	•	•
1300	•	•
1400	•	•
1500	•	•
1600	•	•
1700	•	•
1800	•	•
1900	•	•
2000	•	•

Nominal sizes only. Verify exact measurements at atlantis.co.nz

ALL 3 WALL SCREENS ARE REVERSIBLE

2 WALL ANGLE FRONT

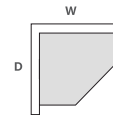

SIZE (mm)

2120mm HIGH
FRAMELESS

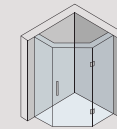

WIDTH	DEPTH	HINGED DOOR HR
900 x 900		•
1000 x 1000		•

Nominal sizes only. Verify exact measurements at atlantis.co.nz

ANGLE FRONT SCREENS ARE REVERSIBLE

FIXED PANEL 2 WALL OR 3 WALL

SIZE (mm)

2120mm HIGH
FRAMELESS

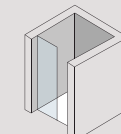
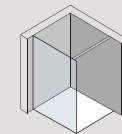

WIDTH	FIXED PANEL WALK-IN FX
570	•
670	•
870	•
970	•
1070	•
1170	•
1270	•
1370	•

Nominal sizes only. Verify exact measurements at atlantis.co.nz

FIXED PANELS ARE REVERSIBLE

2 WALL
800 DEEP
900 DEEP

SIZE (mm)

2120mm HIGH
FRAMELESS

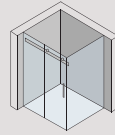
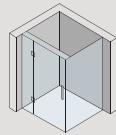

HINGED
DOOR HR

SLIDING
DOOR SL

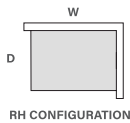
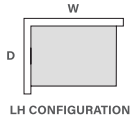

SIZE (mm)	HINGED DOOR HR	SLIDING DOOR SL
900 x 800	•	
1000 x 800	•	
1100 x 800	•	•
1200 x 800	•	•
1300 x 800	•	•
1400 x 800	•	•
1500 x 800		•
1600 x 800		•
1700 x 800		•
1800 x 800		•
1900 x 800		•
2000 x 800		•
900 x 900	•	
1000 x 900	•	
1100 x 900	•	•
1200 x 900	•	•
1300 x 900	•	•
1400 x 900	•	•
1500 x 900		•
1600 x 900		•
1700 x 900		•
1800 x 900		•
1900 x 900		•
2000 x 900		•

Nominal sizes only. Verify exact measurements at atlantis.co.nz

ALL 2 WALL SCREENS ARE REVERSIBLE*    

2 WALL
1000 DEEP
1100 DEEP
1200 DEEP
1300 DEEP
1400 DEEP

SIZE (mm)

2120mm HIGH
FRAMELESS

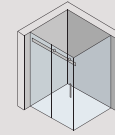
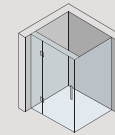

HINGED
DOOR HR

SLIDING
DOOR SL

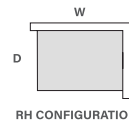
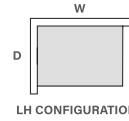

SIZE (mm)	HINGED DOOR HR	SLIDING DOOR SL
900 x 1000	•	
1000 x 1000	•	
1100 x 1000	•	•
1200 x 1000	•	•
1300 x 1000	•	•
1400 x 1000	•	•
1500 x 1000		•
1600 x 1000		•
1700 x 1000		•
1800 x 1000		•
1900 x 1000		•
2000 x 1000		•
1100 x 1100	•	
1200 x 1100	•	
1300 x 1100	•	•
1400 x 1100	•	•
1200 x 1200	•	•
1300 x 1200	•	•
1400 x 1200	•	•
1500 x 1200		•
1600 x 1200		•
1700 x 1200		•
1800 x 1200		•
1900 x 1200		•
2000 x 1200		•
1300 x 1300	•	
1400 x 1300	•	
1400 x 1400	•	

Nominal sizes only. Verify exact measurements at atlantis.co.nz

ALL 2 WALL SCREENS ARE REVERSIBLE*    

* DOOR LOCATED ON LONG SIDE OF SHOWER AS STANDARD UNLESS OTHERWISE SPECIFIED.

FIND ORDER FORMS ON PG. 100.





Extras

FINISHES & ACCESSORIES



🔗 Black Pearl Laguna Hinged
Matte Black Hardware Upgrade
Ellure Tile Look Walls – Subway
EasyNiche Retrofit (White)
EasyNiche Recessed Towel Warmer

ELLURE™ TILE LOOK WALLS

Simple. Smart. Stunning.

Create a bathroom with the clean lines and luxury look of tiles, while enjoying the ease of an acrylic wall.

The Ellure™ Tile Look Wall features sleek lines etched into a crisp white acrylic surface. Compatible with all Atlantis Shower Bases and Screens, the 2400mm high Ellure™ Walls are scaleable, creating infinite possibilities in sophisticated style.

Able to be installed in one site visit, Ellure™ Walls do not require waterproofing and any special building consents that may be associated with waterproofing. Easy-to-clean, 4.5mm thick panels @ 2400mm high, Ellure™ is simple, smart & stunning.

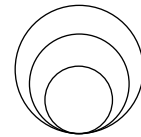

**7 YEAR
WARRANTY**



**NZ DESIGNED
& ASSEMBLED**

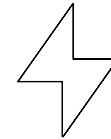

**QUICK & EASY
INSTALLATION**

**ELLURE™ WALL STYLES
AVAILABLE:**

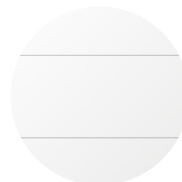

SIMPLY WHITE

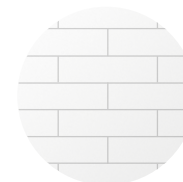

SUBWAY

**ELLURE™ WALL FINISHES
AVAILABLE:**



GLOSS WHITE



**SILK
(MATTE WHITE)**

2 WALL & ANGLE FRONT SHOWERS

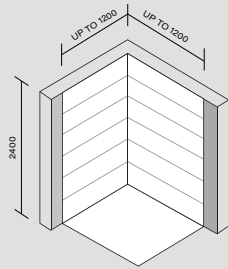

SMALL

UP TO 1200mm WIDE

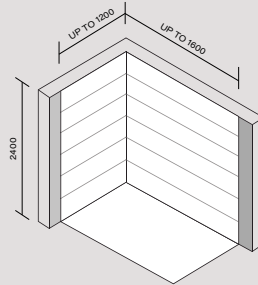

MEDIUM

1201-1600mm WIDE

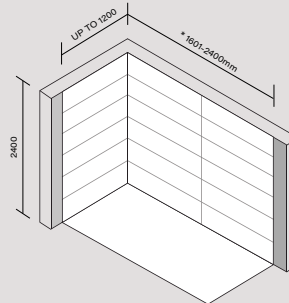

LARGE

*OVER 1601mm WIDE

SINGLE SHEETS

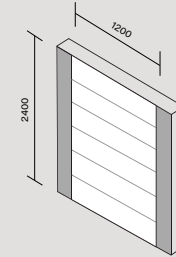

2400 x 1200mm

SIMPLY WHITE
SUBWAY

•
•

•
•

•
•

•
•

3 WALL SHOWERS

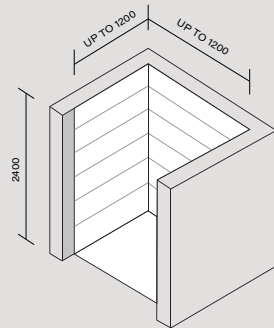

SMALL

UP TO 1200mm WIDE

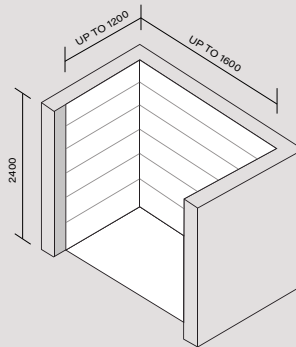

MEDIUM

1201-1600mm WIDE

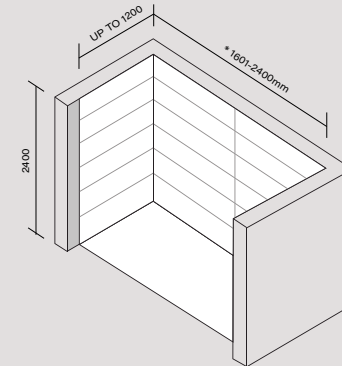

LARGE

*OVER 1601mm WIDE

SIMPLY WHITE
SUBWAY

•
•

•
•

•
•

*SHOWERS OVER 1601mm WIDE INCLUDE A DISCREET JOINTER IN MIDDLE OF LONG WALL

FIND ORDER FORMS ON PG. 102.



🔗 Black Pearl Bermuda Sliding
Ellure Tile Look Walls (Simply White)
EasyNiche Retrofit (White)
EasyNiche Recessed Towel Warmer

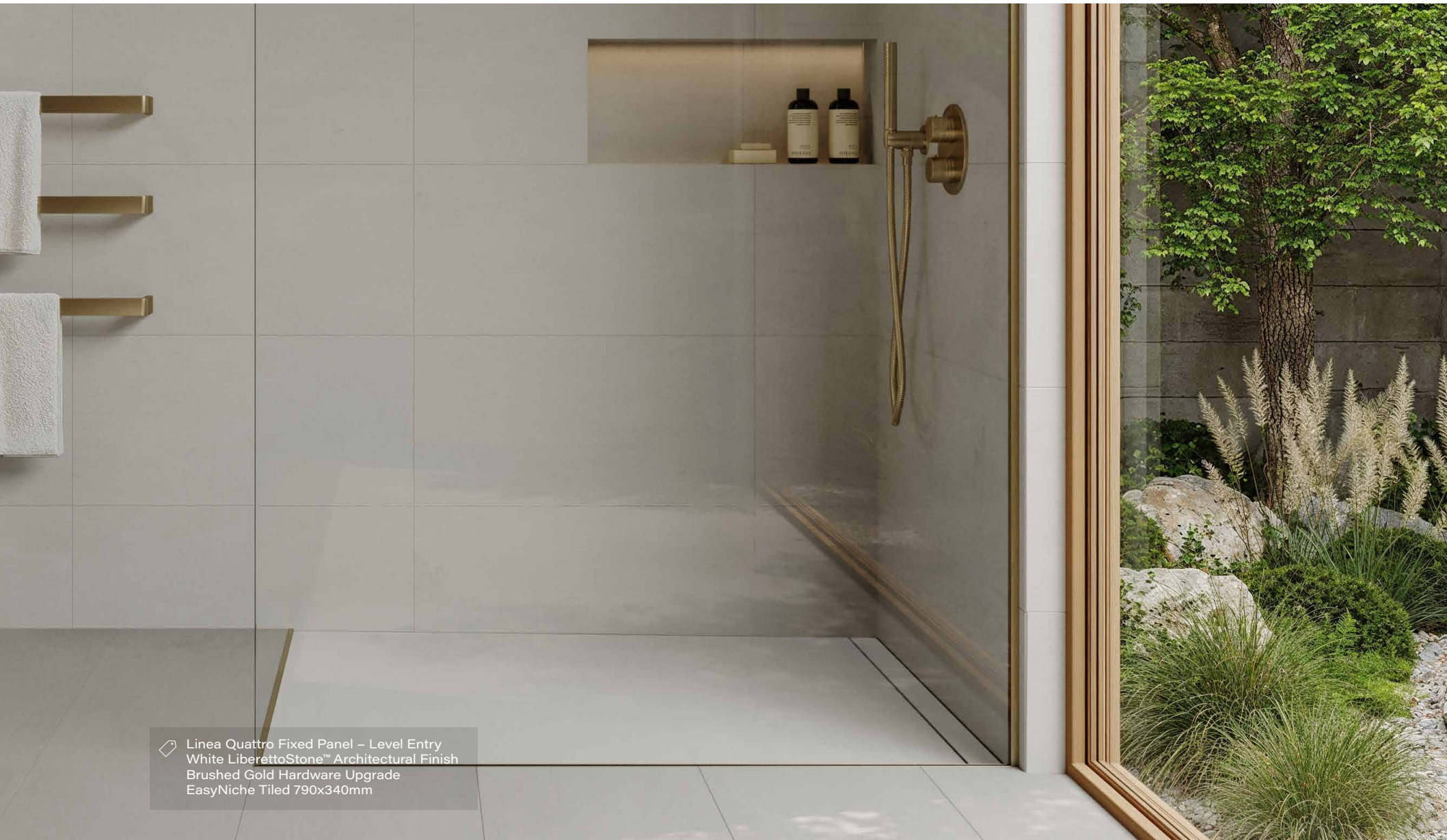

Linea Quattro Fixed Panel – Level Entry
White LiberettoStone™ Architectural Finish
Brushed Gold Hardware Upgrade
EasyNiche Tiled 790x340mm

ARCHITECTURAL FINISHES FOR LINEA QUATTRO TRAYS

Hassle-free floor finishes

Discover our range of premium floor surfaces, factory-fitted to any Linea Quattro™ channel drain shower base.

Available as an optional upgrade with any Linea Quattro™ Shower Base (including custom sizes), Architectural Finishes are one-piece surface overlays, factory-fitted to your tray. An excellent alternative to on-site tiling of the shower floor.

Architectural Finishes are made with LiberettoStone™ and may have natural variations and imperfections, adding uniqueness to your shower floor.

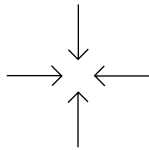

**FACTORY-FITTED TO
ANY LINEA QUATTRO TRAY**

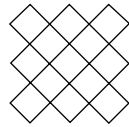

**ALTERNATIVE TO
ON-SITE TILING**

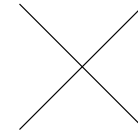

NO GROUT

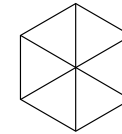

**ONE-PIECE
LIBERETTOSTONE**

ARCHITECTURAL FINISHES AVAILABLE:

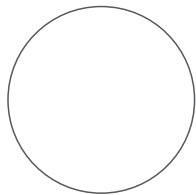

**WHITE
LIBERETTOSTONE™**



**CALACUTTA GOLD
LIBERETTOSTONE™**



**ALABASTER
PORCELAIN SLAB**



**SUNSTONE
LIBERETTOSTONE™**



**URBAN CONCRETE
LIBERETTOSTONE™**

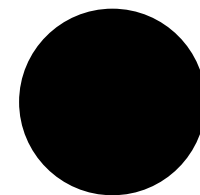

**BLACK
LIBERETTOSTONE™**



FOUNDRY SERIES HARDWARE

Create your extraordinary

Upgrade your shower hardware in Atlantis' stunning range of Foundry Series Hardware finishes.

All Brushed Nickel, Gunmetal and Brushed Gold components are *entirely PVD Stainless Steel*. Matte Black components are electroplated, and Aged & Polished Brass components are living brass finishes that will continue to patina gracefully for years to come. Polished Brass and Aged Brass are supplied with Matte Black Glazing Channels & Sliding Top Track.

Note: Not all finishes are available on all shower ranges. Please verify your desired finish is available on your selected shower.

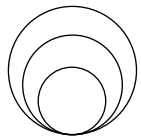

**5 YEAR
WARRANTY**



**NZ DESIGNED
& ASSEMBLED**

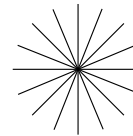

**HIGH QUALITY
COMPONENTRY**

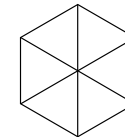

**DURABLE PVD
COATING***

FOUNDRY SERIES FINISHES AVAILABLE:

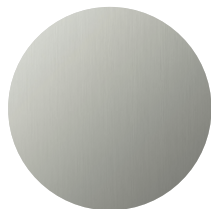

BN BRUSHED NICKEL

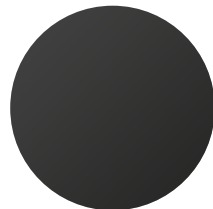

GM GUNMETAL

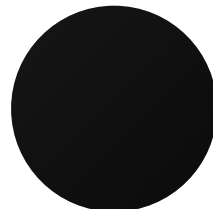

MB MATTE BLACK



BG BRUSHED GOLD

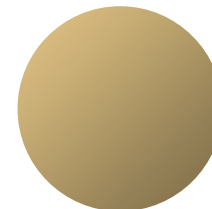

PB POLISHED BRASS*



AB AGED BRASS*

*POLISHED BRASS AND AGED BRASS FINISHES ARE SUPPLIED WITH MATTE BLACK GLAZING CHANNELS AND SLIDING TOP TRACK



EasyNiche Tiled 1500x340mm
Note: LED lighting not included

EASYNICHE™

Add the smart finishing touches

Add a touch of finesse to your bathroom with EasyNiche – smart storage solutions designed for NZ bathrooms.

From tile-over shampoo recesses to recessed 12V Heated Towel Rails, select the EasyNiche storage system for your space and rely on it's guaranteed performance for up to 25 years (warranties vary between product).

Explore in more detail why EasyNiche tile-over shelves have been NZ's trusted bathroom niche since 2008. Discover more about what sets EasyNiche apart on the following pages.

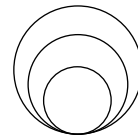

**UP TO 25 YEAR
WARRANTY**



**NZ DESIGNED
& ASSEMBLED**

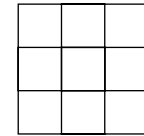

**DURABLE
CONSTRUCTION**

EASYNICHE™ STYLES AVAILABLE:



TILE-OVER



EXPOSED



RETROFIT



RECESSED TOWEL
WARMER

EASYNICHE™ TILE-OVER

The tilers choice for a 100% waterproof shelf or footrest unit.

- 100% Waterproof
- One-piece heavy-duty construction
- Built-in gradient prevents water ponding
- Fits in to 90mm wall cavity
- 65mm waterproofing flange

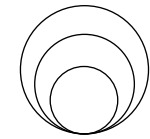

**25 YEAR
WARRANTY**

- Suitable for horizontal or vertical installation (except for footrest)
- Supplied with installation materials (including self-adhesive reinforcement band)
- 25 year leakfree warranty.

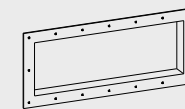

LARGE RECTANGLE

NOMINAL SIZE	WIDTH	HEIGHT	CODE
1500mm	1540 x 340		EN1500
1200mm	1240 x 340		EN1200
900mm	940 x 340		EN900
750mm	790 x 340		EN750

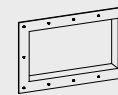

SMALL RECTANGLE

NOMINAL SIZE	WIDTH	HEIGHT	CODE
600mm	640 x 340		EN600
500mm	540 x 340		EN500
450mm	490 x 340		EN450
350mm	390 x 340		EN350
200mm	240 x 340		EN200



SQUARE

NOMINAL SIZE	WIDTH	HEIGHT	CODE
300mm	340 x 340		EN300



FOOTREST

NOMINAL SIZE	WIDTH	HEIGHT	CODE
140mm	180 x 120		EN140F

EASYNICHE™ EXPOSED

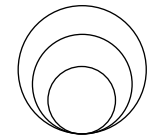

**7 YEAR
WARRANTY**

Create a shelf quickly and easily with an easy-to-clean acrylic interior.

- 100% Waterproof
- One-piece construction
- Built-in gradient prevents water ponding
- Fits in to 90mm wall cavity
- 65mm waterproofing flange
- Suitable for horizontal or vertical installation
- Supplied with installation materials (including self-adhesive reinforcement band)
- 7 year leakfree warranty.



SMALL RECTANGLE

WIDTH	HEIGHT	FINISH	CODE
400 x	300	GLOSS WHITE	EN400EX-W



EASYNICHE™ RETROFIT

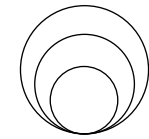

**7 YEAR
WARRANTY**

Incorporate a recess into your Acrylic Wall Liner, Ellure™ Tile Look Walls (or similar) with an EasyNiche™ Retrofit.

- 100% Waterproof
- One-piece construction
- Three finishes available
- Built-in gradient prevents water ponding
- Fits in to 90mm wall cavity
- Durable PMMA construction
- Suitable for horizontal or vertical installation (except for footrest)
- Supplied with installation materials
- 7 year durability warranty.



SMALL RECTANGLE

WIDTH	HEIGHT	FINISH	CODE
400 x 300		GLOSS WHITE	EN400RF-W
400 x 300		MATTE WHITE	EN400RF-SILK
400 x 300		GLOSS BLACK	EN400RF-B



FOOTREST

WIDTH	HEIGHT	FINISH	CODE
220 x 160		GLOSS WHITE	EN140RF-W
220 x 160		MATTE WHITE	EN140RF-SILK
220 x 160		GLOSS BLACK	EN140RF-B

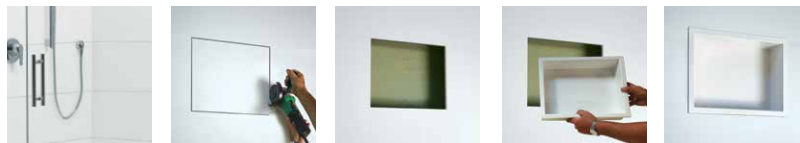

NEW EASYNICHE™ RECESSED TOWEL WARMER

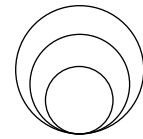

**7 YEAR
WARRANTY***

Incorporate a sleek towel ladder into your wall cavity with an EasyNiche™ Recessed Towel Warmer.

- Water resistant (IP45)
- Suitable for installation in Zone 2
- Durable Stainless Steel Recess in White or Black
- Stainless Steel Rails in Chrome or Matte Black
- Fits in to 90mm wall cavity
- Safe & Efficient 12V Heating
- Transformer included
- Supplied with installation materials
- 7 year durability warranty (*electrical components warranted for 12 months).

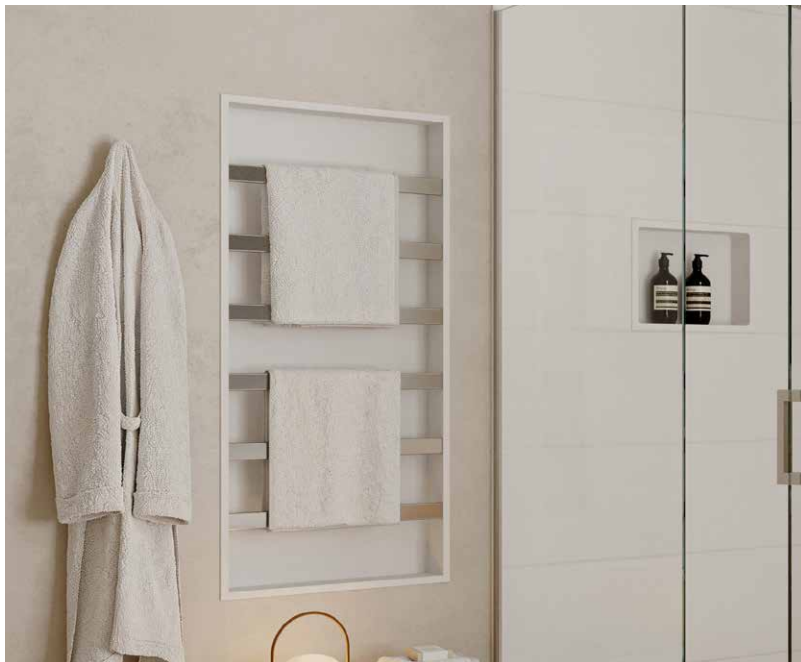

ONE SIZE ONLY

FINISH	WIDTH	HEIGHT	CODE
WHITE RECESS CHROME RAILS	600 x 1200		ENTW-RF612-W
WHITE RECESS BLACK RAILS	600 x 1200		ENTW-RF612-W-B
BLACK RECESS BLACK RAILS	600 x 1200		ENTW-RF612-B-B



Icona Chateau Heated Towel Poles in Aged Brass

ICONA™

Elevate your space

Elevate your bathroom in style with Icona™, Atlantis' range of premium heated towel rails & bathroom accessories.

Icona adds form and function to any bathroom design, with practical towel storage and safe 12V heating. Manufactured from 304 Stainless Steel & H59 Brass, Icona™ is designed and assembled in NZ, and built for the highest quality bathrooms.

Icona™ is available in 3 styles – Chateau, Mont & Arosa – in a number of formats and in several stunning PVD finishes, along with Living Brass Finishes for total cohesion, setting a benchmark in bathroom design.

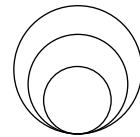

**5 YEAR
WARRANTY**



**NZ DESIGNED
& ASSEMBLED**

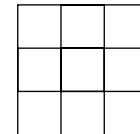

**SAFE 12V
HEATING**

ICONA™ STYLES
AVAILABLE:



CHATEAU



MONT



AROSA

ICONA™ FINISHES
AVAILABLE:



CHR



BN



GM



MB



MW



BG



PB



AB

Note: finishes available depends on style selected

ICONA™ CHATEAU RAIL

The simple, timeless rail design. Add Chateau for a beautifully proportioned design that works in any space.

- Stainless Steel/H59 Brass Construction
- Safe & efficient 12V heating
- IP44 (Suitable for installation in Zone 2)
- NZ designed & assembled

- Supplied with installation materials
- 5 year durability warranty (*electrical components warranted for 12 months).

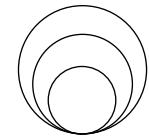

5 YEAR WARRANTY*

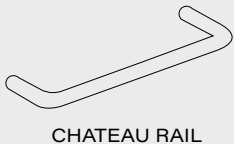

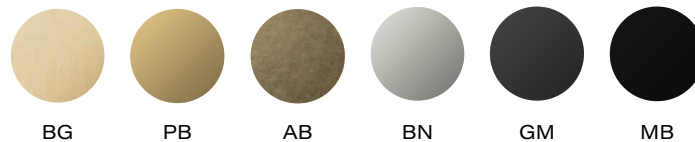

FINISH	SIZE		
	450mm	600mm	800mm
BRUSHED GOLD	•	•	•
POLISHED BRASS	•	•	•
AGED BRASS	•	•	•
BRUSHED NICKEL	•	•	•
GUNMETAL	•	•	•
MATTE BLACK	•	•	•

CHATEAU RAIL FINISHES AVAILABLE:

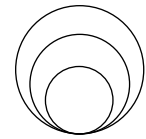

ICONA™ CHATEAU POLE



**5 YEAR
WARRANTY***

The Chateau Pole combines the stunning Chateau silhouette with the practicality of the vertical heated rail.

- Stainless Steel/H59 Brass Construction
- Safe & efficient 12V heating
- IP44 (Suitable for installation in Zone 2)
- NZ designed & assembled
- Supplied with installation materials
- 5 year durability warranty (*electrical components warranted for 12 months).



FINISH	SIZE
	1000mm
MATTE WHITE	•
BRUSHED GOLD	•
POLISHED BRASS	•
AGED BRASS	•
CHROME	•
BRUSHED NICKEL	•
GUNMETAL	•
MATTE BLACK	•

CHATEAU POLE

CHATEAU POLE FINISHES AVAILABLE:

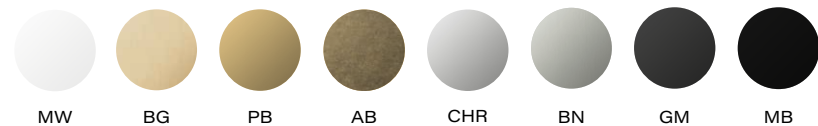

ICONA™ MONT RAIL

Modern, refined and elegant, Mont is the perfect addition to any bathroom.

- Stainless Steel Construction
- Safe & efficient 12V heating
- IP44 (Suitable for installation in Zone 2)
- NZ designed & assembled

- Supplied with installation materials
- 5 year durability warranty (*electrical components warranted for 12 months).

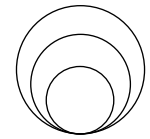

5 YEAR WARRANTY*

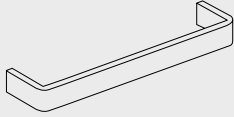
MONT RAIL

FINISH	SIZE		
	450mm	600mm	800mm
CHROME	.	.	.
BRUSHED NICKEL	.	.	.
GUNMETAL	.	.	.
MATTE BLACK	.	.	.

MONT RAIL FINISHES AVAILABLE:

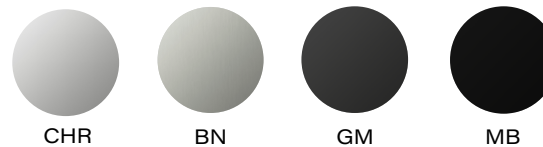

ICONA™ MONT POLE

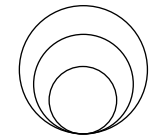

**5 YEAR
WARRANTY***

Sleek and modern, the Mont Pole is equal parts practical and awe-inspiring.

- Stainless Steel Construction
- Safe & efficient 12V heating
- IP44 (Suitable for installation in Zone 2)
- NZ designed & assembled
- Supplied with installation materials
- 5 year durability warranty (*electrical components warranted for 12 months).



FINISH	SIZE
BRUSHED GOLD	1000mm
CHROME	•
BRUSHED NICKEL	•
GUNMETAL	•
MATTE BLACK	•

MONT POLE

MONT POLE FINISHES AVAILABLE:

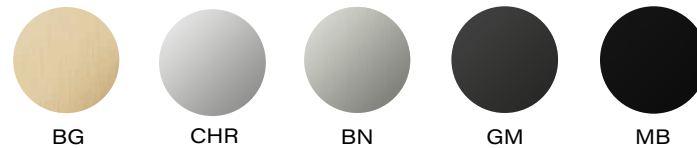

BG

CHR

BN

GM

MB

ICONA™ AROSA RAIL

Arosa is a hit, and rightly so. A classic towel rail design, Arosa is perfectly balanced.

- Stainless Steel Construction
- Safe & efficient 12V heating
- IP44 (Suitable for installation in Zone 2)
- NZ designed & assembled

- Supplied with installation materials
- 5 year durability warranty (*electrical components warranted for 12 months).

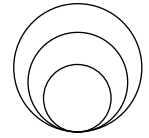

5 YEAR WARRANTY*



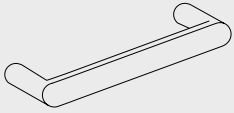

FINISH	SIZE		
	600mm	800mm	1000mm
MATTE WHITE	•	•	•
CHROME	•	•	•
BRUSHED NICKEL	•	•	•
MATTE BLACK	•	•	•

AROSA RAIL

AROSA RAIL FINISHES AVAILABLE:

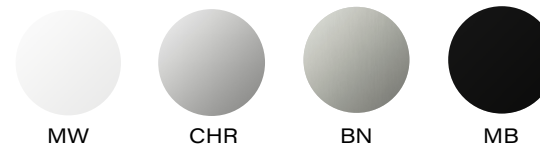

ICONA™ ACCESSORIES

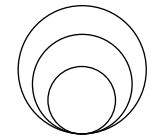

**5 YEAR
WARRANTY**

Accessories are available in Chateau and Mont styles.

Included in the package is: 1x Robe Hook, 1x Toilet Roll Holder & 1x Spare Toilet Roll Holder.

- Stainless Steel/H59 Brass Construction
- NZ designed & assembled
- Also available for purchase individually
- Supplied with installation materials
- 5 year durability warranty

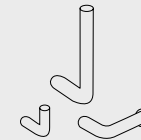

CHATEAU
ACCESSORY
PACK

FINISH	STYLE		
	ROBE HOOK	TOILET ROLL HOLDER	SPARE ROLL HOLDER
BRUSHED GOLD	•	•	•
POLISHED BRASS	•	•	•
AGED BRASS	•	•	•
CHROME	•	•	•
BRUSHED NICKEL	•	•	•
GUNMETAL	•	•	•
MATTE BLACK	•	•	•

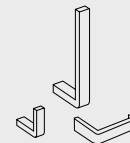

MONT
ACCESSORY
PACK

FINISH	STYLE		
	ROBE HOOK	TOILET ROLL HOLDER	SPARE ROLL HOLDER
CHROME	•	•	•
BRUSHED NICKEL	•	•	•
GUNMETAL	•	•	•
MATTE BLACK	•	•	•





Resources

WARRANTY & TECHNICAL

ATLANTIS PRODUCT WARRANTIES

Atlantis Bathroom Style Ltd proudly warrants products or product components manufactured and distributed by Atlantis meet or exceed the standard requirements of the New Zealand Building Code; and will be free from inherent defects in materials and workmanship for the extended warranty period applicable to the Product (see below):

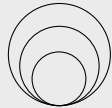

25 YEAR WARRANTY

- Linea Quattro™ Shower Base
- EasyTile™ Shower Base
- EasyNiche™ Tile-Over
- Accessible Shower Base (excl. Seamless Entry)

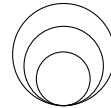

10 YEAR WARRANTY

- Ebony & Ivory™ Shower Base
- Verve™ Shower Base

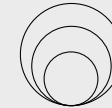

7 YEAR WARRANTY

- Black Pearl™ Shower Base
- Quub™ Shower Base
- EasyNiche™ Exposed & Retrofit
- EasyNiche™ Towel Warmer (excl. Electrical Components)
- Ellure™ Walls & Acrylic Liners

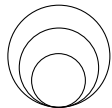

5 YEAR WARRANTY

- Shower Hardware (incl. Foundry Series Hardware)
- Atlantis Toughened Glass* (incl. CristalVision Coating)
- Icona Heated Towel Rails (excl. Electrical Components)



2 YEAR WARRANTY

- LiberettoStone Architectural Finishes

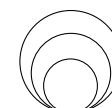

12 MONTH WARRANTY

- Electrical Components

*T&Cs Apply to Glass Warranty. Visit atlantis.co.nz/warranty for more information

LEAK-FREE WARRANTY

When the shower components are installed in accordance with the manufacturer's instructions, Atlantis Bathroom Style Ltd warrants that the tile-over shower base will not allow water leakage* into the building structure for a minimum period of 25 years. *Water leakage excludes surface splashes.

The liability of the company is limited to the replacement of products (or system components) for an equivalent product, and the installation thereof provided the product or component is declared defective by an authorised representative of the company. The company will not be liable for any damages or losses beyond the installation of replacement products as originally supplied. Under no circumstances will the company be liable for consequential or incidental damages related to the use of this product.

DO NOT install a damaged or defective product. Use only the primers, adhesives and silicone sealants supplied with this product, as directed, for the installation of this product.

Apply an approved waterproofing membrane, to the walls. Use only the recommended tile adhesives compatible with selected membrane. Failure to comply may deem this warranty void.

This warranty will not apply where the Products have been improperly installed, have been misused or proof of purchase cannot be provided. The leak-free warranty may not apply where the warranty claim has not been notified to the company within 90 days of the problem first appearing or where any system component is substituted without the company's express agreement.

For more information including Terms & Conditions, visit atlantis.co.nz/warranty

INSTALLATION WARRANTY

As offered by your independent contractor/installer. An Atlantis recommended installer should offer a minimum 5-year installation guarantee for workmanship. Please check before proceeding with any part of this installation. Find your nearest Recommended Shower Installer at atlantis.co.nz/find-an-installer

While we highly suggest using a Recommended Shower Installer, Atlantis product warranties apply regardless of who installs the product provided manufacturers installation instructions have been followed. Installation warranty not offered by Atlantis.

Note: Atlantis reserves the right to change product specifications without notice.

LINEA QUATTRO™ SHOWER SYSTEM SPECIFICATION

The Linea Quattro™ Shower System is Atlantis' flagship Tiled Shower System, boasting an incredible 25 year leakfree warranty, market-leading screen height and premium hardware – there are truly no comparisons to Linea Quattro™.

SHOWER BASE

- Ready-to-tile structurally solid pre-formed base made of tough fibreglass-reinforced acrylic, already 100% waterproof
- 25-year leakfree warranty on base
- TANZ Appraised (Tile Association of NZ)
- Suitable for installation on timber or concrete floor
- May be installed to achieve a stepless shower floor (Level Entry) or simply placed on an existing floor for low step entry (Step Entry)
- 100mm high upstand from floor – for secure connection to wall membrane
- Factory-fitted glass receiver channels on base
- Guaranteed fall (1:80) to waste
- Single plane to channel drain surface accepts tiles up to 12mm thick (standard)
- Weight: 20kg/m²

CHANNEL DRAIN & WASTE FITTING

- Integral channel drain located at side or back
- 40/50mm EasyClean Waste outlet
- Minimum flow rate 40 litres per minute
- Tile-Over Stainless steel drain cover as standard

PRECISION-FIT FRAMELESS SCREENS

- 8mm toughened safety glass
- CristalCote Nano-Coating factory-applied
- Hinged door option complete with chrome/stainless steel handles, solid brass hinges and fixing materials
- Sliding door option complete with stainless steel handles, roller assemblies and installation materials
- High strength top rail brace at 2000mm high above base on sliding screen
- Walk-in fixed panel options available in most sizes
- Wall glass receiver channels incorporate mechanical glass locking system and are designed to interlock with base glazing channels
- Screens supplied at 2120mm overall height

INSTALLATION

- Atlantis recommends installation of Linea Quattro™ Showers is undertaken by a recommended Atlantis Shower installer. See website or call 0800 428 526 for more details.

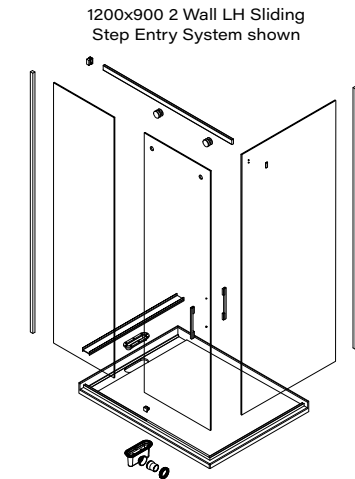

CAD Files available. Visit atlantis.co.nz to download.

LINEA QUATTRO™ STEP ENTRY BASE ON ANY FLOOR STRUCTURE

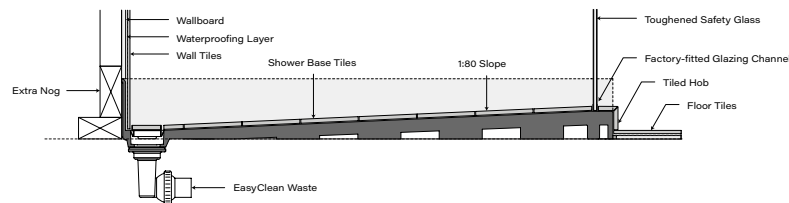

LINEA QUATTRO™ LEVEL ENTRY BASE IN TIMBER FLOOR STRUCTURE

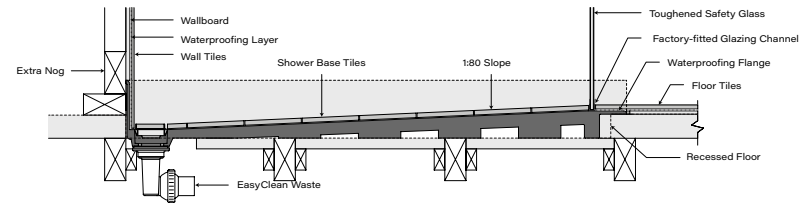

Generic profiles only. Visit atlantis.co.nz for more information.

EASYTILE™ SHOWER SYSTEM SPECIFICATION

The EasyTile™ Shower System is New Zealand's original tile-over shower system. Designed as a fail-safe method to tiling showers over 25 years ago, tens of thousands of Kiwi's enjoy peace-of-mind when showering in an EasyTile™ Shower daily.

SHOWER BASE

- Ready-to-tile structurally solid pre-formed base made of tough fibreglass-reinforced acrylic, already 100% waterproof
- 25-year leakfree warranty on base
- TANZ Appraised (Tile Association of NZ)
- Square tile-in drain outlet located at centre
- Wall junction upstand 85mm high from floor
- Seepage ports incorporated with drain
- No floor structural modifications required
- Shower base comes with factory-fitted glazing channels
- Weight: 16kg/m2

WASTE FITTING

- 40mm EasyClean Waste supplied (HiFlow Waste can be supplied by special request)
- Tile-Over Stainless steel drain cover as standard

PRECISION-FIT FRAMELESS SCREENS

- 8mm toughened safety glass
- Wall glass receiver channels incorporate mechanical glass locking system and interlock with base glazing channel
- Stainless 'E Handle' supplied as standard
- Adjustable bracing system – catering for uneven walls, incorporating up to +/-10mm installation tolerance.
- Chromed solid brass self-centering hinges supplied
- Screens supplied at 1920mm overall height

INSTALLATION

- Atlantis recommends installation of EasyTile™ Showers is undertaken by a recommended Atlantis Shower installer. See website or call 0800 428 526 for more details.

1000x1000 2 Wall Hinged System shown

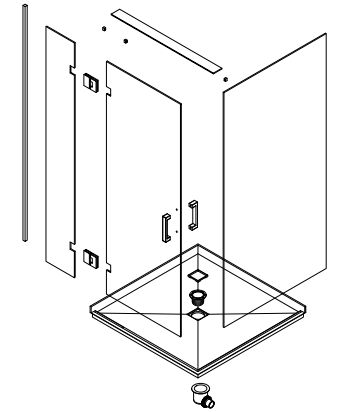

CAD Files available. Visit atlantis.co.nz to download.

EASYTILE™ BASE ON ANY FLOOR STRUCTURE

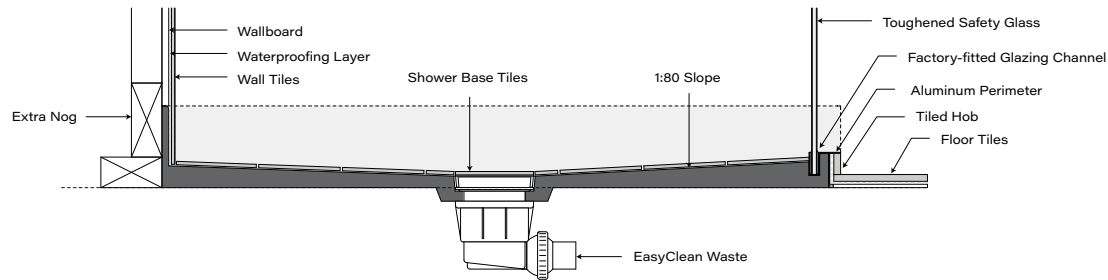

Generic profiles only. Visit atlantis.co.nz for more information.

EBONY & IVORY™ SHOWER SYSTEM SPECIFICATION

The Ebony & Ivory™ Shower System is Atlantis' premium 'prefinished' shower tray. Featuring a solid Stone Shower Tray, Ebony & Ivory™ is designed for dramatic effect. Choose either a Black or White Tray to complement or contrast your bathroom design.

SHOWER BASE

- One piece preformed LiberettoStone™ construction for durable performance
- Base available in Black (Ebony) or White (Ivory) LiberettoStone™
- Structurally strong across entire base and outlet – will not deflect or compress
- Wall junction upstand 100mm high
- Base height 35mm maximum (floor to top of base)
- 10 year leak-free and durability warranty
- Weight: 45kg/m²

MINI-CHANNEL & WASTE FITTING

- Integral mini-channel drain located at side (350x60mm LiberettoStone™ Drain Cover @ 150mm off wall)
- 40/50mm EasyClean Waste outlet
- Minimum flow rate 40 litres per minute

PRECISION-FIT FRAMELESS SCREENS

- 8mm toughened safety glass
- CristalCote Nano-Coating factory-applied
- Hinged door option complete with chrome/stainless steel handles, solid brass hinges and fixing materials
- Sliding door option complete with stainless steel handles, roller assemblies and installation materials
- High strength top rail brace at 2000mm high above base on sliding screen
- Walk-in fixed panel options available in most sizes
- Wall glass receiver channels incorporate mechanical glass locking system and are designed to interlock with base glazing channels
- Screens supplied at 2120mm overall height

INSTALLATION

- Atlantis recommends installation of Ebony & Ivory™ Showers is undertaken by a recommended Atlantis Shower installer. See website or call 0800 428 526 for more details.

1200x900 2 Wall LH Hinged System shown

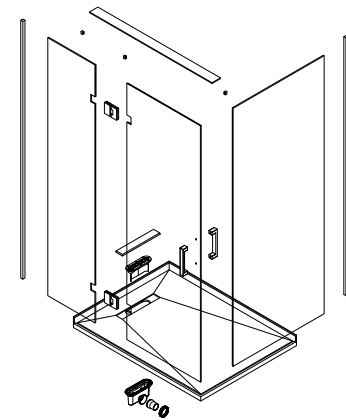

CAD Files available. Visit atlantis.co.nz to download.

EBONY & IVORY™ BASE ON ANY FLOOR STRUCTURE

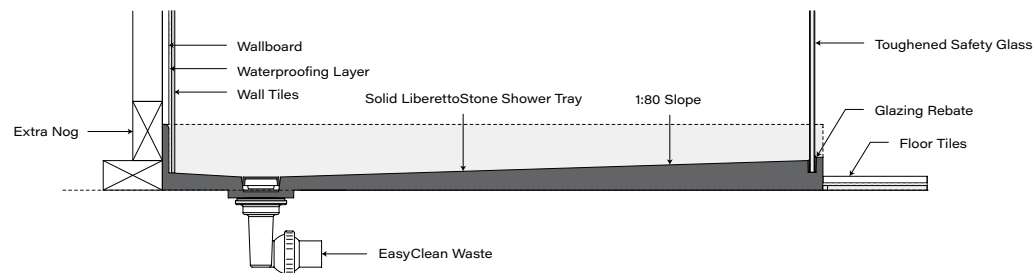

Generic profile only. Visit atlantis.co.nz for more information.

VERVE™ SHOWER SYSTEM SPECIFICATION

The all-new Verve™ Shower by Atlantis is the latest addition to our 'prefinished' shower lineup. Featuring a top-of-class sleek *matte* acrylic shower tray, ultra-low profile base design & waste top and beautiful CristalVision™ screens.

SHOWER BASE

- Structurally solid pre-formed base made of tough fibreglass-reinforced acrylic
- Matte acrylic surface available in three sleek finishes (Silk, Ash & Charcoal)
- 100mm high upstand from floor – for secure connection to wall lining or membrane
- Guaranteed fall (1:80) to waste
- Base height 32mm maximum (floor to top of base)
- 10 year leak-free and durability warranty
- Weight: 16kg/m²

WASTE TOP & WASTE FITTING

- 40mm EasyClean Waste supplied (HiFlow Waste can be supplied by special request)
- Matte acrylic waste top in finish matched to tray (Silk, Ash & Charcoal)

PRECISION-FIT FRAMELESS SCREENS

- 8mm toughened safety glass
- CristalCote Nano-Coating factory-applied
- Hinged door option complete with chrome/stainless steel handles, solid brass hinges and fixing materials
- Sliding door option complete with stainless steel handles, roller assemblies and installation materials
- High strength top rail brace at 2000mm high above base on sliding screen
- Wall glass receiver channels incorporate mechanical glass locking system
- Screens supplied at 2023mm overall height*
- *Sliding screen rollers are 2090mm overall height

INSTALLATION

- Atlantis recommends installation of Verve™ Showers is undertaken by a recommended Atlantis installer. See website or call 0800 428 526 for more details.

1200x900 2 Wall LH Sliding System shown

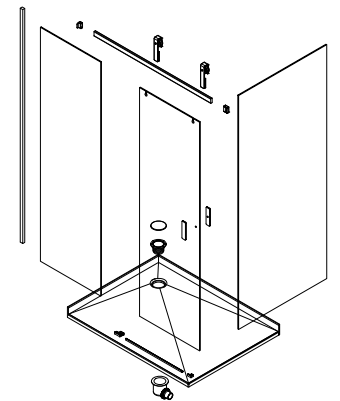

 CAD Files available. Visit atlantis.co.nz to download.

VERVE BASE ON ANY FLOOR STRUCTURE

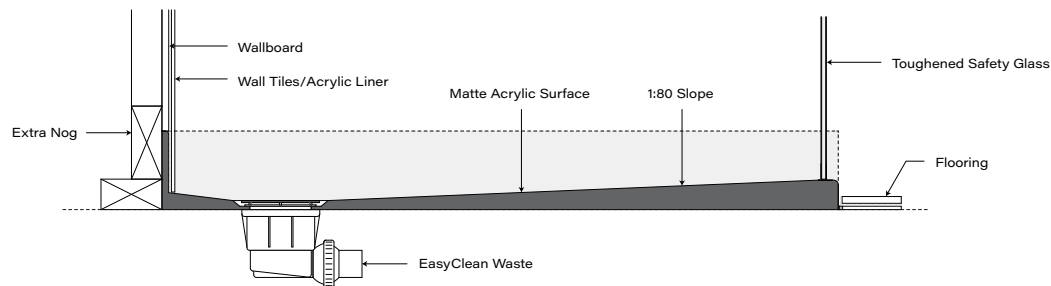

Generic profile only. Visit atlantis.co.nz for more information.

BLACK PEARL™ SHOWER SYSTEM SPECIFICATION

The Black Pearl™ Shower is an acrylic shower, a cut above the rest. With CristalVision Nano-Coated frameless glass in either Soft-Close Sliding Screens or Frameless Hinged, Black Pearl is a premium acrylic shower fit for modern bathrooms.

SHOWER BASE

- Structurally solid pre-formed base made of tough fibreglass-reinforced acrylic
- Gloss White acrylic surface
- 100mm high upstand from floor – for secure connection to wall lining or membrane
- Guaranteed fall (1:80) to waste
- Base height 55mm maximum (floor to top of base glazing channel)
- Shower base comes with factory-fitted glazing channels
- 7 year leak-free and durability warranty
- Weight: 16kg/m²

WASTE TOP & WASTE FITTING

- 40mm EasyClean Waste supplied (HiFlow Waste can be supplied by special request)
- Machined Stainless Steel Waste Top

PRECISION-FIT FRAMELESS SCREENS

- 8mm toughened safety glass
- CristalCote Nano-Coating factory-applied
- Wall glass receiver channels incorporate mechanical glass locking system and interlock with base glazing channel
- Hinged door option complete with chrome/stainless steel handles, solid brass hinges and fixing materials
- Soft-close sliding door option complete with stainless steel handles, roller assemblies and installation materials
- Concealed soft-close track and mechanism on sliding screen
- Screens supplied at 2023mm overall height

INSTALLATION

- Atlantis recommends installation of Black Pearl™ Showers is undertaken by a recommended Atlantis Shower installer. See website or call 0800 428 526 for more details.

1200x900 2 Wall LH Sliding System shown

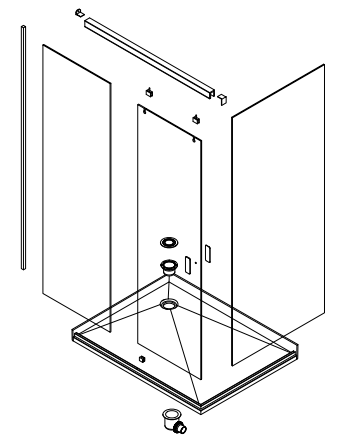

CAD Files available. Visit atlantis.co.nz to download.

BLACK PEARL™ BASE ON ANY FLOOR STRUCTURE

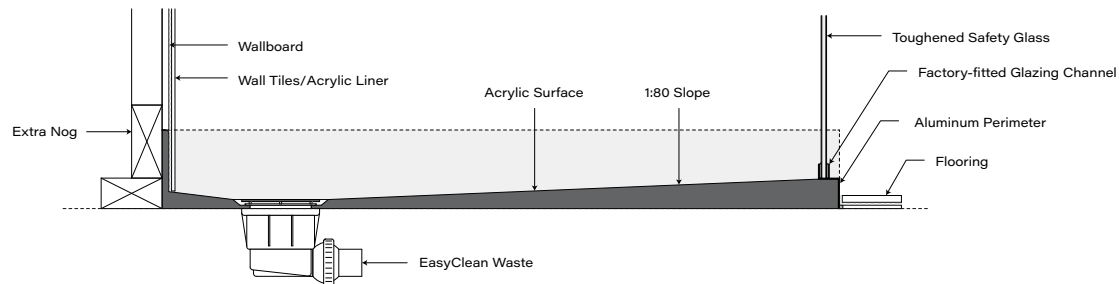

Generic profiles only. Visit atlantis.co.nz for more information.

QUUB™ SHOWER SYSTEM SPECIFICATION

The Quub™ Shower System is Atlantis' mid-range acrylic shower – designed for NZ bathrooms. Rely on Quub™ for a solid tray that won't flex, generous wall upstands for guaranteed watertightness, stunning frameless screens and premium hardware.

SHOWER BASE

- Structurally solid pre-formed base made of tough fibreglass-reinforced acrylic
- Acrylic surface available in two finishes – Pure White (Gloss) or Graphite Black (Matte)
- 100mm high upstand from floor – for secure connection to wall lining or membrane
- Guaranteed fall (1:80) to waste
- Shower base comes with factory-fitted glazing channels
- 7 year leak-free and durability warranty
- Weight: 16kg/m²

WASTE TOP & WASTE FITTING

- 40mm EasyClean Waste supplied (HiFlow Waste can be supplied by special request)
- Acrylic waste top in finish matched to tray (Pure White or Graphite Black)

PRECISION-FIT FRAMELESS SCREENS

- 8mm toughened safety glass
- Wall glass receiver channels incorporate mechanical glass locking system and interlock with base glazing channel
- Stainless 'E Handle' supplied as standard
- Adjustable bracing system – catering for uneven walls, incorporating up to +/-10mm installation tolerance.
- Chromed solid brass self-centering hinges supplied
- Screens supplied at 1920mm overall height

INSTALLATION

- Atlantis recommends installation of Quub™ Showers is undertaken by a recommended Atlantis Shower installer. See website or call 0800 428 526 for more details.

1200x900 2 Wall Hinged System shown

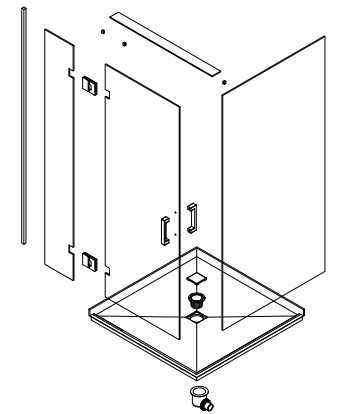

 CAD Files available. Visit atlantis.co.nz to download.

QUUB™ BASE ON ANY FLOOR STRUCTURE

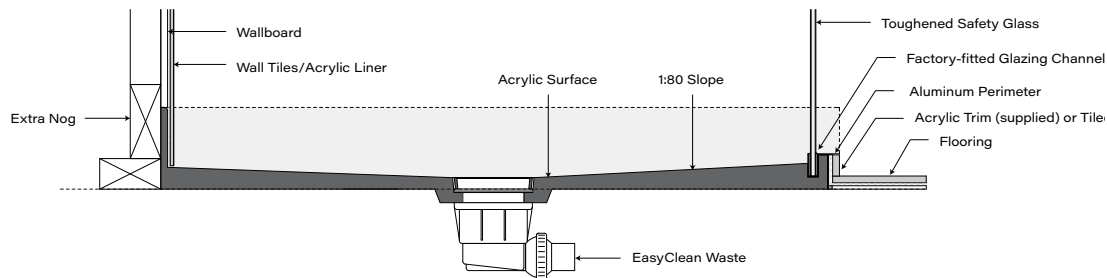

Generic profile only. Visit atlantis.co.nz for more information.

LINEA QUATTRO ORDER FORMS (1/3)

3 WALL 800 DEEP

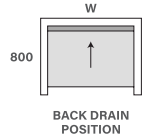

NAME
SIZE (mm)

BACK DRAIN

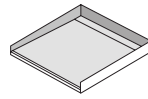

2160mm HIGH
FRAMELESS

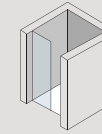
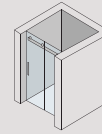
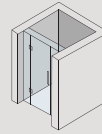

BASE & WASTE ONLY
NO SCREEN

BASE, WASTE &
HINGED DOOR HR

BASE, WASTE &
SLIDING DOOR SL

BASE, WASTE &
FIXED PANEL FX

	WIDTH	DEPTH		CODE		CODE		CODE		CODE
PRAGUE	900 x 800	<input type="checkbox"/>		LQ-PRA	<input type="checkbox"/>	PRA-HR	<input type="checkbox"/>	-	-	-
DALLAS	1000 x 800	<input type="checkbox"/>		LQ-DAL	<input type="checkbox"/>	DAL-HR	<input type="checkbox"/>	-	-	-
BEIJING	1100 x 800	<input type="checkbox"/>		LQ-BEI	<input type="checkbox"/>	BEI-HR	<input type="checkbox"/>	BEI-SL	<input type="checkbox"/>	-
STOCKHOLM	1200 x 800	<input type="checkbox"/>		LQ-STO	<input type="checkbox"/>	STO-HR	<input type="checkbox"/>	STO-SL	<input type="checkbox"/>	STO-FX
LINCOLN	1300 x 800	<input type="checkbox"/>		LQ-LIN	<input type="checkbox"/>	LIN-HR	<input type="checkbox"/>	LIN-SL	<input type="checkbox"/>	LIN-FX
MOSCOW	1400 x 800	<input type="checkbox"/>		LQ-MOS	<input type="checkbox"/>	MOS-HR	<input type="checkbox"/>	MOS-SL	<input type="checkbox"/>	MOS-FX
WASHINGTON	1500 x 800	<input type="checkbox"/>		LQ-WAS	<input type="checkbox"/>	WAS-HR	<input type="checkbox"/>	WAS-SL	<input type="checkbox"/>	WAS-FX
BUDAPEST	1600 x 800	<input type="checkbox"/>		LQ-BUD	<input type="checkbox"/>	BUD-HR	<input type="checkbox"/>	BUD-SL	<input type="checkbox"/>	BUD-FX
AMSTERDAM	1700 x 800	<input type="checkbox"/>		LQ-AMS	<input type="checkbox"/>	AMS-HR	<input type="checkbox"/>	AMS-SL	<input type="checkbox"/>	AMS-FX
COPENHAGEN	1800 x 800	<input type="checkbox"/>		LQ-COP	<input type="checkbox"/>	COP-HR	<input type="checkbox"/>	COP-SL	<input type="checkbox"/>	COP-FX
HAVANA	1900 x 800	<input type="checkbox"/>		LQ-HAV	<input type="checkbox"/>	HAV-HR	<input type="checkbox"/>	HAV-SL	<input type="checkbox"/>	HAV-FX
SEOUL	2000 x 800	<input type="checkbox"/>		LQ-SEO	<input type="checkbox"/>	SEO-HR	<input type="checkbox"/>	SEO-SL	<input type="checkbox"/>	SEO-FX

3 WALL 900 DEEP

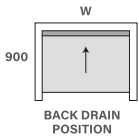

NAME
SIZE (mm)

LH DRAIN
RH DRAIN
BACK DRAIN

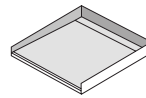

2160mm HIGH
FRAMELESS

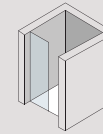
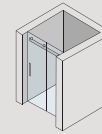
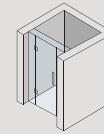

BASE & WASTE ONLY
NO SCREEN

BASE, WASTE &
HINGED DOOR HR

BASE, WASTE &
SLIDING DOOR SL

BASE, WASTE &
FIXED PANEL FX

	WIDTH	DEPTH		CODE		CODE		CODE		CODE
ROME	900 x 900	<input type="checkbox"/>		LQ-ROM	<input type="checkbox"/>	ROM-HR	<input type="checkbox"/>	-	-	-
TURIN	1000 x 900	<input type="checkbox"/>	<input type="checkbox"/>	LQ-TUR	<input type="checkbox"/>	TUR-HR	<input type="checkbox"/>	-	-	-
ZURICH	1100 x 900	<input type="checkbox"/>		LQ-ZUR	<input type="checkbox"/>	ZUR-HR	<input type="checkbox"/>	ZUR-SL	<input type="checkbox"/>	-
BERLIN	1200 x 900	<input type="checkbox"/>	<input type="checkbox"/>	LQ-BER	<input type="checkbox"/>	BER-HR	<input type="checkbox"/>	BER-SL	<input type="checkbox"/>	BER-FX
VIENNA	1300 x 900	<input type="checkbox"/>		LQ-VIE	<input type="checkbox"/>	VIE-HR	<input type="checkbox"/>	VIE-SL	<input type="checkbox"/>	VIE-FX
SANTIAGO	1400 x 900	<input type="checkbox"/>	<input type="checkbox"/>	LQ-SAN	<input type="checkbox"/>	SAN-HR	<input type="checkbox"/>	SAN-SL	<input type="checkbox"/>	SAN-FX
BARCELONA	1500 x 900	<input type="checkbox"/>	<input type="checkbox"/>	LQ-BAR	<input type="checkbox"/>	BAR-HR	<input type="checkbox"/>	BAR-SL	<input type="checkbox"/>	BAR-FX
OTTAWA	1600 x 900	<input type="checkbox"/>	<input type="checkbox"/>	LQ-OTT	<input type="checkbox"/>	OTT-HR	<input type="checkbox"/>	OTT-SL	<input type="checkbox"/>	OTT-FX
PHOENIX	1700 x 900	<input type="checkbox"/>		LQ-PHO	<input type="checkbox"/>	PHO-HR	<input type="checkbox"/>	PHO-SL	<input type="checkbox"/>	PHO-FX
TOKYO	1800 x 900	<input type="checkbox"/>	<input type="checkbox"/>	LQ-TOK	<input type="checkbox"/>	TOK-HR	<input type="checkbox"/>	TOK-SL	<input type="checkbox"/>	TOK-FX
OSLO	1900 x 900	<input type="checkbox"/>		LQ-OSL	<input type="checkbox"/>	OSL-HR	<input type="checkbox"/>	OSL-SL	<input type="checkbox"/>	OSL-FX
SINGAPORE	2000 x 900	<input type="checkbox"/>	<input type="checkbox"/>	LQ-SIN	<input type="checkbox"/>	SIN-HR	<input type="checkbox"/>	SIN-SL	<input type="checkbox"/>	SIN-FX

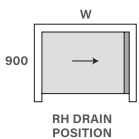
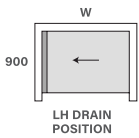

REQUIRED

ENTRY TYPE

Level Entry
Step Entry

*Find more info on
Pg. 86*

EXTRAS

**ARCHITECTURAL
FINISH**

*Fill in Order Form on
Pg. 103*

**FOUNDRY SERIES
HARDWARE
UPGRADE**

Brushed Nickel
Gunmetal
Brushed Gold
Matte Black
Polished Brass
Aged Brass

WALL LININGS

Ellure™ Tile Look
Walls

*Fill in Order Form on
Pg. 102*

EASYNICHE

*Fill in Order Form on
Pg. 105*

LINEA QUATTRO ORDER FORMS (2/3)

REQUIRED

ENTRY TYPE

- Level Entry
Step Entry

Find more info on
Pg. 86

EXTRAS

ARCHITECTURAL FINISH

Fill in Order Form on
Pg. 103

FOUNDRY SERIES HARDWARE UPGRADE

- Brushed Nickel
Gunmetal
Brushed Gold
Matte Black
Polished Brass
Aged Brass

WALL LININGS

Ellure™ Tile Look
Walls

Fill in Order Form on
Pg. 102

EASYNICHE

Fill in Order Form on
Pg. 105

3 WALL 1000 DEEP

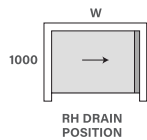
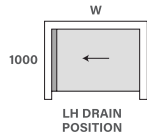
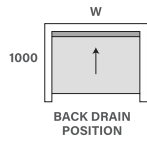

NAME
SIZE (mm)

LH DRAIN
RH DRAIN
BACK DRAIN

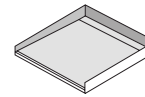

2160mm HIGH
FRAMELESS

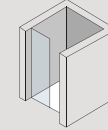
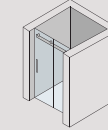
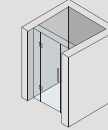

BASE & WASTE ONLY
NO SCREEN

BASE, WASTE &
HINGED DOOR HR

BASE, WASTE &
SLIDING DOOR SL

BASE, WASTE &
FIXED PANEL FX

	WIDTH	DEPTH				CODE				CODE				CODE
MADRID	1000 x 1000	<input type="checkbox"/>	<input type="checkbox"/>	<input type="checkbox"/>	LQ-MAD	<input type="checkbox"/>	MAD-HR	<input type="checkbox"/>	-	-	-	-	-	
GLASGOW	1100 x 1000	<input type="checkbox"/>			LQ-GLA	<input type="checkbox"/>	GLA-HR	<input type="checkbox"/>	GLA-SL	<input type="checkbox"/>	-	-	-	
TORONTO	1200 x 1000	<input type="checkbox"/>	<input type="checkbox"/>	<input type="checkbox"/>	LQ-TOR	<input type="checkbox"/>	TOR-HR	<input type="checkbox"/>	TOR-SL	<input type="checkbox"/>	TOR-FX	<input type="checkbox"/>		
EDINBURGH	1300 x 1000	<input type="checkbox"/>			LQ-EDI	<input type="checkbox"/>	EDI-HR	<input type="checkbox"/>	EDI-SL	<input type="checkbox"/>	EDI-FX	<input type="checkbox"/>		
LISBON	1400 x 1000	<input type="checkbox"/>	<input type="checkbox"/>	<input type="checkbox"/>	LQ-LIS	<input type="checkbox"/>	LIS-HR	<input type="checkbox"/>	LIS-SL	<input type="checkbox"/>	LIS-FX	<input type="checkbox"/>		
HELSINKI	1500 x 1000	<input type="checkbox"/>	<input type="checkbox"/>	<input type="checkbox"/>	LQ-HEL	<input type="checkbox"/>	HEL-HR	<input type="checkbox"/>	HEL-SL	<input type="checkbox"/>	HEL-FX	<input type="checkbox"/>		
CHICAGO	1600 x 1000	<input type="checkbox"/>	<input type="checkbox"/>	<input type="checkbox"/>	LQ-CHI	<input type="checkbox"/>	CHI-HR	<input type="checkbox"/>	CHI-SL	<input type="checkbox"/>	CHI-FX	<input type="checkbox"/>		
DUBAI	1700 x 1000	<input type="checkbox"/>			LQ-DUB	<input type="checkbox"/>	DUB-HR	<input type="checkbox"/>	DUB-SL	<input type="checkbox"/>	DUB-FX	<input type="checkbox"/>		
SEATTLE	1800 x 1000	<input type="checkbox"/>	<input type="checkbox"/>	<input type="checkbox"/>	LQ-SEA	<input type="checkbox"/>	SEA-HR	<input type="checkbox"/>	SEA-SL	<input type="checkbox"/>	SEA-FX	<input type="checkbox"/>		
HOUSTON	1900 x 1000	<input type="checkbox"/>			LQ-HOU	<input type="checkbox"/>	HOU-HR	<input type="checkbox"/>	HOU-SL	<input type="checkbox"/>	HOU-FX	<input type="checkbox"/>		
LONDON	2000 x 1000	<input type="checkbox"/>	<input type="checkbox"/>	<input type="checkbox"/>	LQ-LON	<input type="checkbox"/>	LON-HR	<input type="checkbox"/>	LON-SL	<input type="checkbox"/>	LON-FX	<input type="checkbox"/>		

3 WALL EXTRA DEEP 900 WIDE

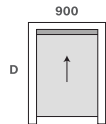

BACK DRAIN
POSITION

NAME
SIZE (mm)

BACK DRAIN

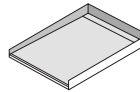

2160mm HIGH
FRAMELESS

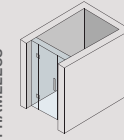

BASE & WASTE ONLY
NO SCREEN

BASE, WASTE &
HINGED DOOR HR

	WIDTH	DEPTH				CODE				CODE
AUSTIN	900 x 1200	<input type="checkbox"/>	LQ-AUS	<input type="checkbox"/>	AUS-HR	<input type="checkbox"/>				
LIMA	900 x 1400	<input type="checkbox"/>	LQ-LIM	<input type="checkbox"/>	LIM-HR	<input type="checkbox"/>				
TUSCANY	900 x 1600	<input type="checkbox"/>	LQ-TUS	<input type="checkbox"/>	TUS-HR	<input type="checkbox"/>				
MEMPHIS	900 x 1800	<input type="checkbox"/>	LQ-MEM	<input type="checkbox"/>	MEM-HR	<input type="checkbox"/>				

3½ WALL 1000 DEEP

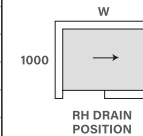
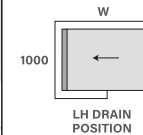

NAME
SIZE (mm)

LH DRAIN
RH DRAIN

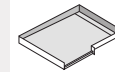

BASE & WASTE ONLY
NO SCREEN

	WIDTH	DEPTH				CODE
NAGOYA	1400 x 1000	<input type="checkbox"/>	<input type="checkbox"/>	LQ-NAG	<input type="checkbox"/>	
EDMONTON	1500 x 1000	<input type="checkbox"/>	<input type="checkbox"/>	LQ-EDM	<input type="checkbox"/>	
ORLANDO	1600 x 1000	<input type="checkbox"/>	<input type="checkbox"/>	LQ-ORL	<input type="checkbox"/>	
HONOLULU	1800 x 1000	<input type="checkbox"/>	<input type="checkbox"/>	LQ-HON	<input type="checkbox"/>	

NO SCREEN
WALK-IN ONLY

LINEA QUATTRO ORDER FORMS (3/3)

2 WALL
800 DEEP
900 DEEP
1000 DEEP

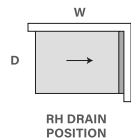
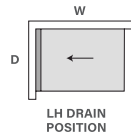

NAME
SIZE (mm)

LH DRAIN
RH DRAIN

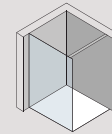
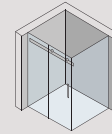
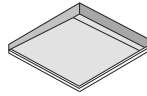

BASE & WASTE ONLY
NO SCREEN

BASE, WASTE &
HINGED DOOR HR

BASE, WASTE &
SLIDING DOOR SL

BASE, WASTE &
FIXED PANEL FX

	WIDTH	DEPTH	LH DRAIN		RH DRAIN		CODE	CODE	CODE	CODE
LIVERPOOL	1200 x 800		<input type="checkbox"/>	<input type="checkbox"/>	<input type="checkbox"/>	<input type="checkbox"/>	LQ-LIV	LIV-HR	LIV-SL	LIV-FX
OXFORD	1400 x 800		<input type="checkbox"/>	<input type="checkbox"/>	<input type="checkbox"/>	<input type="checkbox"/>	LQ-OXF	OXF-HR	OXF-SL	OXF-FX
DUBLIN	900 x 900		<input type="checkbox"/>	<input type="checkbox"/>	<input type="checkbox"/>	<input type="checkbox"/>	LQ-DUB	DUB-HR	-	-
BOSTON	1000 x 900		<input type="checkbox"/>	<input type="checkbox"/>	<input type="checkbox"/>	<input type="checkbox"/>	LQ-BOS	BOS-HR	-	-
RIO	1100 x 900		<input type="checkbox"/>	<input type="checkbox"/>	<input type="checkbox"/>	<input type="checkbox"/>	LQ-RIO	RIO-HR	RIO-SL	RIO-FX
MILAN	1200 x 900		<input type="checkbox"/>	<input type="checkbox"/>	<input type="checkbox"/>	<input type="checkbox"/>	LQ-MIL	MIL-HR	MIL-SL	MIL-FX
GENEVA	1300 x 900		<input type="checkbox"/>	<input type="checkbox"/>	<input type="checkbox"/>	<input type="checkbox"/>	LQ-GEN	GEN-HR	GEN-SL	GEN-FX
PARIS	1400 x 900		<input type="checkbox"/>	<input type="checkbox"/>	<input type="checkbox"/>	<input type="checkbox"/>	LQ-PAR	PAR-HR	PAR-SL	PAR-FX
SOFIA	1500 x 900		<input type="checkbox"/>	<input type="checkbox"/>	<input type="checkbox"/>	<input type="checkbox"/>	LQ-SOF	SOF-HR	SOF-SL	-
KANSAS	1600 x 900		<input type="checkbox"/>	<input type="checkbox"/>	<input type="checkbox"/>	<input type="checkbox"/>	LQ-KAN	KAN-HR	KAN-SL	-
TOLEDO	1800 x 900		<input type="checkbox"/>	<input type="checkbox"/>	<input type="checkbox"/>	<input type="checkbox"/>	LQ-TOL	TOL-HR	TOL-SL	-
MIAMI	1000 x 1000		<input type="checkbox"/>	<input type="checkbox"/>	<input type="checkbox"/>	<input type="checkbox"/>	LQ-MIA	MIA-HR	-	-
SHANGHAI	1200 x 1000		<input type="checkbox"/>	<input type="checkbox"/>	<input type="checkbox"/>	<input type="checkbox"/>	LQ-SHA	SHA-HR	SHA-SL	SHA-FX
VANCOUVER	1400 x 1000		<input type="checkbox"/>	<input type="checkbox"/>	<input type="checkbox"/>	<input type="checkbox"/>	LQ-VAN	VAN-HR	VAN-SL	VAN-FX
TAIPEI	1500 x 1000		<input type="checkbox"/>	<input type="checkbox"/>	<input type="checkbox"/>	<input type="checkbox"/>	LQ-TAI	TAI-HR	TAI-SL	-
CLEVELAND	1600 x 1000		<input type="checkbox"/>	<input type="checkbox"/>	<input type="checkbox"/>	<input type="checkbox"/>	LQ-CLE	CLE-HR	CLE-SL	-
RICHMOND	1800 x 1000		<input type="checkbox"/>	<input type="checkbox"/>	<input type="checkbox"/>	<input type="checkbox"/>	LQ-RIC	RIC-HR	RIC-SL	-

2 WALL ANGLE FRONT
1000 DEEP

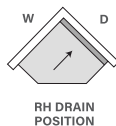
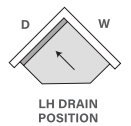

NAME
SIZE (mm)

LH DRAIN
RH DRAIN

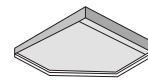

2160mm HIGH
FRAMELESS

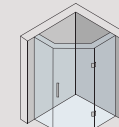

BASE & WASTE ONLY
NO SCREEN

BASE, WASTE &
HINGED DOOR HR

	WIDTH	DEPTH	LH DRAIN		RH DRAIN		CODE	CODE
ATHENS	1000 x 1000		<input type="checkbox"/>	<input type="checkbox"/>	<input type="checkbox"/>	<input type="checkbox"/>	LQ-ATH	ATH-HR

REQUIRED

ENTRY TYPE

Level Entry
Step Entry

*Find more info on
Pg. 86*

EXTRAS

ARCHITECTURAL
FINISH

*Fill in Order Form on
Pg. 103*

FOUNDRY SERIES
HARDWARE
UPGRADE

Brushed Nickel
Gunmetal
Brushed Gold
Matte Black
Polished Brass
Aged Brass

WALL LININGS

Ellure™ Tile Look
Walls

*Fill in Order Form on
Pg. 102*

EASYNICHE

*Fill in Order Form on
Pg. 105*

EASYTILE ORDER FORMS (1/1)

EXTRAS

FOUNDRY SERIES
HARDWARE
UPGRADE

Matte Black

WALL LININGS

Ellure™ Tile Look
Walls*

*Fill in Order Form on
Pg. 102

EASYNICHE

Fill in Order Form on
Pg. 105

3 WALL

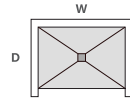

NAME
SIZE (mm)

CENTRE DRAIN

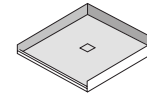

BASE & WASTE ONLY
NO SCREEN

1960mm HIGH
FRAMELESS

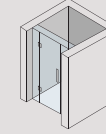

BASE, WASTE &
HINGED DOOR F

	WIDTH	DEPTH		CODE		CODE
COMMANDER	900 x 900		<input type="checkbox"/>	ET-COM	<input type="checkbox"/>	COM-ET-F <input type="checkbox"/>
AQUARIUS	1000 x 1000		<input type="checkbox"/>	ET-AQU	<input type="checkbox"/>	AQU-ET-F <input type="checkbox"/>
SYMPHONY	1200 x 900		<input type="checkbox"/>	ET-SYM	<input type="checkbox"/>	SYM-ET-F <input type="checkbox"/>
IMMERSION	1400 x 1000		<input type="checkbox"/>	ET-IMM	<input type="checkbox"/>	IMM-ET-F <input type="checkbox"/>

2 WALL

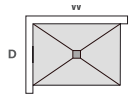

LH CONFIGURATION

NAME
SIZE (mm)

CENTRE DRAIN

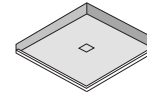

BASE & WASTE ONLY
NO SCREEN

1960mm HIGH
FRAMELESS

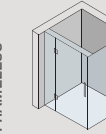

BASE, WASTE &
HINGED DOOR B

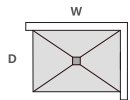

RH CONFIGURATION

	WIDTH	DEPTH		CODE		CODE
BOUTIQUE	900 x 900		<input type="checkbox"/>	ET-BOU	<input type="checkbox"/>	BOU-ET-B <input type="checkbox"/>
HARMONY	1000 x 1000		<input type="checkbox"/>	ET-HAR	<input type="checkbox"/>	HAR-ET-B <input type="checkbox"/>
SPLASH (LH)	1200 x 900		<input type="checkbox"/>	ET-SPL	<input type="checkbox"/>	SPL-ET-B <input type="checkbox"/>
ENCAPSULATOR (RH)	1200 x 900		<input type="checkbox"/>	ET-ENC	<input type="checkbox"/>	ENC-ET-B <input type="checkbox"/>
FABULOUS (LH)	1400 x 1000		<input type="checkbox"/>	ET-FAB	<input type="checkbox"/>	FAB-ET-B <input type="checkbox"/>
TRANQUILITY (RH)	1400 x 1000		<input type="checkbox"/>	ET-TRA	<input type="checkbox"/>	TRA-ET-B <input type="checkbox"/>

2 WALL ANGLE FRONT

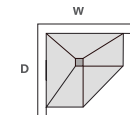

NAME
SIZE (mm)

CENTRE DRAIN

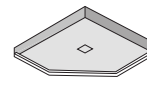

BASE & WASTE ONLY
NO SCREEN

1960mm HIGH
FRAMELESS

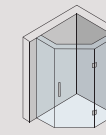

BASE, WASTE &
HINGED DOOR HA

	WIDTH	DEPTH		CODE		CODE
AMBIENCE	900 x 900		<input type="checkbox"/>	ET-AMB	<input type="checkbox"/>	AMB-ET-HA <input type="checkbox"/>
VIVIDO	1000 x 1000		<input type="checkbox"/>	ET-VIV	<input type="checkbox"/>	VIV-ET-H <input type="checkbox"/>

EBONY & IVORY ORDER FORMS (1/1)

3 WALL

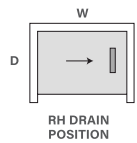
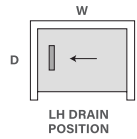

NAME	SIZE (mm)	LH DRAIN	RH DRAIN	2150mm HIGH FRAMELESS	BASE, WASTE & HINGED DOOR HR		BASE, WASTE & SLIDING DOOR SL		BASE, WASTE & WALK-IN FIXED PANEL FX	
					CODE		CODE		CODE	
MANILOW	1200 x 900	<input type="checkbox"/>	<input type="checkbox"/>	<input type="checkbox"/>	MAN-HR	<input type="checkbox"/>	MAN-SL	<input type="checkbox"/>	MAN-FX	<input type="checkbox"/>
HYMN	1200 x 1000	<input type="checkbox"/>	<input type="checkbox"/>	<input type="checkbox"/>	HYM-HR	<input type="checkbox"/>	HYM-SL	<input type="checkbox"/>	HYM-FX	<input type="checkbox"/>
RUMBA	1400 x 1000	<input type="checkbox"/>	<input type="checkbox"/>	<input type="checkbox"/>	RUM-HR	<input type="checkbox"/>	RUM-SL	<input type="checkbox"/>	RUM-FX	<input type="checkbox"/>

2 WALL

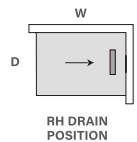
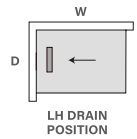

NAME	SIZE (mm)	LH DRAIN	RH DRAIN	2150mm HIGH FRAMELESS	BASE, WASTE & HINGED DOOR HR		BASE, WASTE & SLIDING DOOR SL		BASE, WASTE & WALK-IN FIXED PANEL FX	
					CODE		CODE		CODE	
MELODY	1000 x 1000	<input type="checkbox"/>	<input type="checkbox"/>	<input type="checkbox"/>	MEL-HR	<input type="checkbox"/>	-	-	-	-
LYRIC	1200 x 900	<input type="checkbox"/>	<input type="checkbox"/>	<input type="checkbox"/>	LYR-HR	<input type="checkbox"/>	LYR-SL	<input type="checkbox"/>	LYR-FX	<input type="checkbox"/>
TAMBORA	1200 x 1000	<input type="checkbox"/>	<input type="checkbox"/>	<input type="checkbox"/>	TAM-HR	<input type="checkbox"/>	TAM-SL	<input type="checkbox"/>	TAM-FX	<input type="checkbox"/>
RHYTHM	1400 x 1000	<input type="checkbox"/>	<input type="checkbox"/>	<input type="checkbox"/>	RHY-HR	<input type="checkbox"/>	RHY-SL	<input type="checkbox"/>	RHY-FX	<input type="checkbox"/>

REQUIRED

TRAY FINISH

Ivory White
Ebony Black

EXTRAS

FOUNDRY SERIES
HARDWARE
UPGRADE

Brushed Nickel
Gunmetal
Brushed Gold
Matte Black
Polished Brass
Aged Brass

WALL LININGS

Acrylic Wall Liner

Ellure™ Tile Look Walls*

* Fill in Order Form on Pg. 102

EASYNICHE

Fill in Order Form on Pg. 105

VERVE ORDER FORMS (1/1)

REQUIRED

TRAY FINISH

- Silk (White)
 Ash (Grey)
 Charcoal (Black)

EXTRAS

FOUNDRY SERIES HARDWARE UPGRADE

Matte Black

WALL LININGS

Acrylic Wall Liner

Ellure™ Tile Look
Walls*

*Fill in Order Form on
Pg. 102

EASYNICHE

Fill in Order Form on
Pg. 105

3 WALL

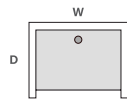

SIZE (mm)

CENTRE REAR DRAIN
2050mm HIGH
FRAMELESS

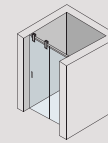
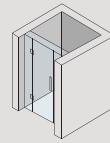

BASE, WASTE &
HINGED DOOR **HR**

BASE, WASTE &
SLIDING DOOR **SL**

WIDTH	DEPTH		CODE		CODE
900 x 900		•	VER135	<input type="checkbox"/>	VER146 <input type="checkbox"/>
1000 x 1000		•	VER131	<input type="checkbox"/>	VER145 <input type="checkbox"/>
1200 x 900		•	VER132	<input type="checkbox"/>	VER137 <input type="checkbox"/>
1500 x 1000		•	VER134	<input type="checkbox"/>	VER139 <input type="checkbox"/>

2 WALL

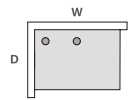

LH CONFIGURATION

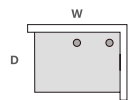

RH CONFIGURATION

SIZE (mm)

CENTRE REAR DRAIN
REAR DRAIN
2050mm HIGH
FRAMELESS

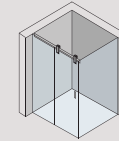
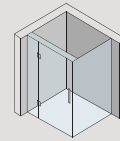

BASE, WASTE &
HINGED DOOR **HR**

BASE, WASTE &
SLIDING DOOR **SL**

WIDTH	DEPTH		CODE		CODE
900 x 900		•	VER111	<input type="checkbox"/>	VER144 <input type="checkbox"/>
1000 x 1000		•	VER112	<input type="checkbox"/>	VER143 <input type="checkbox"/>
1200 x 900 LH		•	VER113	<input type="checkbox"/>	VER123 <input type="checkbox"/>
1200 x 900 RH		•	VER118	<input type="checkbox"/>	VER128 <input type="checkbox"/>
1500 x 1000 LH		•	VER115	<input type="checkbox"/>	VER125 <input type="checkbox"/>
1500 x 1000 RH		•	VER120	<input type="checkbox"/>	VER130 <input type="checkbox"/>

2 WALL ANGLE FRONT

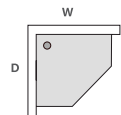

SIZE (mm)

REAR DRAIN
2050mm HIGH
FRAMELESS

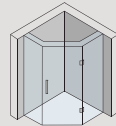

BASE, WASTE &
HINGED DOOR **HR**

WIDTH	DEPTH		CODE	
900 x 900		•	VER141	<input type="checkbox"/>
1000 x 1000		•	VER142	<input type="checkbox"/>

BLACK PEARL ORDER FORMS (1/1)

3 WALL

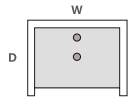

NAME
SIZE (mm)

CENTRE DRAIN
C/REAR DRAIN

2060mm HIGH
FRAMELESS

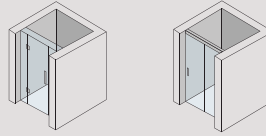

BASE, WASTE &
HINGED DOOR **F**

BASE, WASTE &
SLIDING DOOR **MG**

	WIDTH	DEPTH		CODE		CODE
MANIHIKI	900 x 750		<input type="checkbox"/>	MAN-RO-F	<input type="checkbox"/>	MAN-RO-MG
ARUBA	1200 x 750		<input type="checkbox"/>	ARU-RO-F	<input type="checkbox"/>	ARU-RO-MG
DELSOL	1500 x 750		<input type="checkbox"/>	DEL-RO-F	<input type="checkbox"/>	DEL-RO-MG
TRISTAN	900 x 900		<input type="checkbox"/>	TRI-RO/CO-F	<input type="checkbox"/>	TRI-RO/CO-MG
SEYCHELLES	1000 x 1000		<input type="checkbox"/>	SEY-RO/CO-F	<input type="checkbox"/>	SEY-RO/CO-MG
CAYMAN	1200 x 900		<input type="checkbox"/>	CAY-RO-F	<input type="checkbox"/>	CAY-RO-MG
PENRHYN	1500 x 900		<input type="checkbox"/>	PEN-RO-F	<input type="checkbox"/>	PEN-RO-MG
BERMUDA	1500 x 1000		<input type="checkbox"/>	BER-RO-F	<input type="checkbox"/>	BER-RO-MG
CALYPSO	1800 x 1000		<input type="checkbox"/>	CAL-CO-F	<input type="checkbox"/>	CAL-CO-MG

2 WALL ANGLE FRONT

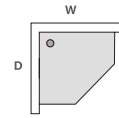

NAME
SIZE (mm)

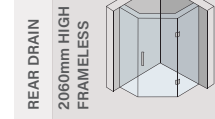

REAR DRAIN
2060mm HIGH
FRAMELESS

BASE, WASTE &
HINGED DOOR **HA**

	WIDTH	DEPTH		CODE
KOKOMO	900 x 900		<input type="checkbox"/>	KOK-RO-HA
LAGUNA	1000 x 1000		<input type="checkbox"/>	LAG-RO-HA

2 WALL

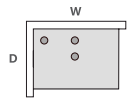

LH CONFIGURATION

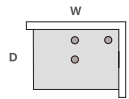

RH CONFIGURATION

NAME
SIZE (mm)

CENTRE DRAIN
REAR DRAIN
C/REAR DRAIN

2060mm HIGH
FRAMELESS

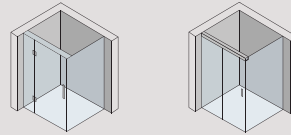

BASE, WASTE &
HINGED DOOR **B**

BASE, WASTE &
SLIDING DOOR **MG**

	WIDTH	DEPTH		CODE		CODE
PITCAIRN (LH)	900 x 750		<input type="checkbox"/>	PIT-RO-B	<input type="checkbox"/>	PIT-RO-MG
TROPICANA (RH)	900 x 750		<input type="checkbox"/>	TRO-RO-B	<input type="checkbox"/>	TRO-RO-MG
MONACO	900 x 900		<input type="checkbox"/>	MON-RO/CO-B	<input type="checkbox"/>	MON-RO/CO-MG
TAHITIAN (LH)	1000 x 900		<input type="checkbox"/>	TAH-RO-B	<input type="checkbox"/>	TAH-RO-MG
ZANZIBAR (RH)	1000 x 900		<input type="checkbox"/>	ZAN-RO-B	<input type="checkbox"/>	ZAN-RO-MG
MALIBU	1000 x 1000		<input type="checkbox"/>	MAL-RO/CO-B	<input type="checkbox"/>	MAL-RO/CO-MG
GRENADA (LH)	1200 x 750		<input type="checkbox"/>	GRE-RO-B	<input type="checkbox"/>	GRE-RO-MG
ACAPULCO (RH)	1200 x 750		<input type="checkbox"/>	ACA-RO-B	<input type="checkbox"/>	ACA-RO-MG
BAHAMAS (LH)	1200 x 900		<input type="checkbox"/>	BAH-RO/CO-B	<input type="checkbox"/>	BAH-RO/CO-MG
MAURITIUS (RH)	1200 x 900		<input type="checkbox"/>	MAU-RO/CO-B	<input type="checkbox"/>	MAU-RO/CO-MG
TOBAGO (LH)	1500 x 750		<input type="checkbox"/>	TOB-CR-B	<input type="checkbox"/>	TOB-CR-MG
BARBADOS (RH)	1500 x 750		<input type="checkbox"/>	BAR-CR-B	<input type="checkbox"/>	BAR-CR-MG
ANTIGUA (LH)	1500 x 900		<input type="checkbox"/>	ANT-CR-B	<input type="checkbox"/>	ANT-CR-MG
MARBELLA (RH)	1500 x 900		<input type="checkbox"/>	MAR-CR-B	<input type="checkbox"/>	MAR-CR-MG
FLORIDA (LH)	1500 x 1000		<input type="checkbox"/>	FLO-CR-B	<input type="checkbox"/>	FLO-CR-MG
NAUTILUS (RH)	1500 x 1000		<input type="checkbox"/>	NAU-CR-B	<input type="checkbox"/>	NAU-CR-MG

EXTRAS

FOUNDRY SERIES
HARDWARE
UPGRADE

Matte Black

WALL LININGS

Acrylic Wall Liner

Ellure™ Tile Look
Walls*

*Fill in Order Form on
Pg. 102

EASYNICHE

Fill in Order Form on
Pg. 105

QUUB ORDER FORMS (1/1)

EXTRAS

FOUNDRY SERIES HARDWARE UPGRADE

Matte Black

*Note: Matte Black
Hardware Upgrade
included in Graphite
System pricing*

WALL LININGS

Acrylic Wall Liner

Ellure™ Tile Look
Walls*

**Fill in Order Form on
Pg. 102*

EASYNICHE

*Fill in Order Form on
Pg. 105*

3 WALL

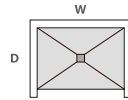

NAME
SIZE (mm)

		PURE WHITE		GRAPHITE	
		BASE & WASTE ONLY NO SCREEN	BASE, WASTE & HINGED DOOR F	BASE & WASTE ONLY NO SCREEN	BASE, WASTE & HINGED DOOR F
		WIDTH	DEPTH	CODE	CODE
CHARISMA	900 x 900	QU-CHA	<input type="checkbox"/>	CHA-QU-F	<input type="checkbox"/>
LEISURE	1000 x 1000	QU-LEI	<input type="checkbox"/>	LEI-QU-F	<input type="checkbox"/>
GALAXY	1200 x 900	QU-GAL	<input type="checkbox"/>	GAL-QU-F	<input type="checkbox"/>
MUSE	1400 x 1000	QU-MUS	<input type="checkbox"/>	MUS-QU-F	<input type="checkbox"/>

2 WALL

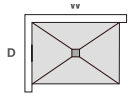

LH CONFIGURATION

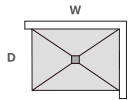

RH CONFIGURATION

NAME
SIZE (mm)

		PURE WHITE		GRAPHITE	
		BASE & WASTE ONLY NO SCREEN	BASE, WASTE & HINGED DOOR B	BASE & WASTE ONLY NO SCREEN	BASE, WASTE & HINGED DOOR B
		WIDTH	DEPTH	CODE	CODE
PARADIGM	900 x 900	QU-PAR	<input type="checkbox"/>	PAR-QU-B	<input type="checkbox"/>
IDYLLIC	1000 x 1000	QU-IDY	<input type="checkbox"/>	IDY-QU-B	<input type="checkbox"/>
BRAVO (LH)	1200 x 900	QU-BRA	<input type="checkbox"/>	BRA-QU-B	<input type="checkbox"/>
NIRVANA (RH)	1200 x 900	QU-NIR	<input type="checkbox"/>	NIR-QU-B	<input type="checkbox"/>
MAJESTIC (LH)	1400 x 1000	QU-MAJ	<input type="checkbox"/>	MAJ-QU-B	<input type="checkbox"/>
UTOPIA (RH)	1400 x 1000	QU-UTO	<input type="checkbox"/>	UTO-QU-B	<input type="checkbox"/>

2 WALL ANGLE FRONT

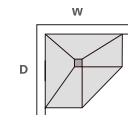

NAME
SIZE (mm)

		PURE WHITE		GRAPHITE	
		BASE & WASTE ONLY NO SCREEN	BASE, WASTE & HINGED DOOR HA	BASE & WASTE ONLY NO SCREEN	BASE, WASTE & HINGED DOOR HA
		WIDTH	DEPTH	CODE	CODE
DULCET	900 x 900	QU-DUL	<input type="checkbox"/>	DUL-QU-HA	<input type="checkbox"/>
MANTRA	1000 x 1000	QU-MAN	<input type="checkbox"/>	MAN-QU-H	<input type="checkbox"/>

FRAMELESS SCREENS ORDER FORMS (1/2)

3 WALL

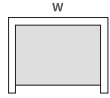

SIZE (mm)

2120mm HIGH
FRAMELESS

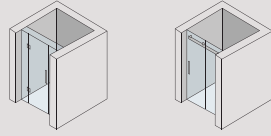

HINGED DOOR **HR**

SLIDING DOOR **SL**

WIDTH	CODE		CODE	
900	AFS-3W-9	<input type="checkbox"/>		
1000	AFS-3W-10	<input type="checkbox"/>		
1100	AFS-3W-11	<input type="checkbox"/>	AFS-3W-SL-11	<input type="checkbox"/>
1200	AFS-3W-12	<input type="checkbox"/>	AFS-3W-SL-12	<input type="checkbox"/>
1300	AFS-3W-13	<input type="checkbox"/>	AFS-3W-SL-13	<input type="checkbox"/>
1400	AFS-3W-14	<input type="checkbox"/>	AFS-3W-SL-14	<input type="checkbox"/>
1500	AFS-3W-15	<input type="checkbox"/>	AFS-3W-SL-15	<input type="checkbox"/>
1600	AFS-3W-16	<input type="checkbox"/>	AFS-3W-SL-16	<input type="checkbox"/>
1700	AFS-3W-17	<input type="checkbox"/>	AFS-3W-SL-17	<input type="checkbox"/>
1800	AFS-3W-18	<input type="checkbox"/>	AFS-3W-SL-18	<input type="checkbox"/>
1900	AFS-3W-19	<input type="checkbox"/>	AFS-3W-SL-19	<input type="checkbox"/>
2000	AFS-3W-20	<input type="checkbox"/>	AFS-3W-SL-20	<input type="checkbox"/>

2 WALL ANGLE FRONT

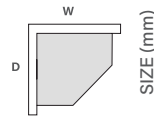

SIZE (mm)

2120mm HIGH
FRAMELESS

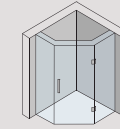

HINGED DOOR **HR**

WIDTH	DEPTH	CODE	
900 x 900		AFS-2W-9X9AF	<input type="checkbox"/>
1000 x 1000		AFS-2W-10X10AF	<input type="checkbox"/>

FIXED PANEL 2 WALL OR 3 WALL

SIZE (mm)

2120mm HIGH
FRAMELESS

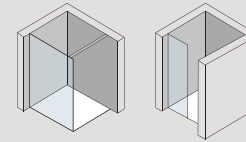

FIXED PANEL **FX**

WIDTH	CODE	
570	AFS-FX-570	<input type="checkbox"/>
670	AFS-FX-670	<input type="checkbox"/>
870	AFS-FX-870	<input type="checkbox"/>
970	AFS-FX-970	<input type="checkbox"/>
1070	AFS-FX-1070	<input type="checkbox"/>
1170	AFS-FX-1170	<input type="checkbox"/>
1270	AFS-FX-1270	<input type="checkbox"/>
1370	AFS-FX-1370	<input type="checkbox"/>

EXTRAS

FOUNDRY SERIES HARDWARE UPGRADE

- Brushed Nickel
- Gunmetal
- Brushed Gold
- Matte Black
- Polished Brass
- Aged Brass

FRAMELESS SCREENS ORDER FORMS (2/2)

EXTRAS

FOUNDRY SERIES
HARDWARE
UPGRADE

- Brushed Nickel
- Gunmetal
- Brushed Gold
- Matte Black
- Polished Brass
- Aged Brass

2 WALL 800 DEEP 900 DEEP

SIZE (mm)

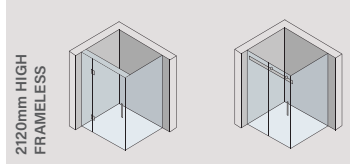

BASE, WASTE & HINGED DOOR **HR**

BASE, WASTE & SLIDING DOOR **SL**

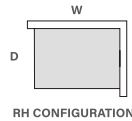
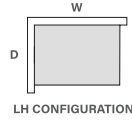

WIDTH	DEPTH	CODE		CODE	
900 x 800		AFS-2W-9X8	<input type="checkbox"/>	-	-
1000 x 800		AFS-2W-10X8	<input type="checkbox"/>	-	-
1100 x 800		AFS-2W-11X8	<input type="checkbox"/>	AFS-2W-SL-11X8	<input type="checkbox"/>
1200 x 800		AFS-2W-12X8	<input type="checkbox"/>	AFS-2W-SL-12X8	<input type="checkbox"/>
1300 x 800		AFS-2W-13X8	<input type="checkbox"/>	AFS-2W-SL-13X8	<input type="checkbox"/>
1400 x 800		AFS-2W-14X8	<input type="checkbox"/>	AFS-2W-SL-14X8	<input type="checkbox"/>
1500 x 800		-	-	AFS-2W-SL-15X8	<input type="checkbox"/>
1600 x 800		-	-	AFS-2W-SL-16X8	<input type="checkbox"/>
1700 x 800		-	-	AFS-2W-SL-17X8	<input type="checkbox"/>
1800 x 800		-	-	AFS-2W-SL-18X8	<input type="checkbox"/>
1900 x 800		-	-	AFS-2W-SL-19X8	<input type="checkbox"/>
2000 x 800		-	-	AFS-2W-SL-20X8	<input type="checkbox"/>
900 x 900		AFS-2W-9X9	<input type="checkbox"/>	-	-
1000 x 900		AFS-2W-10X9	<input type="checkbox"/>	-	-
1100 x 900		AFS-2W-11X9	<input type="checkbox"/>	AFS-2W-SL-11X9	<input type="checkbox"/>
1200 x 900		AFS-2W-12X9	<input type="checkbox"/>	AFS-2W-SL-12X9	<input type="checkbox"/>
1300 x 900		AFS-2W-13X9	<input type="checkbox"/>	AFS-2W-SL-13X9	<input type="checkbox"/>
1400 x 900		AFS-2W-14X9	<input type="checkbox"/>	AFS-2W-SL-14X9	<input type="checkbox"/>
1500 x 900		-	-	AFS-2W-SL-15X9	<input type="checkbox"/>
1600 x 900		-	-	AFS-2W-SL-16X9	<input type="checkbox"/>
1700 x 900		-	-	AFS-2W-SL-17X9	<input type="checkbox"/>
1800 x 900		-	-	AFS-2W-SL-18X9	<input type="checkbox"/>
1900 x 900		-	-	AFS-2W-SL-19X9	<input type="checkbox"/>
2000 x 900		-	-	AFS-2W-SL-20X9	<input type="checkbox"/>

2 WALL 1000 DEEP 1100 DEEP 1200 DEEP 1300 DEEP 1400 DEEP

SIZE (mm)

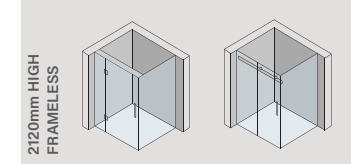

BASE, WASTE & HINGED DOOR **HR**

BASE, WASTE & SLIDING DOOR **SL**

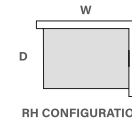
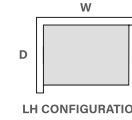

WIDTH	DEPTH	CODE		CODE	
900 x 1000		AFS-2W-9X1	<input type="checkbox"/>	-	-
1000 x 1000		AFS-2W-10X1	<input type="checkbox"/>	-	-
1100 x 1000		AFS-2W-11X1	<input type="checkbox"/>	AFS-2W-SL-11X1	<input type="checkbox"/>
1200 x 1000		AFS-2W-12X1	<input type="checkbox"/>	AFS-2W-SL-12X1	<input type="checkbox"/>
1300 x 1000		AFS-2W-13X1	<input type="checkbox"/>	AFS-2W-SL-13X1	<input type="checkbox"/>
1400 x 1000		AFS-2W-14X1	<input type="checkbox"/>	AFS-2W-SL-14X1	<input type="checkbox"/>
1500 x 1000		-	-	AFS-2W-SL-15X1	<input type="checkbox"/>
1600 x 1000		-	-	AFS-2W-SL-16X1	<input type="checkbox"/>
1700 x 1000		-	-	AFS-2W-SL-17X1	<input type="checkbox"/>
1800 x 1000		-	-	AFS-2W-SL-18X1	<input type="checkbox"/>
1900 x 1000		-	-	AFS-2W-SL-19X1	<input type="checkbox"/>
2000 x 1000		-	-	AFS-2W-SL-20X1	<input type="checkbox"/>
1100 x 1100		AFS-2W-11X11	<input type="checkbox"/>	-	-
1200 x 1100		AFS-2W-12X11	<input type="checkbox"/>	-	-
1300 x 1100		AFS-2W-13X11	<input type="checkbox"/>	-	-
1400 x 1100		AFS-2W-14X11	<input type="checkbox"/>	-	-
1200 x 1200		AFS-2W-12X12	<input type="checkbox"/>	AFS-2W-SL-12X12	<input type="checkbox"/>
1300 x 1200		AFS-2W-13X12	<input type="checkbox"/>	AFS-2W-SL-13X12	<input type="checkbox"/>
1400 x 1200		AFS-2W-14X12	<input type="checkbox"/>	AFS-2W-SL-14X12	<input type="checkbox"/>
1500 x 1200		-	-	AFS-2W-SL-15X12	<input type="checkbox"/>
1600 x 1200		-	-	AFS-2W-SL-16X12	<input type="checkbox"/>
1700 x 1200		-	-	AFS-2W-SL-17X12	<input type="checkbox"/>
1800 x 1200		-	-	AFS-2W-SL-18X12	<input type="checkbox"/>
1900 x 1200		-	-	AFS-2W-SL-19X12	<input type="checkbox"/>
2000 x 1200		-	-	AFS-2W-SL-20X12	<input type="checkbox"/>
1300 x 1300		AFS-2W-13X13	<input type="checkbox"/>	-	-
1400 x 1300		AFS-2W-14X13	<input type="checkbox"/>	-	-
1400 x 1400		AFS-2W-14X14	<input type="checkbox"/>	-	-

ELLURE TILE LOOK WALLS ORDER FORMS (1/1)

2 WALL &
ANGLE
FRONT
SHOWERS

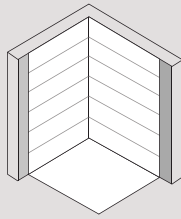

SMALL
UP TO 1200mm WIDE

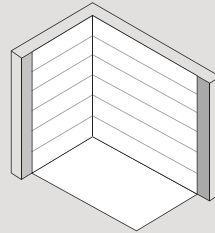

MEDIUM
1201-1600mm WIDE

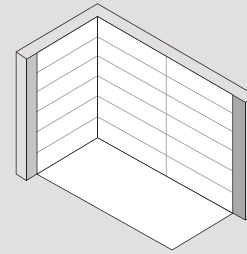

LARGE
*OVER 1601mm WIDE

SINGLE SHEETS

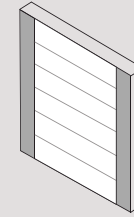

2400mm x 1200mm

SIMPLY WHITE - GLOSS

CODE
ELL-WPP-2

SIMPLY WHITE - SILK

SILK-WPP-2

SUBWAY - GLOSS

ELL-WPP-14

SUBWAY - SILK

SILK-WPP-14

CODE
ELL-WPP-4

SILK-WPP-4

ELL-WPP-16

SILK-WPP-16

CODE
ELL-WPP-28

SILK-WPP-28

ELL-WPP-18

SILK-WPP-18

CODE
ELL-WPP-13

SILK-WPP-13

ELL-WPP-26

SILK-WPP-26

3 WALL
SHOWERS

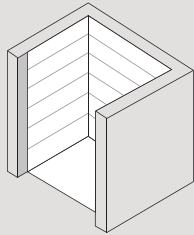

SMALL
UP TO 1200mm WIDE

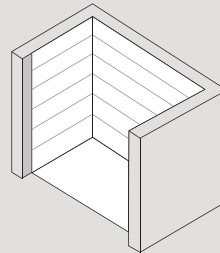

MEDIUM
1201-1600mm WIDE

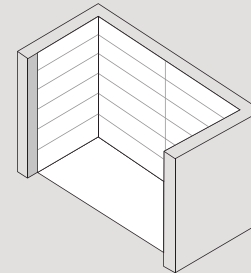

LARGE
*OVER 1601mm WIDE

SIMPLY WHITE - GLOSS

CODE
ELL-WPP-7

SIMPLY WHITE - SILK

SILK-WPP-7

SUBWAY - GLOSS

ELL-WPP-20

SUBWAY - SILK

SILK-WPP-20

CODE
ELL-WPP-10

SILK-WPP-10

ELL-WPP-22

SILK-WPP-22

CODE
ELL-WPP-12

SILK-WPP-12

ELL-WPP-24

SILK-WPP-24

*SHOWERS OVER 1601mm WIDE INCLUDE A DISCREET JOINTER IN MIDDLE OF LONG WALL

ARCHITECTURAL FINISH ORDER FORMS (1/1)



WHITE
LIBERETTOSTONE™

CODE

UP TO 1200mm WIDE

AF-MW-SMALL

OVER 1200mm WIDE

AF-MW-LARGE



CALACUTTA GOLD
LIBERETTOSTONE™

CODE

AF-CG-SMALL

AF-CG-LARGE



ALABASTER
PORCELAIN SLAB

CODE

AF-ALA-SMALL

AF-ALA-LARGE



SUNSTONE
LIBERETTOSTONE™

CODE

UP TO 1200mm WIDE

AF-SU-SMALL

OVER 1200mm WIDE

AF-SU-LARGE



URBAN CONCRETE
LIBERETTOSTONE™

CODE

AF-UC-SMALL

AF-UC-LARGE

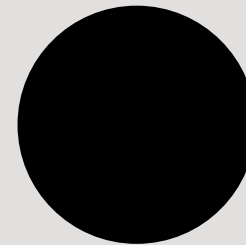

BLACK
LIBERETTOSTONE™

CODE

AF-MB-SMALL

AF-MB-LARGE

FOUNDRY SERIES ORDER FORMS (1/1)

BRUSHED NICKEL <i>PVD</i>				GUNMETAL <i>PVD</i>				BRUSHED GOLD <i>PVD</i>			
RANGE	SCREEN TYPE	CODE	<input type="checkbox"/>	RANGE	SCREEN TYPE	CODE	<input type="checkbox"/>	RANGE	SCREEN TYPE	CODE	<input type="checkbox"/>
LINEA QUATTRO	SLIDING, HINGED	8048BN	<input type="checkbox"/>	LINEA QUATTRO	SLIDING, HINGED	8048GM	<input type="checkbox"/>	LINEA QUATTRO	SLIDING, HINGED	8048BG	<input type="checkbox"/>
	FIXED PANEL, BASE ONLY	7048BN	<input type="checkbox"/>		FIXED PANEL, BASE ONLY	7048GM	<input type="checkbox"/>		FIXED PANEL, BASE ONLY	7048BG	<input type="checkbox"/>
EBONY & IVORY	SLIDING, HINGED	4048BN	<input type="checkbox"/>	EBONY & IVORY	SLIDING, HINGED	4048GM	<input type="checkbox"/>	EBONY & IVORY	SLIDING, HINGED	4048BG	<input type="checkbox"/>
	FIXED PANEL	3048BN	<input type="checkbox"/>		FIXED PANEL	3048GM	<input type="checkbox"/>		FIXED PANEL	3048BG	<input type="checkbox"/>
NAKED FRAMELESS	SLIDING, HINGED	4048BN	<input type="checkbox"/>	NAKED FRAMELESS	SLIDING, HINGED	4048GM	<input type="checkbox"/>	NAKED FRAMELESS	SLIDING, HINGED	4048BG	<input type="checkbox"/>
	FIXED PANEL	3048BN	<input type="checkbox"/>		FIXED PANEL	3048GM	<input type="checkbox"/>		FIXED PANEL	3048BG	<input type="checkbox"/>
ACCESSIBLE SHOWER	SLIDING, HINGED	4048BN	<input type="checkbox"/>	ACCESSIBLE SHOWER	SLIDING, HINGED	4048GM	<input type="checkbox"/>	ACCESSIBLE SHOWER	SLIDING, HINGED	4048BG	<input type="checkbox"/>
	FIXED PANEL, BASE ONLY	3048BN	<input type="checkbox"/>		FIXED PANEL, BASE ONLY	3048GM	<input type="checkbox"/>		FIXED PANEL, BASE ONLY	3048BG	<input type="checkbox"/>
VERVE	SLIDING, HINGED	4048BN	<input type="checkbox"/>	VERVE	SLIDING, HINGED	4048GM	<input type="checkbox"/>	VERVE	SLIDING, HINGED	4048BG	<input type="checkbox"/>
	FIXED PANEL	3048BN	<input type="checkbox"/>		FIXED PANEL	3048GM	<input type="checkbox"/>		FIXED PANEL	3048BG	<input type="checkbox"/>

MATTE BLACK <i>EP</i>				POLISHED BRASS* <i>LF</i>				AGED BRASS* <i>LF</i>			
RANGE	SCREEN TYPE	CODE	<input type="checkbox"/>	RANGE	SCREEN TYPE	CODE	<input type="checkbox"/>	RANGE	SCREEN TYPE	CODE	<input type="checkbox"/>
LINEA QUATTRO	SLIDING, HINGED	8048MB	<input type="checkbox"/>	LINEA QUATTRO	SLIDING, HINGED	8048PB	<input type="checkbox"/>	LINEA QUATTRO	SLIDING, HINGED	8048AB	<input type="checkbox"/>
	FIXED PANEL, BASE ONLY	7048MB	<input type="checkbox"/>		FIXED PANEL, BASE ONLY	7048PB	<input type="checkbox"/>		FIXED PANEL, BASE ONLY	7048AB	<input type="checkbox"/>
EBONY & IVORY	SLIDING, HINGED	4048MB	<input type="checkbox"/>	EBONY & IVORY	SLIDING, HINGED	4048PB	<input type="checkbox"/>	EBONY & IVORY	SLIDING, HINGED	4048AB	<input type="checkbox"/>
	FIXED PANEL, BASE ONLY	3048MB	<input type="checkbox"/>		FIXED PANEL, BASE ONLY	3048PB	<input type="checkbox"/>		FIXED PANEL, BASE ONLY	3048AB	<input type="checkbox"/>
NAKED FRAMELESS	SLIDING, HINGED	4048MB	<input type="checkbox"/>	NAKED FRAMELESS	SLIDING, HINGED	4048PB	<input type="checkbox"/>	NAKED FRAMELESS	SLIDING, HINGED	4048AB	<input type="checkbox"/>
	FIXED PANEL	3048MB	<input type="checkbox"/>		FIXED PANEL	3048PB	<input type="checkbox"/>		FIXED PANEL	3048AB	<input type="checkbox"/>
ACCESSIBLE SHOWER	SLIDING, HINGED	4048MB	<input type="checkbox"/>	ACCESSIBLE SHOWER	SLIDING, HINGED	4048PB	<input type="checkbox"/>	ACCESSIBLE SHOWER	SLIDING, HINGED	4048AB	<input type="checkbox"/>
	FIXED PANEL, BASE ONLY	3048MB	<input type="checkbox"/>		FIXED PANEL, BASE ONLY	3048PB	<input type="checkbox"/>		FIXED PANEL, BASE ONLY	3048AB	<input type="checkbox"/>
VERVE	SLIDING, HINGED	4048MB	<input type="checkbox"/>	VERVE	SLIDING, HINGED	4048PB	<input type="checkbox"/>	VERVE	SLIDING, HINGED	4048AB	<input type="checkbox"/>
	FIXED PANEL	3048MB	<input type="checkbox"/>		FIXED PANEL	3048PB	<input type="checkbox"/>		FIXED PANEL	3048AB	<input type="checkbox"/>
BLACK PEARL	SLIDING, HINGED	4048MB	<input type="checkbox"/>	BLACK PEARL	HINGED	4048PB	<input type="checkbox"/>	BLACK PEARL	HINGED	4048AB	<input type="checkbox"/>
EASYTILE	HINGED	8048MB	<input type="checkbox"/>	EASYTILE	HINGED	8048PB	<input type="checkbox"/>	EASYTILE	HINGED	8048AB	<input type="checkbox"/>
	BASE ONLY	7048MB	<input type="checkbox"/>		BASE ONLY	7048PB	<input type="checkbox"/>		BASE ONLY	7048AB	<input type="checkbox"/>
QUUB	HINGED	8048MB	<input type="checkbox"/>	QUUB	HINGED	8048PB	<input type="checkbox"/>	QUUB	HINGED	8048AB	<input type="checkbox"/>
	BASE ONLY	7048MB	<input type="checkbox"/>		BASE ONLY	7048PB	<input type="checkbox"/>		BASE ONLY	7048AB	<input type="checkbox"/>

*Brass finishes supplied with Matte Black Glazing Channels and Sliding Top Brace.

PVD – PHYSICAL VAPOUR DISPOSITION **EP** – ELECTROPLATED **LF** – LIVING FINISH

Visit atlantis.co.nz for more information on Foundry Series.

EASYNICHE ORDER FORMS (1/1)

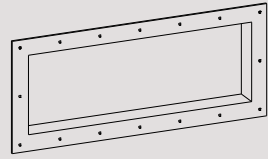

TILE-OVER SHELF

SIZE	CODE	
1540 x 340	EN1500	<input type="checkbox"/>
1240 x 340	EN1200	<input type="checkbox"/>
940 x 340	EN900	<input type="checkbox"/>
790 x 340	EN750	<input type="checkbox"/>
640 x 340	EN600	<input type="checkbox"/>
540 x 340	EN500	<input type="checkbox"/>
490 x 340	EN450	<input type="checkbox"/>
390 x 340	EN350	<input type="checkbox"/>
340 x 340	EN300	<input type="checkbox"/>
240 x 340	EN200	<input type="checkbox"/>

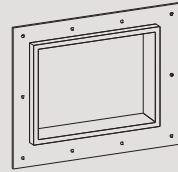

'EXPOSED' SHELF

SIZE	FINISH	CODE	
400 x 300	GLOSS WHITE	EN400EX12-W	<input type="checkbox"/>

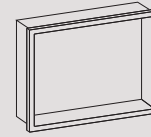

'RETROFIT' SHELF

SIZE	FINISH	CODE	
400 x 300	GLOSS WHITE	EN400RF-W	<input type="checkbox"/>
400 x 300	MATTE WHITE	EN400RF-SILK	<input type="checkbox"/>
400 x 300	GLOSS BLACK	EN400RF-B	<input type="checkbox"/>



'RETROFIT' FOOTREST

SIZE	FINISH	CODE	
220 x 160	GLOSS WHITE	EN140RF-W	<input type="checkbox"/>
220 x 160	MATTE WHITE	EN400RF-SILK	<input type="checkbox"/>
220 x 160	GLOSS BLACK	EN140RF-B	<input type="checkbox"/>



TILE-OVER FOOTREST

SIZE	CODE	
180 x 120	EN140F	<input type="checkbox"/>



RECESSED TOWEL WARMER

FINISH	SIZE	CODE	
WHITE RECESS CHROME RAILS	600 x 1200	ENTW-RF612-W	<input type="checkbox"/>
WHITE RECESS BLACK RAILS	600 x 1200	ENTW-RF612-W-B	<input type="checkbox"/>
BLACK RECESS BLACK RAILS	600 x 1200	ENTW-RF612-B-B	<input type="checkbox"/>



OUR STORY

It's a combination of talents that starts with Atlantis Founder, Bruce Warner. His striking design vision and rare engineering abilities, are the basis of our reputation and our achievement.

What does refined design mean? It means paring away every inessential detail. It means bringing out the most sophisticated, most elegant lines and forms. And it means designing with years of use in mind.

Engineering and technology? Well, we've never been satisfied with the usual. We like taking things apart, rethinking them, exploring new possibilities, developing new standards of efficiency, making things more robust, better suited to purpose. In short, we like inventing things that work better than all other comparisons.

We've put both strands of thinking into every Atlantis product.

Important too, we have never hurried things to market. We've taken our time to perfect every feature. Atlantis all-in-one tile-over shower systems underwent a full four years of development prior to release. They have now been manufactured for over twenty-five years, and are enjoyed throughout Australasia.

**'Beautiful to look at. Fabulous to live with.
Astonishingly easy to install. Leak-free for life.'**

Visit atlantis.co.nz to discover more about Atlantis and why we are so passionate about what we do.

