



Programme of Delivery

Pool + Spa

2024

Pool edge systems

The appropriate pool edge systems for all types of pools (competition pools, leisure and adventure pools etc.). Information on the pages 16 - 77.



Around the pool

Products for underwater areas and pool surrounds in a great variety of formats and surfaces. Information on the pages 118 - 217.



Designing with mosaics

Small formats for individual designs – in an enormous diversity of colors and designs. Information on the pages 218 - 247.

Pool + Spa

Introduction	4 – 15
Hytect	8 – 9
Product finder	10 – 15
Pool edge systems	16 – 87
Overview	18 – 21
Finland	22 – 27
Finland II	28 – 33
Wiesbaden, elevated water level	34 – 37
Wiesbaden Silent	38 – 39
Wiesbaden with mosaic recess	40 – 41
Wiesbaden Stil	42 – 45
Wiesbaden, decreased water level	46 – 49
Wiesbaden, therapy pools	50 – 53
Bamberg	54 – 57
St. Moritz	58 – 61
Berlin	62 – 65
Zürich	66 – 69
Skimmer	70 – 73
NEW AGROB BUCHTAL CarboCeram	74 – 77
Swimming pool accessories	78 – 87
Ceramic channel cover 2.0	80 – 83
Cover gratings	84 – 85
Outlets	86 – 87

Swimming pool special pieces	88 – 117
Pool edging tiles	90 – 93
Skirtings, Profiled edgings	94 – 101
Grooved tiles	102 – 107
Special tiles	108 – 117
Around the pool	118 – 217
Introduction	120 – 121
Overview – Pool surrounds	122 – 127
Ascona	128 – 141
Chroma	142 – 151
Chroma non-slip	152 – 161
Chroma unglazed	162 – 169
Plural	170 – 189
Plural non-slip	190 – 197
Plural unglazed	198 – 203
Quarzit	204 – 211
Savona	212 – 217
Designing with mosaics	218 – 247
Introduction	220 – 221
Mosaic Designer	222 – 223
Fresh	224 – 237
Loop	238 – 246
Planning and know-how	248 – 259
In-house planning department	250 – 251
Slip-resistance	252 – 253
Competition pools	254 – 255
Accessibility	256 – 257
Cleaning instructions	258 – 259

Index/Technical Information

Article numbers	262 – 271
Models	272
Model numbers	273
Classification according to NCS/RAL Lightness values	274 – 275
Luminance contrast	276 – 277
Technical Information	278 – 297
World-wide distribution network	298 – 299
Comments	302 – 303

Pool + Pool surround

Perfect design and functionality.



Sports and competition pools

Duna Aréna, Budapest, Hungary

Architect: NAPUR Architect Kft / Series: Plural / Photo: Péter Molnár



Open air swimming pools

Aquapark Cikat, Mali Losinji, Croatia

Architect: Urbing d.o.o. / Series: Chroma / Photo: Michael Meschede



Leisure/adventure pools

Havel-Therme, Werder (Havel), Germany

Architect: Geising & Böker GmbH Architekten BDA

Series: Savona, Plural / Photo: Jochen Stüber



School/learners' pools

City of London Freeman's School, London, Great Britain

Architect: Hawkins Brown Architects LLP

Series: Chroma, pool edge system Finland / Photo: Jack Hobhouse photography



Thermal/therapeutic baths

Chiemgau Thermen, Bad Endorf, Germany
 Architect: Architekturwerkstatt Zopf
 Series: Quarzit / Photo: Peters Fotodesign, Amerang

Hotel pools

Hotel aja, Garmisch-Patenkirchen, Germany
 Architect: SMAP SEEGER MÜLLER Berlin und Büro Korb, Hamburg
 Series: Quarzit, Savona / Photo: Fotodesign Peters, Amerang



Private pools

Villa an der Costa Blanca, Denia, Spain
 Series: Quarzit / Photo: Marcella Grassi, Barcelona

Convincing arguments in favour of swimming pool ceramics from AGROB BUCHTAL

- Decades of experience with swimming pool ceramics for highest demands
- Advice regarding application techniques and relief of routine tasks by AGROB BUCHTAL's in-house planning department
- Hytect technology for easy cleaning, antibacterial effect and elimination of air pollutants
- Accident prevention thanks to graded slip resistance with the GRIP quality seal, absolutely easy to clean
- Greatest design freedom possible thanks to an enormous variety of colors and formats and the possibility of individual special productions
- Special pool edge systems for the most diverse types of use
- Perfectly matched accessories for solutions from one single source
- Cost-effective solutions for all types and sizes of swimming pools
- Maximum resistance of ceramics also in case of saline and sulphate thermal waters

Showers + Changing rooms

Freedom in color, decoration and format



The design of a swimming pool does not end at the pool edge. The aesthetic overall picture includes the consistent design of showers, changing rooms, foyers and also restaurants. There in particular, it is important to be able to freely combine different formats within a color system.

This is possible with the modular color system of Chroma and Plural. The range extends from mosaics, narrow strip tiles in various lengths to large formats. Rooms and surfaces can thus be scaled, elegantly proportioned and rhythmized. This makes it possible to design wall and floor surfaces across rooms.



Wellness + Spa

Natural wellness landscape
for highest demands



Spas and wellness oases are places of tranquillity and are designed for relaxing body and soul. With sweeping views of landscapes, analogies to pristine elements and natural materials, nature can be transferred to the room. Likewise with organic, original forms. They are reminiscent of soft formations or flowing movements of nature. Like that of water, for example. Smallest mosaic tiles, whether round or square, follow these forms and cover even the smallest curves like a skin.

In addition, the guests expect maximum hygiene and cleanliness in wellness and spa facilities. Ceramic tiles provided with Hytect help operators to achieve this goal in an environmentally friendly way. The surface of Hytect ceramics releases active oxygen naturally in interaction with light. This active oxygen inhibits the growth of mould and bacteria directly on the surface.



Hytect

Hydrophilic tiles for perfect hygiene

Wherever perfect hygiene is in demand, Hytect proves its worth. The tile coating for wall and floor tiles offers three advantages which are essential for swimming pool construction: it has an antibacterial effect, is extremely easy to clean and eliminates disagreeable odours.

Surfaces in swimming pools and spas are permanently exposed to water. Humid and warm ambient conditions are ideal for the growth of algae, fungi or germs, and it requires considerable time and effort especially in public swimming pools to maintain a high hygiene standard. With Hytect, AGROB BUCHTAL developed an effective solution for being able to design swimming pools which are hygienically clean, easy-care and odourless right from the beginning.

The technology is ecological and economical, because it relies on the natural power of the elements and makes use of something which virtually is available always and everywhere: light. The coating, which is unique in this form, is practically indestructible and ensures a clean ambience in the long term.

Hytect – the innovative solution

Hytect tiles can make an important contribution to hygiene and economic efficiency, because they help to

- impede the growth of mould, bacteria and other microorganisms,
- further facilitate the cleaning of the surface,
- eliminate air pollutants and odours in indoor areas.

And all that solely by the effect of light!



Ägeribad, Oberägeri, Switzerland
Architect: Scheitlin Syfrig Architekten AG / Photo: Adriano Faragulo



Pirbadet, Trondheim, Norway
Architect: Per Knudsen Arkitektkontor / Photo: Synlig design og foto as



Effective against fungi and bacteria

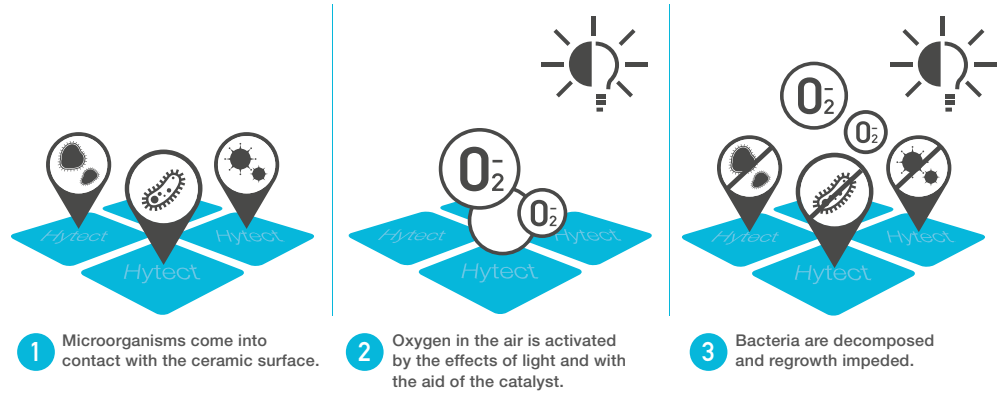

Extremely easy to clean

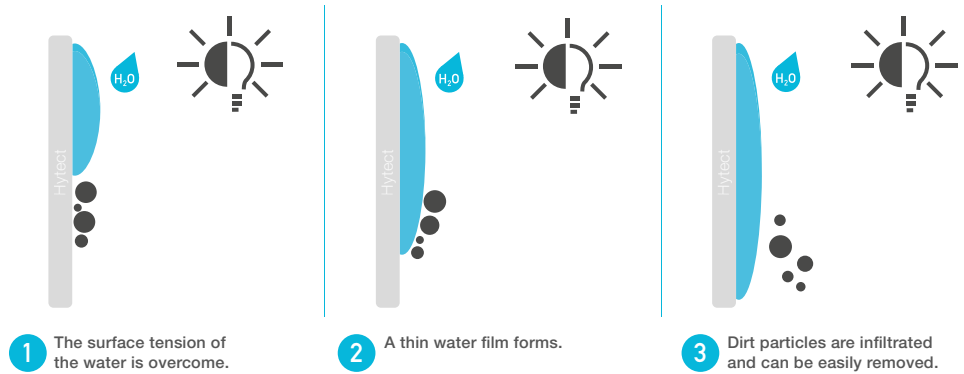

Active elimination of air pollutants

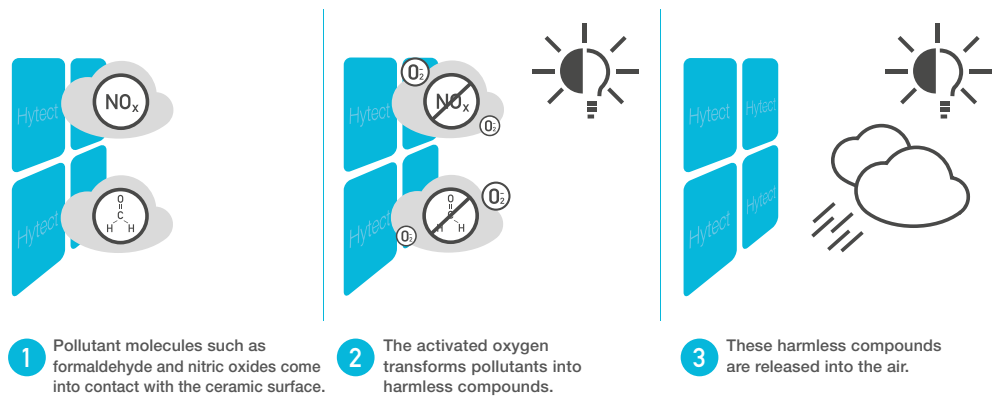





Product finder

Series	From Page	Product category															
		Floor tiles	Floor tiles extra thick	Shower floors	Mosaic	Skirtings	Patio tiles	Stair tiles	Wall tiles	Washbasins	Gutter tiles/covered gutter tiles	Ceramic cover grating	Grid profile tiles	Grooves tiles	Letter tiles	Overflow channels	Other swimming pool special pieces
Outlets + cover gratings	78																●
Amano*				●													
Area Pro*		●	●	●	●	●	●	●	●	●	●	●	●				
Ascona	128	●		●	●	●	●	●	●	●	●	●	●	●			
Basic Stone*				●													
BKS Bamberg	54															●	●
BKS Berlin**	62																
BKS Finland	22																●
BKS Finland II	28						●						●				●
BKS Skimmer **	70																
BKS St. Moritz**	58																
BKS Wiesbaden – Elevated water level	34																●
BKS Wiesbaden – Decreased water level	46																●
BKS Wiesbaden Silent	38																
BKS Wiesbaden Stil	42																●
BKS Wiesbaden – Therapy pools**	50																
BKS Zürich**	66																
Pool edging tiles	90																●
Chroma	142	●						●									
Chroma non-slip	152	●															
Chroma unglazed	162	●	●		●							●					●
Emotion*		●			●		●				●						
Fresh	224			●													
Skirtings Profiled edgings	94					●											●
Ceramic channel cover 2.0	80											●					
Loop	238			●													
Marble & More*				●													
Nova*		●		●	●		●										
Plural	170	●	●	●	●												
Plural non-slip	190	●	●	●	●												
Plural unglazed	198	●	●	●	●												
Quarzit	204	●		●	●	●	●		●	●	●	●	●	●			
Grooved tiles	102												●				
Savona	212	●		●	●												
Special tiles	108									●					●		●
Valley*		●		●	●	●	●				●						

* You will find this series in our 2024 programme of delivery

** This pool edge system is composed of components from several series. You will find details to this on the relevant information pages about the system.

Series	From page	Format																							
		Joint width: 3 mm	Joint width: 6 mm	1 x 1 cm	Ø 1 cm	2.5 x 2.5 cm	Ø 2 cm	5 x 5 cm	5 x 60 cm	6.2 x 25 cm	10 x 10 cm	10 x 20 cm	10 x 30 cm	10 x 40 cm	10 x 60 cm	12.5 x 12.5 cm	12.5 x 25 cm	12.5 x 50 cm	12.5 x 100 cm	15 x 15 cm	15 x 30 cm	15 x 60 cm	20 x 20 cm	20 x 40 cm	
Outlets + cover gratings	78																								
Amano*		•			•																				
Area Pro*		•				•				•				•					•		•	•			
Ascona	128	•	•				•								•	•			•						
Basic Stone*							•																		
BKS Bamberg	54		•																						
BKS Berlin**	62																								
BKS Finland	22		•																						
BKS Finland II	28		•													•									
BKS Skimmer **	70																								
BKS St. Moritz**	58																								
BKS Wiesbaden – Elevated water level	34		•																						
BKS Wiesbaden – Decreased water level	46		•																						
BKS Wiesbaden Silent	38																								
BKS Wiesbaden Stil	42		•																						
BKS Wiesbaden – Therapy pools**	50																								
BKS Zürich**	66																								
Pool edging tiles	90		•																						
Chroma	142		•						•						•	•	•								
Chroma non-slip	152		•												•	•									
Chroma unglazed	162		•												•	•									
Emotion*		•													•									•	
Fresh	224	•			•		•																		
Skirtings Profiled edgings	94		•																						
Ceramic channel cover 2.0	80																								
Loop	238	•		•		•																			
Marble & More*		•	•		•																				
Nova*		•					•							•					•		•				
Plural	170	•	•		•		•			•	•	•	•	•	•			•	•	•	•		•	•	•
Plural non-slip	190	•			•		•			•														•	
Plural unglazed	198	•			•		•			•													•	•	
Quarzit	204	•	•				•								•	•			•						
Grooved tiles	102		•												•										
Savona	212	•					•												•						
Special tiles	108		•												•	•									
Valley*		•	•				•	•							•				•		•				

* You will find this series in our 2024 programme of delivery

** This pool edge system is composed of components from several series. You will find details to this on the relevant information pages about the system.



POOL EDGE SYSTEMS

The right edge for every pool

Not all baths are the same: different types of use of sports, leisure and adventure pools, therapy baths, private and hotel pools or sports and competition pools require different pool planning concepts. They all demand a sophisticated design of the pool and its surround. This works with modularly combinable components. In addition to tiles for the surfaces, this also applies to ceramic pool edge systems. They are made of solid stoneware without cavities and are therefore particularly robust. Besides the classics, the range also includes innovations such as the energy-saving Bamberg system as well as a completely new prefabricated pool edge with a core made of carbon-reinforced concrete: AGROB BUCHTAL CarboCeram.

- System Finland I + II
- System Wiesbaden
- System Bamberg
- System St. Moritz
- System Berlin
- System Zürich
- System Skimmer
- NEW** • System AGROB BUCHTAL CarboCeram

BLU Sports and leisure pool, Potsdam, Germany
 Architect: GMP Gerkan, Marg und Partner, Berlin
 Series: Chroma, Pool edge system Wiesbaden, Plural / Photo: Jochen Stüber

The pool edge systems at a glance

System
Finnland

System
Finnland II

System
Wiesbaden

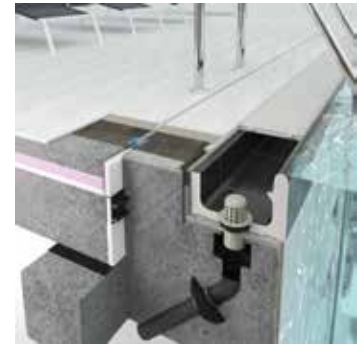

Sloping, beach-like pool edge with handhold-piece; covered channel with covered gutter tile and outlet valve SILENT 100.

Sloping, beach-like pool edge with handhold-piece and inclined grooved tile; covered channel with covered gutter tile and outlet valve SILENT 100.

Large overflow channel with handhold-piece, cover grating and outlet valve SILENT W 2000.

Type of pool

Sports and competition pools, leisure and adventure pools, open-air swimming pools.

Sports and competition pools, leisure and adventure pools, open-air swimming pools.

Leisure and adventure pools, thermal baths, open-air swimming pools.

Advantages for users and operators

Minimal wave rebound thanks to beach-like pool edge; different channel volumes (as required) are possible, easy exit due to elevated water level.

Minimal wave rebound thanks to beach-like pool edge; different channel volumes (as required) are possible, easy exit due to elevated water level.

Rational design thanks to large overflow channel, which combines all requirements (overflow edge, handhold-piece, channel, support for cover grating).

Variants *

Thanks to 150 mm and 119 mm wide special pieces and arrangement in several rows, different widths can be realized, also applicable in areas of radii. With the internal corner, the water circulation in corner areas can be optimized. In the case of this version, the corners are easier to clean. When used in private pools, also possible with ceramic channel cover.

Inclined grooved tile for simplified concrete construction, reduction of the number of joints in case of 50 cm long special pieces.

Large channel with mosaic recess, "low-noise channel" Wiesbaden Silent, small channel.

Available accessories

Outlet valve Silent 100, AGROB BUCHTAL plastic cover gratings.

Outlet valve Silent 100, AGROB BUCHTAL plastic cover gratings.

Outlet valve Silent W 2000, transverse grating in light-grey and white, special colors possible. "Inclined gratings" for the reduction of differences in height in areas of stairs and ramps.

* Special colors on request.

System
Wiesbaden Stil

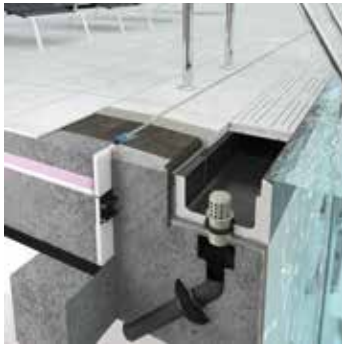

Large overflow channel with handhold-piece, ceramic channel cover and outlet valve SILENT W 2000.

Private and hotel pools.

Particularly aesthetic: channel cover made of ceramics in the same look as the covering of the pool surround. Aesthetically appealing design of the handhold-piece.

On request, also available with mosaic recess.

Outlet valve Silent W 2000.
Ceramic channel cover 2.0.

System
Wiesbaden
decreased water level



Large overflow channel with handhold-piece.

Private and hotel pools.

Particularly aesthetic: the version with decreased water level permits an additional "accumulation height" which is desired above all for the use of water attractions. Thus, this system is optimally suitable, for example, for pools with water slides.

Different channel cross-sections and dimensions expand the application possibilities, among other things, in case of elevated pool walls in flow channels.

Outlet valve Silent W 2000.

System
Wiesbaden,
therapy pools



Small overflow channel (without cover grating) with outlet valve SILENT W 2000.

Therapy pools,
pools with water slides etc.

In case of therapeutic applications, the system allows back-friendly working with the patient.

In case of therapeutic applications, the system allows back-friendly working with the patient.

Outlet valve Silent W 2000.

The pool edge systems at a glance

System Bamberg

System St. Moritz

System Berlin



Large overflow channel with handhold-piece, outlet (Ø 75 mm), without cover grating.

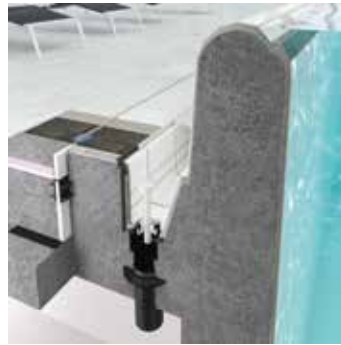

Elevated pool edge system with handhold-piece; overflow via the outside walls into a channel with cover grating.

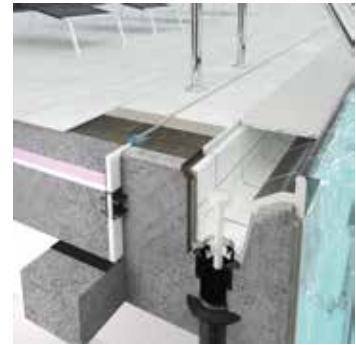

Elevated overflow edge as an ideal handhold; covered channel with "smooth" water inflow.

Type of pool

Leisure and adventure pools, thermal baths, private and hotel pools.

Leisure and adventure pools, private and hotel pools.

Leisure and adventure pools.

Advantages for users and operators

Consistent look through to the pool edge, as there are no cover gratings; low water consumption and considerably lower energy requirement; low noise level; rational design thanks to large overflow channel.

Lower foundation depth required, "elevated" pool, special "view" (Infinity Pool), different channel volumes (as required) are possible.

Overflow channel (cover grating) directly borders the pool; therefore, an alternative to the Wiesbaden channel; however, different channel volumes (as required) are possible.

Variants *

Different colors for handhold-piece and channel are possible; special colors are possible after a check.

Any pool edge widths and edge covers can be realized.

Different channel variants (width, depth) are possible.

Available accessories

Outlet valve Silent W 2000.

Outlet valve Silent 100, AGROB BUCHTAL plastic cover gratings.

Outlet valve Silent 100, AGROB BUCHTAL plastic cover gratings.

* Special colors on request.

System Zürich

System Skimmer

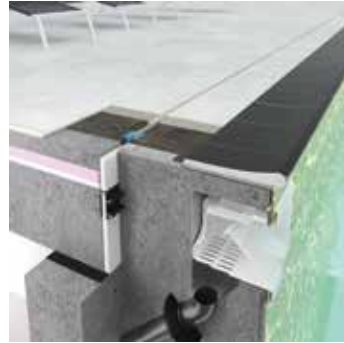

Elevated overflow edge as an ideal handhold; covered channel with covered gutter tile and outlet valve SILENT 100.

With pool edging tile Residence.

Leisure and adventure pools.

Private pools.

Different channel volumes (as required) are possible.

“Simple” rough concrete body, minimal effort for water technology (number of pipes).

Different pool edging tiles and channel variants are possible.

Pool edge designs with different special pieces are possible.

Outlet valve Silent 100, AGROB BUCHTAL plastic cover gratings.





All-rounder with beach effect

The Finland system and its variant Finland II are characterized by great versatility: both are ideally suited for sports and competition pools, adventure and open-air swimming pools. The sloping, beach-like pool edge reduces wave rebound and, in combination with the outlet valve Silent 100, helps to reduce the noise level in indoor swimming pools.

System Finland (classic)

The pool edge system with the sloping pool edge, which has been tried and tested for decades in a wide variety of pools, has an integrated handhold-piece and can also be used in radial areas. The elevated water level makes it easier for pool users to get out of the pool. Different channel volumes are possible depending on requirements.

Finnland (classic)

Thanks to 150 and 119 mm wide special pieces and arrangement in several rows, different widths can be realized. The outlet valve Silent 100 and plastic cover gratings are available as accessories. If used in private pools, a ceramic channel cover can also be used.

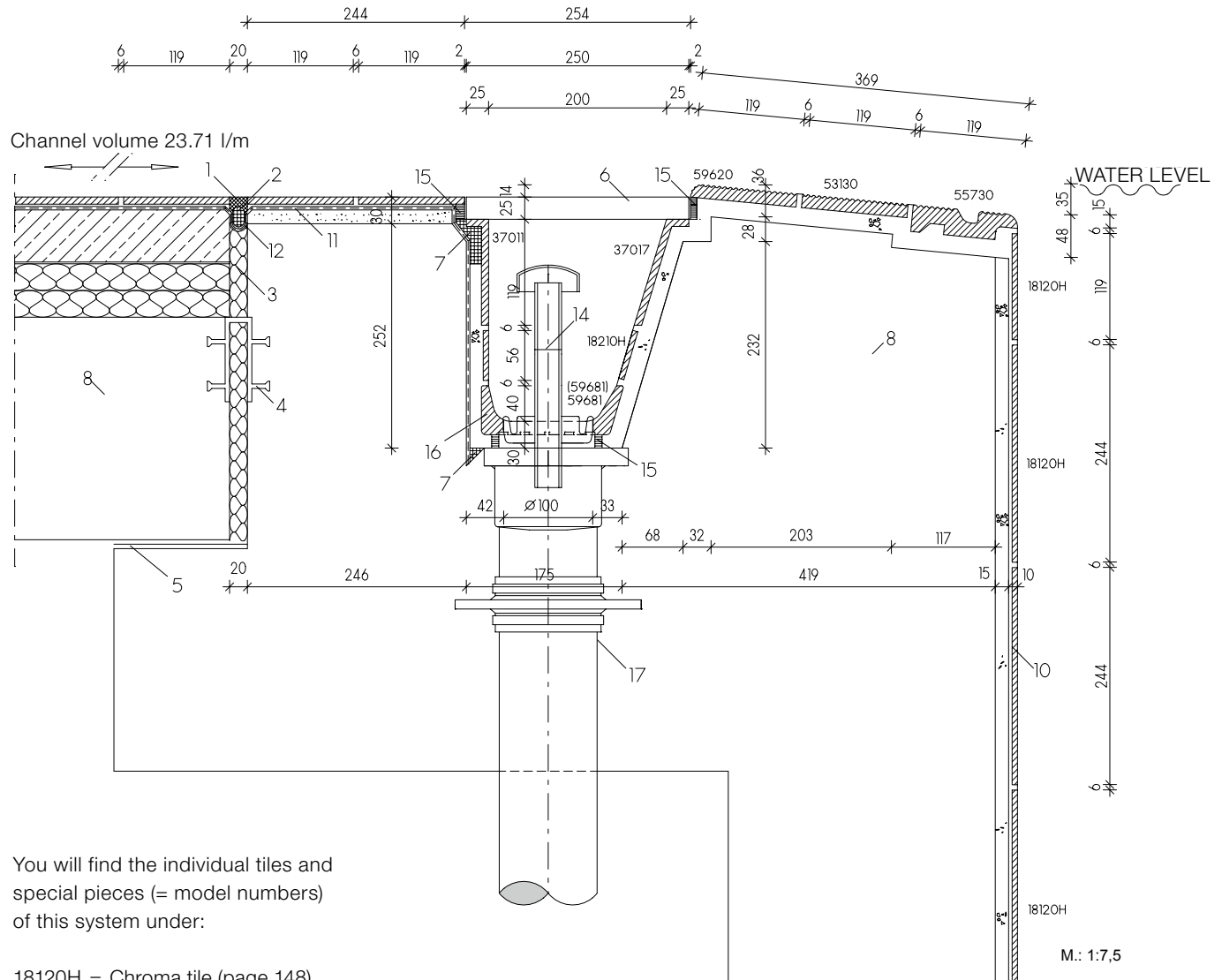

You will find the individual tiles and special pieces (= model numbers) of this system under:

- 18120H = Chroma tile (page 148)
- 55730 = Handhold-piece (page 25)
- 53130 = Grooved tile (page 106)
- 59620 = Grooved tile (page 107)
- 37017 = inclined shank-tile (page 113)
- 18210H = Chroma strip tile (page 150 ff)
- 59681 = Covered gutter tile with outlet (page 113)
- 37011 = Shank-tile (page 113)
- Cover grating (page 84)
- Outlet valve Silent 100 (page 86)

Legend:

- 01 UW-Silicone
- 02 Closed-cell polyethylene foam round lace
- 03 Elastic water-resistant filling material
- 04 Joint band
- 05 Slide bearing
- 06 AGROB BUCHTAL plastic cover grating
- 07 Capillary barrier/grouting (reaction resin filler)
- 08 Waterproof concrete (according to DIN EN 206/DIN 1045/DAfStB WU Guideline)
- 09 Conventional thick-bed laying
- 10 Thin-bed laying on cement render (P III, CS IV without added lime)
- 11 Sealing layer
- 12 Sealing tape
- 13 Outlet valve „Silent W 2000“ of AGROB BUCHTAL
- 14 AGROB BUCHTAL air inlet pipe for outlet „Silent 100“
- 15 Epoxi for joints (for the projekt sector)
- 16 AGROB BUCHTAL section stoneware pipe
- 17 Casing for water inlet/outlet pipe and brazing collar

Handhold-piece (119 mm wide) with non-slip safety marking



Handhold-piece	"Half-size" handhold-piece	Terminal piece left Corner radius 30 mm	Terminal piece right Corner radius 30 mm	Internal corner (mitred pair)	External corner (mitred pair) Corner radius 30 mm	Art. Nr. 55730
55730	55735	55737	55738	55732	55736	Model number
244 x 119 x 15/30 mm	119 x 119 x 15/30	244 x 119 x 15/30	244 x 119 x 15/30	(2x) 112 x 112 x 15/30	(2x) 236 x 119 x 15/30	Nom. dim. - cm
4.000	8.000					Work size mm
1.450/pieces	0.700/pieces	1.400/pieces	1.400/pieces	0.700/pair	2.000/pair	m - pieces
12 pieces	24 pieces	12 pieces	12 pieces	24 pairs	6 pairs	Pce./pair - kg
3.000	3.000					Bundle - pce./pair
17.400	16.800	16.800	16.800	16.800	12.000	Bundle - m
Alb	Alb	Alb	Alb	Alb	Alb	Bundle - kg
-/C	-/C	-/C	-/C	-/C	-/C	Product standard
553001-55730	553001-55735	553001-55737	553001-55738	553001-55732	553001-55736	Slip resistance
Price gr. A487 (pce.)	Price gr. A452 (pce.)	Price gr. A506 (pce.)	Price gr. A506 (pce.)	Price gr. A547 (pair)	Price gr. A615 (pair)	900 grey-beige
553002-55730	553002-55735	553002-55737	553002-55738	553002-55732	553002-55736	553001 active azure <input type="checkbox"/>
Price gr. A487 (pce.)	Price gr. A452 (pce.)	Price gr. A506 (pce.)	Price gr. A506 (pce.)	Price gr. A547 (pair)	Price gr. A615 (pair)	900 grey-beige
340-55730	340-55735	340-55737	340-55738	340-55732	340-55736	553002 light azure <input type="checkbox"/>
Price gr. A487 (pce.)	Price gr. A452 (pce.)	Price gr. A506 (pce.)	Price gr. A506 (pce.)	Price gr. A547 (pair)	Price gr. A615 (pair)	900 grey-beige
900567-55730	900567-55735	900567-55737	900567-55738	900567-55732	900567-55736	340 n1/black <input type="checkbox"/>
Price gr. A511 (pce.)	Price gr. A467 (pce.)	Price gr. A528 (pce.)	Price gr. A528 (pce.)	Price gr. A587 (pair)	Price gr. A645 (pair)	91 n10/white
900588-55730	900588-55735	900588-55737	900588-55738	900588-55732	900588-55736	553001 active azure <input type="checkbox"/>
Price gr. A511 (pce.)	Price gr. A467 (pce.)	Price gr. A528 (pce.)	Price gr. A528 (pce.)	Price gr. A587 (pair)	Price gr. A645 (pair)	91 n10/white
900044-55730	900044-55735	900044-55737	900044-55738	900044-55732	900044-55736	553002 light azure <input type="checkbox"/>
Price gr. A511 (pce.)	Price gr. A467 (pce.)	Price gr. A528 (pce.)	Price gr. A528 (pce.)	Price gr. A587 (pair)	Price gr. A645 (pair)	91 n10/white
						340 n1/black <input type="checkbox"/>



Handhold-piece (150 mm wide) with non-slip safety marking



Handhold-piece	"Half-size" handhold-piece	Terminal piece left Corner radius 30 mm	Terminal piece right Corner radius 30 mm	Internal corner (mitred pair)	External corner (mitred pair) Corner radius 30 mm	Art. Nr. 59420
59420	59425	59427	59428	59422	59426	Model number
244 x 150 x 15/30	119 x 150 x 15/30	244 x 150 x 15/30	244 x 150 x 15/30	(2x) 143 x 143 x 15/30	(2x) 236 x 150 x 15/30	Nom. dim. - cm
4.000	8.000					Work size mm
1.600/pieces	0.790/pieces	1.600/pieces	1.600/pieces	1.000/pair	2.100/pair	m - pieces
12 pieces	24 pieces	12 pieces	12 pieces	12 pairs	6 pairs	Pce./pair - kg
3.000	3.000					Bundle - pce./pair
19.200	18.960	19.200	19.200	12.000	12.600	Bundle - m
Alb	Alb	Alb	Alb	Alb	Alb	Bundle - kg
-/C	-/C	-/C	-/C	-/C	-/C	Product standard
553001-59420	553001-59425	553001-59427	553001-59428	553001-59422	553001-59426	Slip resistance
Price gr. A511 (pce.)	Price gr. A467 (pce.)	Price gr. A528 (pce.)	Price gr. A528 (pce.)	Price gr. A587 (pair)	Price gr. A645 (pair)	900 grey-beige
553002-59420	553002-59425	553002-59427	553002-59428	553002-59422	553002-59426	553001 active azure <input type="checkbox"/>
Price gr. A511 (pce.)	Price gr. A467 (pce.)	Price gr. A528 (pce.)	Price gr. A528 (pce.)	Price gr. A587 (pair)	Price gr. A645 (pair)	900 grey-beige
340-59420	340-59425	340-59427	340-59428	340-59422	340-59426	553002 light azure <input type="checkbox"/>
Price gr. A511 (pce.)	Price gr. A467 (pce.)	Price gr. A528 (pce.)	Price gr. A528 (pce.)	Price gr. A587 (pair)	Price gr. A645 (pair)	900 grey-beige
900567-59420	900567-59425	900567-59427	900567-59428	900567-59422	900567-59426	340 n1/black <input type="checkbox"/>
Price gr. A533 (pce.)	Price gr. A487 (pce.)	Price gr. A560 (pce.)	Price gr. A560 (pce.)	Price gr. A618 (pair)	Price gr. A668 (pair)	91 n10/white
900588-59420	900588-59425	900588-59427	900588-59428	900588-59422	900588-59426	553001 active azure <input type="checkbox"/>
Price gr. A533 (pce.)	Price gr. A487 (pce.)	Price gr. A560 (pce.)	Price gr. A560 (pce.)	Price gr. A618 (pair)	Price gr. A668 (pair)	91 n10/white
900044-59420	900044-59425	900044-59427	900044-59428	900044-59422	900044-59426	553002 light azure <input type="checkbox"/>
Price gr. A533 (pce.)	Price gr. A487 (pce.)	Price gr. A560 (pce.)	Price gr. A560 (pce.)	Price gr. A618 (pair)	Price gr. A668 (pair)	91 n10/white
						340 n1/black <input type="checkbox"/>

¹ For cover gratings, refer to page 84, covered gutter tiles refer to page 113

No pallet rebate is granted for the products shown on this page.



 The products shown on this page can also be produced in other colors of the series Chroma non-slip. We will be pleased to check the possibility of such a special production upon request.

Handhold-piece and edging tile (140 mm wide) with grating support and non-slip safety marking

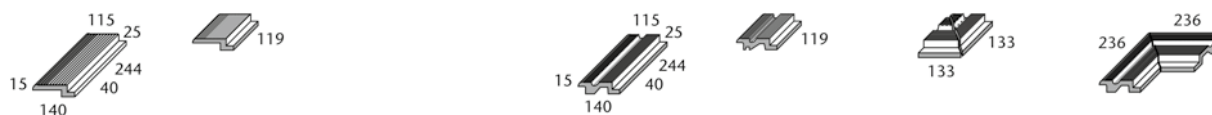

	Edging tile for art. 55760	Edging tile for art. 55765		Handhold-piece	"Half-size" handhold-piece	Internal corner (mitred pair)	External corner (mitred pair) Corner radius 30 mm
Model number	55770	55775		55760	55765	55762	55766
Nom. dim. - cm							
Work size mm	244 x 140 x 15/40	119 x 140 x 15/40		244 x 140 x 15/40	119 x 140 x 15/40	(2x) 133 x 133 x 15/40	(2x) 236 x 140 x 15/40
m - pieces	4.000	8.000		4.000	8.000		
Pce./pair - kg	1.300/pieces	0.780/pieces		1.550/pieces	0.780/pieces	1.000/pair	2.300/pair
Bundle - pce./pair	12 pieces	24 pieces		9 pieces	18 pieces	2 pairs	4 pairs
Bundle - m	3.000	3.000		2.250	2.250		
Bundle - kg	15.600	16.720		13.950	14.040	2.000	9.200
Product standard	Alb	Alb		Alb	Alb	Alb	Alb
Slip resistance	-/C	☒ -/C		-/C	☒ -/C	-/C	☒ -/C
900 grey-beige	553001-55770	553001-55775		553001-55760	553001-55765	553001-55762	553001-55766
553001 active azure	Price gr. A489 (pce.)	Price gr. A452 (pce.)		Price gr. A556 (pce.)	Price gr. A452 (pce.)	Price gr. A645 (pair)	Price gr. A683 (pair)
900 grey-beige	553002-55770	553002-55775		553002-55760	553002-55765	553002-55762	553002-55766
553002 light azure	Price gr. A489 (pce.)	Price gr. A452 (pce.)		Price gr. A556 (pce.)	Price gr. A452 (pce.)	Price gr. A645 (pair)	Price gr. A683 (pair)
900 grey-beige	340-55770	340-55775		340-55760	340-55765	340-55762	340-55766
340 n1/black	Price gr. A489 (pce.)	Price gr. A452 (pce.)		Price gr. A556 (pce.)	Price gr. A452 (pce.)	Price gr. A645 (pair)	Price gr. A683 (pair)
91 n10/white	900567-55770	900567-55775		900567-55760	900567-55765	900567-55762	900567-55766
553001 active azure	Price gr. A506 (pce.)	Price gr. A463 (pce.)		Price gr. A577 (pce.)	Price gr. A463 (pce.)	Price gr. A668 (pair)	Price gr. A705 (pair)
91 n10/white	900588-55770	900588-55775		900588-55760	900588-55765	900588-55762	900588-55766
553002 light azure	Price gr. A506 (pce.)	Price gr. A463 (pce.)		Price gr. A577 (pce.)	Price gr. A463 (pce.)	Price gr. A668 (pair)	Price gr. A705 (pair)
91 n10/white	900044-55770	900044-55775		900044-55760	900044-55765	900044-55762	900044-55766
340 n1/black	Price gr. A506 (pce.)	Price gr. A463 (pce.)		Price gr. A577 (pce.)	Price gr. A463 (pce.)	Price gr. A668 (pair)	Price gr. A705 (pair)



Edging tile with non-slip safety marking



	Edging tile	"Half-size" edging tile	Internal corner (mitred pair)	External corner (mitred pair)		
Model number	55720	55725	55722	55729		
Nom. dim. - cm						
Work size mm	244 x 140 x 20/50	119 x 140 x 20/50	(2x) 240 x 140 x 20/50	(2x) 133 x 133 x 20/50		
m - pieces	4.000	8.000				
Pce./pair - kg	1.500/pieces	0.730/pieces	2.200/pair	0.700/pair		
Bundle - pce./pair	10 pieces	20 pieces	5 pairs	4 pairs		
Bundle - m	2.500	2.500				
Bundle - kg	15.000	14.600	11.000	2.800		
Product standard	Alb	Alb	Alb	Alb		
Slip resistance	-/C	☒ -/C	-/C	☒ -/C		
900 grey-beige	553001-55720	553001-55725	553001-55722	553001-55729		
553001 active azure	Price gr. A528 (pce.)	Price gr. A480 (pce.)	Price gr. A668 (pair)	Price gr. A604 (pair)		
900 grey-beige	553002-55720	553002-55725	553002-55722	553002-55729		
553002 light azure	Price gr. A528 (pce.)	Price gr. A480 (pce.)	Price gr. A668 (pair)	Price gr. A604 (pair)		
900 grey-beige	340-55720	340-55725	340-55722	340-55729		
340 n1/black	Price gr. A528 (pce.)	Price gr. A480 (pce.)	Price gr. A668 (pair)	Price gr. A604 (pair)		
91 n10/white	900567-55720	900567-55725	900567-55722	900567-55729		
553001 active azure	Price gr. A556 (pce.)	Price gr. A506 (pce.)	Price gr. A708 (pair)	Price gr. A636 (pair)		
91 n10/white	900588-55720	900588-55725	900588-55722	900588-55729		
553002 light azure	Price gr. A556 (pce.)	Price gr. A506 (pce.)	Price gr. A708 (pair)	Price gr. A636 (pair)		
91 n10/white	900044-55720	900044-55725	900044-55722	900044-55729		
340 n1/black	Price gr. A556 (pce.)	Price gr. A506 (pce.)	Price gr. A708 (pair)	Price gr. A636 (pair)		

¹ For cover gratings, refer to page 84



No pallet rebate is granted for the products shown on this page.



The products shown on this page can also be produced in other colors of the series Chroma non-slip. We will be pleased to check the possibility of such a special production upon request.

Edging tile with grating support and non-slip safety marking

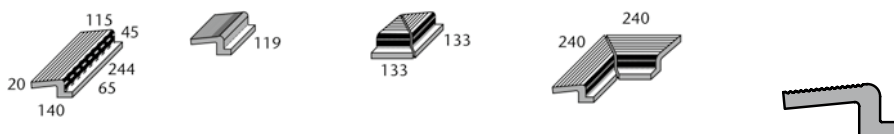

Edging tile	"Half-size" edging tile	Internal corner (mitred pair)	External corner (mitred pair)	Art. Nr. 55740
55740	55745	55742	55749	Model number
244 x 140 x 20/65	119 x 140 x 20/65	(2x) 133 x 133 x 20/65	(2x) 240 x 140 x 20/65	Nom. dim. - cm
4.000	8.000			Work size mm
1.850/pieces	0.900/pieces	0.900/pair	2.700/pair	m - pieces
6 pieces	12 pieces	4 pairs	3 pairs	Pce./pair - kg
1.500	1.500			Bundle - pce./pair
11.100	10.800	3.600	8.100	Bundle - m
Alb	Alb	Alb	Alb	Bundle - kg
-/C	-/C	-/C	-/C	Product standard
553001-55740	553001-55745	553001-55742	553001-55749	Slip resistance
Price gr. A556 (pce.)	Price gr. A506 (pce.)	Price gr. A645 (pair)	Price gr. A683 (pair)	900 grey-beige
553002-55740	553002-55745	553002-55742	553002-55749	553001 active azure <input type="checkbox"/> VO
Price gr. A556 (pce.)	Price gr. A506 (pce.)	Price gr. A645 (pair)	Price gr. A683 (pair)	900 grey-beige
340-55740	340-55745	340-55742	340-55749	553002 light azure <input type="checkbox"/> VO
Price gr. A556 (pce.)	Price gr. A506 (pce.)	Price gr. A645 (pair)	Price gr. A683 (pair)	900 grey-beige
900567-55740	900567-55745	900567-55742	900567-55749	340 n1/black <input type="checkbox"/> VO
Price gr. A577 (pce.)	Price gr. A511 (pce.)	Price gr. A668 (pair)	Price gr. A708 (pair)	91 n10/white
900588-55740	900588-55745	900588-55742	900588-55749	553001 active azure <input type="checkbox"/> VO
Price gr. A577 (pce.)	Price gr. A511 (pce.)	Price gr. A668 (pair)	Price gr. A708 (pair)	91 n10/white
900044-55740	900044-55745	900044-55742	900044-55749	553002 light azure <input type="checkbox"/> VO
Price gr. A577 (pce.)	Price gr. A511 (pce.)	Price gr. A668 (pair)	Price gr. A708 (pair)	91 n10/white
				340 n1/black <input type="checkbox"/> VO



Edging tile with grating support

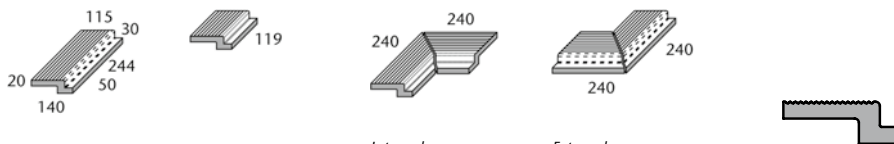

Edging tile	"Half-size" edging tile	Internal corner (mitred pair)	External corner (mitred pair)	Art. Nr. 55750
55750	55755	55752	55759	Model number
244 x 140 x 20/50	119 x 140 x 20/50	(2x) 240 x 140 x 20/50	(2x) 240 x 140 x 20/50	Nom. dim. - cm
4.000	8.000			Work size mm
1.780/pieces	0.880/pieces	2.600/pair	2.600/pair	m - pieces
8 pieces	16 pieces	4 pairs	4 pairs	Pce./pair - kg
2.000	2.000			Bundle - pce./pair
14.240	14.080	10.400	10.400	Bundle - m
Alb	Alb	Alb	Alb	Bundle - kg
-/C	-/C	-/C	-/C	Product standard
900-55750	900-55755	900-55752	900-55759	Slip resistance
Price gr. A539 (pce.)	Price gr. A487 (pce.)	Price gr. A663 (pair)	Price gr. A663 (pair)	grey-beige <input type="checkbox"/> VO
91-55750	91-55755	91-55752	91-55759	neutral 10 <input type="checkbox"/> VO
Price gr. A560 (pce.)	Price gr. A506 (pce.)	Price gr. A689 (pair)	Price gr. A689 (pair)	(active white) <input type="checkbox"/> VO

¹ For cover gratings, refer to page 84

No pallet rebate is granted for the products shown on this page.



 The products shown on this page can also be produced in other colors of the series Chroma non-slip. We will be pleased to check the possibility of such a special production upon request.

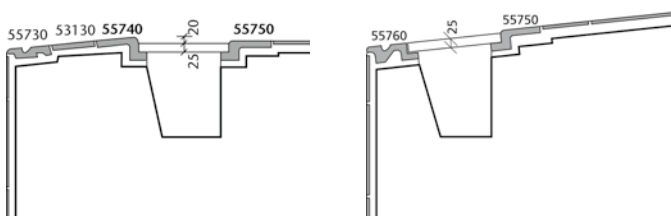





A classic rethought

The further development of the world-wide popular classic Finland (cf. p. 22 ff) is just as universally applicable. An important difference in detail is the inclined grooved tile. Its wedge-shaped longitudinal section decisively facilitates the construction of the concrete structure: the upper side of the pool wall can be executed horizontally. The grooved tile then provides the necessary slope towards the pool. Reduced wave action and the elevated water level ensure increased comfort during swimming and when leaving the pool here, too. The 500 mm long special pieces, which reduce the number of joints, also speak in favour of Finland II. Instead of the standard plastic cover gratings, the use of ceramic channel covers is also possible for private pools (see system Wiesbaden Stil on p. 42 ff).

Finnland II (inclined grooved tile)

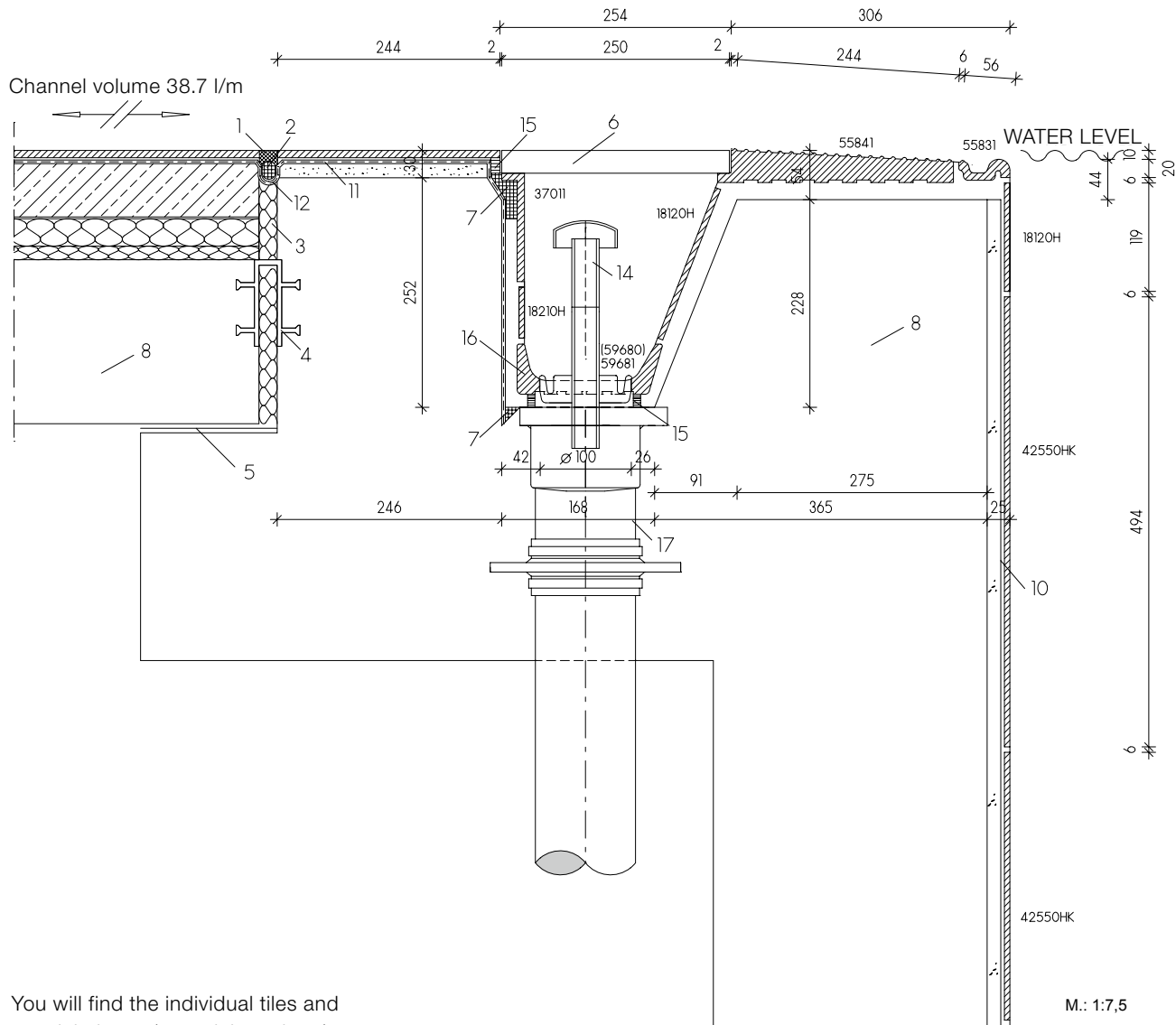

You will find the individual tiles and special pieces (= model numbers) of this system under:

- 42550HK = Chroma tile (page 148 ff)
- 55831 = Handhold-piece (page 31)
- 55841 = inclined grooved tile (page 32)
- 18120H = Chroma tile (page 148 ff)
- 59681 = Coved gutter tile with outlet (page 113)
- 18210H = Chroma strip tile (page 148 ff)
- 37011 = Shank-tile (page 113)
- Cover grating (page 84)
- Outlet valve Silent 100 (page 86)

Legend:

- 01 UW-Silicone
- 02 Closed-cell polyethylene foam round lace
- 03 Elastic water-resistant filling material
- 04 Joint band
- 05 Slide bearing

- 06 AGROB BUCHTAL plastic cover grating
- 07 Capillary barrier/grouting (reaction resin filler)
- 08 Waterproof concrete (according to DIN EN 206/DIN 1045/DAfStB WU Guideline)
- 09 Conventional thick-bed laying
- 10 Thin-bed laying on cement render (P III, CS IV without added lime)
- 11 Sealing layer
- 12 Sealing tape
- 13 Outlet valve „Silent W 2000“ of AGROB BUCHTAL
- 14 Air inlet pipe for outlet „Silent 100“
- 15 Epoxi for joints (for the projekt sector)
- 16 AGROB BUCHTAL section stoneware pipe
- 17 Casing for water inlet/outlet pipe and brazing collar

Handhold-piece



		Handhold-piece 50 cm	Handhold-piece 25 cm	Handhold-piece 12,5 cm	Internal corner (mitred pair)	External corner (mitred pair) Corner radius 30 mm	Art. no. 55830
		55831	55830	55835	55832	55836	Model number
		494 x 56 x 20/12.5	244 x 56 x 20/12.5	119 x 56 x 20/12.5	(2x) 49 x 49 x 20/12.5	(2x) 236 x 56 x 20/12.5	Nom. dim. - cm
		2.000	4.000	8.000			Work size mm
		0.910/pieces	0.450/pieces	0.220/pieces	0.080/pair	0.790/pair	m - pieces
		8 pieces	28 pieces	56 pieces	18 pairs	14 pairs	Pce./pair - kg
		4.000	7.000	7.000			Bundle - pce./pair
		7.280	12.600	12.320	1.440	11.060	Bundle - m
		Alb	Alb	Alb	Alb	Alb	Bundle - kg
		-/C	-/C	-/C	-/C	-/C	Product standard
		553001-55831	553001-55830	553001-55835	553001-55832	553001-55836	Slip resistance
		Price gr. A514 (pce.)	Price gr. A471 (pce.)	Price gr. A441 (pce.)	Price gr. A519 (pair)	Price gr. A581 (pair)	active azure <input type="checkbox"/>
		553002-55831	553002-55830	553002-55835	553002-55832	553002-55836	light azure <input type="checkbox"/>
		Price gr. A514 (pce.)	Price gr. A471 (pce.)	Price gr. A441 (pce.)	Price gr. A519 (pair)	Price gr. A581 (pair)	neutral 1 <input type="checkbox"/>
		340-55831	340-55830	340-55835	340-55832	340-55836	(deep black) <input type="checkbox"/>
		Price gr. A514 (pce.)	Price gr. A471 (pce.)	Price gr. A441 (pce.)	Price gr. A519 (pair)	Price gr. A581 (pair)	



Edging tile, stair tread

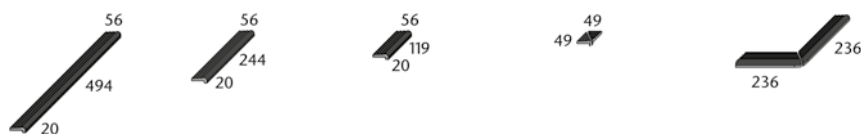

		Handhold-piece 50 cm	Handhold-piece 25 cm	Handhold-piece 12,5 cm	Internal corner (mitred pair)	External corner (mitred pair) Corner radius 30 mm	Art. no. 55820
		55821	55820	55825	55822	55826	Model number
		494 x 56 x 20/12.5	244 x 56 x 20/12.5	119 x 56 x 20/12.5	(2x) 49 x 49 x 20/12.5	(2x) 236 x 56 x 20/12.5	Nom. dim. - cm
		2.000	4.000	8.000			Work size mm
		0.770/pieces	0.380/pieces	0.190/pieces	0.100/pair	0.620/pair	m - pieces
		12 pieces	42 pieces	84 pieces	18 pairs	14 pairs	Pce./pair - kg
		6.000	10.500	10.500			Bundle - pce./pair
		9.240	15.960	15.960	1.440	11.060	Bundle - m
		Alb	Alb	Alb	Alb	Alb	Bundle - kg
		-/C	-/C	-/C	-/C	-/C	Product standard
		553001-55821	553001-55820	553001-55825	553001-55822	553001-55826	Slip resistance
		Price gr. A475 (pce.)	Price gr. A441 (pce.)	Price gr. A425 (pce.)	Price gr. A484 (pair)	Price gr. A528 (pair)	active azure <input type="checkbox"/>
		553002-55821	553002-55820	553002-55825	553002-55822	553002-55826	light azure <input type="checkbox"/>
		Price gr. A475 (pce.)	Price gr. A441 (pce.)	Price gr. A425 (pce.)	Price gr. A484 (pair)	Price gr. A528 (pair)	neutral 1 <input type="checkbox"/>
		340-55821	340-55820	340-55825	340-55822	340-55826	(deep black) <input type="checkbox"/>
		Price gr. A475 (pce.)	Price gr. A441 (pce.)	Price gr. A425 (pce.)	Price gr. A484 (pair)	Price gr. A528 (pair)	

¹ For cover gratings, refer to page 84, for the covered gutter tiles refer to page 113

No pallet rebate is granted for the products shown on this page.



 The products shown on this page can also be produced in other colors of the series Chroma non-slip. We will be pleased to check the possibility of such a special production upon request.

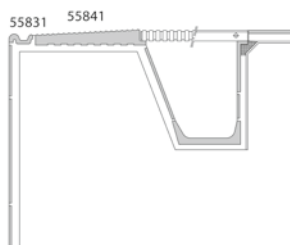

Inclined grooved tile for continuing the Pool Edge System „Finland II“²

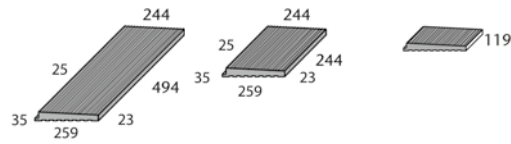

Grooved Tiles 12.5 mm thick, for continuing the Pool Edge System „Finland II“²

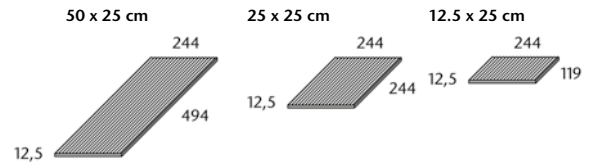

	grooved 50 cm	grooved 25 cm	grooved 12,5 cm	grooved 50 x 25	grooved 25 x 25	grooved 12,5 x 25
Model number	55841	55840	55845	53151	53150	53159
Nom. dim. - cm/in				50 x 25 / 20 x 10	25 x 25 / 10 x 10	12,5 x 25 / 5 x 10
Work size mm	494 x 244 x 23/35	244 x 244 x 23/35	119 x 244 x 23/35	494 x 244 x 12.5	244 x 244 x 12.5	119 x 244 x 12.5
m - pieces	2.000	4.000	8.000	2.000	4.000	8.000
Pieces - kg	8.100	3.950	1.930	3.550	1.775	0.888
Bundle - pieces	2	6	12	6	9	21
Bundle - m	1.000	1.500	1.500	3.000	2.250	2.625
Bundle - kg	16.200	23.700	37.306	21.300	15.975	18.648
Product standard	Alb	Alb	Alb	Alb	Alb	Alb
Slip resistance	-/C	-/C	-/C	see below	see below	see below
grey-beige	900-55841⁴ Price gr. A638 (pce.)	900-55840⁴ Price gr. A556 (pce.)	900-55845⁴ Price gr. A506 (pce.)	-/C 900-53151⁴ Price gr. A463 (pce.)	-/C 900-53150⁴ Price gr. A430 (pce.)	-/C 900-53159⁴ Price gr. A410 (pce.)
neutral 10 (active white)	91-55841 Price gr. A663 (pce.)	91-55840 Price gr. A573 (pce.)	91-55845 Price gr. A511 (pce.)	-/C 91-53151 Price gr. A528 (pce.)	-/C 91-53150 Price gr. A465 (pce.)	-/C 91-53159 Price gr. A423 (pce.)
active azure	553001-55841 Price gr. A683 (pce.)	553001-55840 Price gr. A587 (pce.)	553001-55845 Price gr. A519 (pce.)	-/C 553001-53151 Price gr. A545 (pce.)	-/C 553001-53150 Price gr. A471 (pce.)	-/C 553001-53159 Price gr. A426 (pce.)
light azure	553002-55841 Price gr. A683 (pce.)	553002-55840 Price gr. A587 (pce.)	553002-55845 Price gr. A519 (pce.)	-/C 553002-53151 Price gr. A545 (pce.)	-/C 553002-53150 Price gr. A471 (pce.)	-/C 553002-53159 Price gr. A426 (pce.)
neutral 1 (deep black)	340-55841 Price gr. A683 (pce.)	340-55840 Price gr. A587 (pce.)	340-55845 Price gr. A519 (pce.)	-/C 340-53151 Price gr. A545 (pce.)	-/C 340-53150 Price gr. A471 (pce.)	-/C 340-53159 Price gr. A426 (pce.)
Area Pro anthracite				R11/C 435601H ^{1/5/6} Price gr. A560 (pce.)	R11/C 435613H ^{1/5/6} Price gr. A480 (pce.)	R11/C 435625H ^{1/5/6} Price gr. A430 (pce.)
Area Pro basalt				R11/C 435602H ^{1/5/6} Price gr. A560 (pce.)	R11/C 435614H ^{1/5/6} Price gr. A480 (pce.)	R11/C 435626H ^{1/5/6} Price gr. A430 (pce.)
Area Pro pebble				R11/C 435603H ^{1/5/6} Price gr. A560 (pce.)	R11/C 435615H ^{1/5/6} Price gr. A480 (pce.)	R11/C 435627H ^{1/5/6} Price gr. A430 (pce.)
Area Pro stone				R11/C 435604H ^{1/5/6} Price gr. A560 (pce.)	R11/C 435616H ^{1/5/6} Price gr. A480 (pce.)	R11/C 435628H ^{1/5/6} Price gr. A430 (pce.)
Area Pro sand-white				R11/C 435605H ^{1/5/6} Price gr. A560 (pce.)	R11/C 435617H ^{1/5/6} Price gr. A480 (pce.)	R11/C 435629H ^{1/5/6} Price gr. A430 (pce.)
Area Pro sand-grey				R11/C 435606H ^{1/5/6} Price gr. A560 (pce.)	R11/C 435618H ^{1/5/6} Price gr. A480 (pce.)	R11/C 435630H ^{1/5/6} Price gr. A430 (pce.)
Area Pro sand				R11/C 435607H ^{1/5/6} Price gr. A560 (pce.)	R11/C 435619H ^{1/5/6} Price gr. A480 (pce.)	R11/C 435631H ^{1/5/6} Price gr. A430 (pce.)
Area Pro nutmeg				R11/C 435608H ^{1/5/6} Price gr. A560 (pce.)	R11/C 435620H ^{1/5/6} Price gr. A480 (pce.)	R11/C 435632H ^{1/5/6} Price gr. A430 (pce.)
Area Pro platinum				R11/C 435609H ^{1/5/6} Price gr. A560 (pce.)	R11/C 435621H ^{1/5/6} Price gr. A480 (pce.)	R11/C 435633H ^{1/5/6} Price gr. A430 (pce.)
Area Pro sand-beige				R11/C 435610H ^{1/5/6} Price gr. A560 (pce.)	R11/C 435622H ^{1/5/6} Price gr. A480 (pce.)	R11/C 435634H ^{1/5/6} Price gr. A430 (pce.)
Area Pro brick				R11/C 435611H ^{1/5/6} Price gr. A560 (pce.)	R11/C 435623H ^{1/5/6} Price gr. A480 (pce.)	R11/C 435635H ^{1/5/6} Price gr. A430 (pce.)
Area Pro clay				R11/C 435612H ^{1/5/6} Price gr. A560 (pce.)	R11/C 435624H ^{1/5/6} Price gr. A480 (pce.)	R11/C 435636H ^{1/5/6} Price gr. A430 (pce.)



1 2 Short edge rectified

³ For cover gratings, refer to page 84, coved gutter tiles refer to page 113

⁴ These articles comply with DIN EN 14411, group Al_b, unglazed (UGL)

⁵ These articles comply with DIN EN 14411, group Al_a, unglazed (UGL)

⁶ Hytect coated

No pallet rebate is granted for the products shown on this page.



The products shown on this page can also be produced in other colors of the series Chroma non-slip. We will be pleased to check the possibility of such a special production upon request.

Grooved Tiles 12.5 mm thick,
for continuing the Pool Edge System
„Finland II“^{1/2}

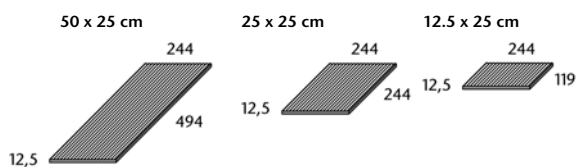

			grooved	grooved	grooved	
			53151	53150	53159	Model number
			50 x 25 / 20 x 10	25 x 25 / 10 x 10	12.5 x 25 / 5 x 10	Nom. dim. - cm/in
			494 x 244 x 12.5	244 x 244 x 12.5	119 x 244 x 12.5	Work size mm
			2.000	4.000	8.000	m - pieces
			3.550	1.775	0.888	Pieces - kg
			6	9	21	Bundle - pieces
			3.000	2.250	2.625	Bundle - m
			21.300	15.975	18.648	Bundle - kg
			Ala	Ala	Ala	Product standard
			R11/C	R11/C	R11/C	Slip resistance
			430789H	430793H	430802H	Ascona
			Price gr. A560 (pce.)	Price gr. A480 (pce.)	Price gr. A430 (pce.)	pearl <input type="checkbox"/> V3
			430790H	430794H	430803H	Ascona
			Price gr. A560 (pce.)	Price gr. A480 (pce.)	Price gr. A430 (pce.)	mud <input type="checkbox"/> V3
			430791H	430795H	430804H	Ascona
			Price gr. A560 (pce.)	Price gr. A480 (pce.)	Price gr. A430 (pce.)	stone <input type="checkbox"/> V3
			430792H	430796H	430805H	Ascona
			Price gr. A560 (pce.)	Price gr. A480 (pce.)	Price gr. A430 (pce.)	graphite <input type="checkbox"/> V3
			431551H	431553H	431555H	Ascona
			Price gr. A560 (pce.)	Price gr. A480 (pce.)	Price gr. A430 (pce.)	shell <input type="checkbox"/> V3
			431552H	431554H	431556H	Ascona
			Price gr. A560 (pce.)	Price gr. A480 (pce.)	Price gr. A430 (pce.)	sand <input type="checkbox"/> V3
			8460-53151	8460-53150	8460-53159	Quarzit
			Price gr. A560 (pce.)	Price gr. A480 (pce.)	Price gr. A430 (pce.)	basalt-grey <input type="checkbox"/> V4
			8461-53151	8461-53150	8461-53159	Quarzit
			Price gr. A560 (pce.)	Price gr. A480 (pce.)	Price gr. A430 (pce.)	quarz-grey <input type="checkbox"/> V4
			8462-53151	8462-53150	8462-53159	Quarzit
			Price gr. A560 (pce.)	Price gr. A480 (pce.)	Price gr. A430 (pce.)	sand-beige <input type="checkbox"/> V4
			8463-53151	8463-53150	8463-53159	Quarzit
			Price gr. A560 (pce.)	Price gr. A480 (pce.)	Price gr. A430 (pce.)	sepia-brown <input type="checkbox"/> V4
			8464-53151	8464-53150	8464-53159	Quarzit
			Price gr. A560 (pce.)	Price gr. A480 (pce.)	Price gr. A430 (pce.)	white-grey <input type="checkbox"/> V4



Short edge rectified



³ For cover gratings, refer to page 84, covered gutter tiles refer to page 113

No pallet rebate is granted for the products shown on this page.





Whispering specialists

With four different versions, the Wiesbaden system also meets special requirements, for example for therapy pools or flow channels. Equipped with the outlet valve Silent W 2000, Wiesbaden audibly reduces the noise level in indoor swimming pools.

Pool edge system Wiesbaden with elevated water level

Proven in leisure and adventure pools as well as in thermal and open-air pools, this system is convincing, among other things, because of its rational design. The large overflow channel combines all requirements in a single construction element: overflow edge, handhold-piece and channel. This saves time and money in pool construction. Like all AGROB BUCHTAL pool edge systems, the Wiesbaden overflow channel is manufactured without cavities and is therefore particularly robust.

Wiesbaden with elevated water level

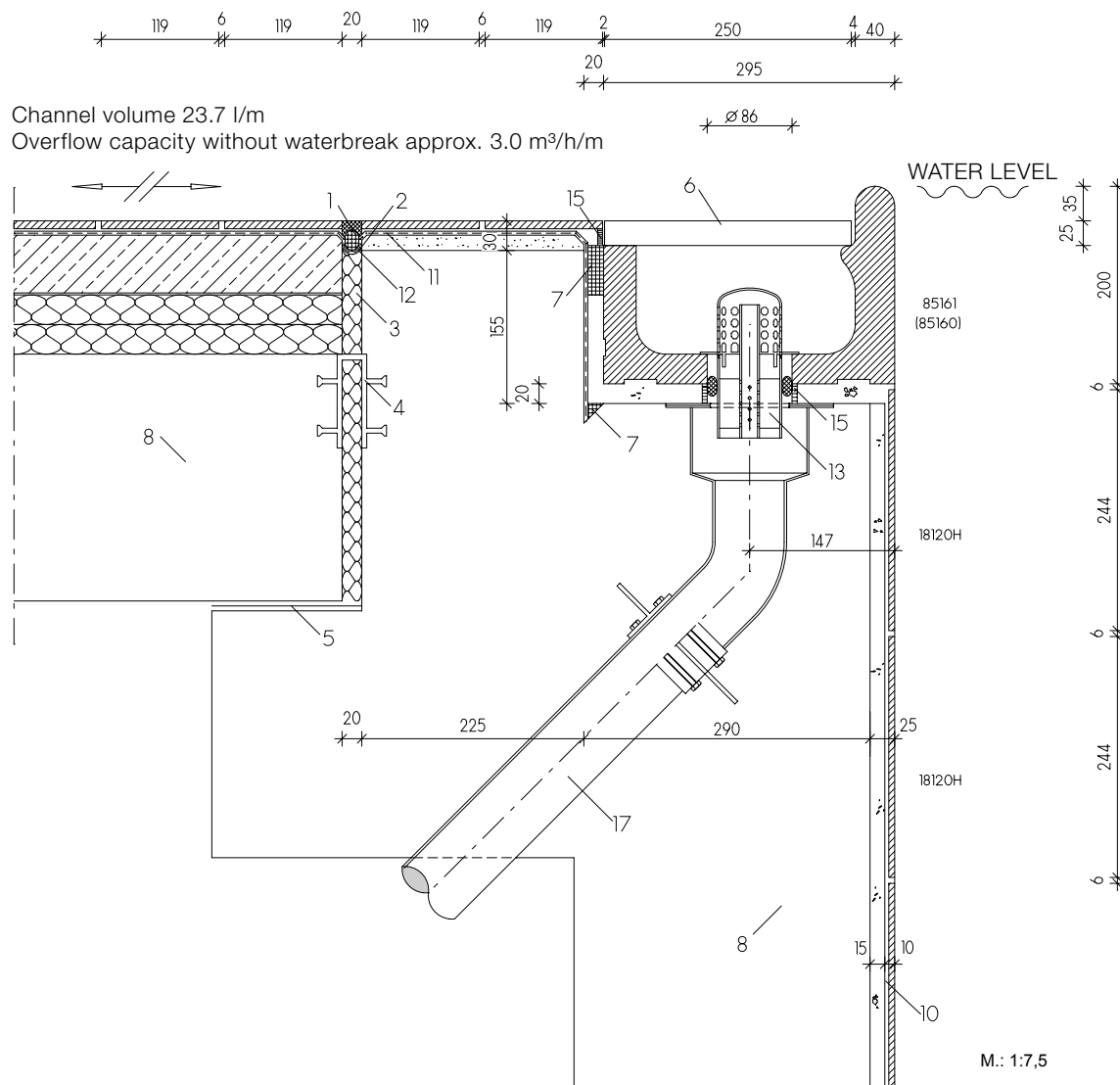

You will find the individual tiles and special pieces (= model numbers) of this system under:

- 18120H = Chroma tile (page 148 ff)
- 85160 = Overflow channel (page 37)
- 85161 = Overflow channel with outlet (page 37)
- Cover grating (page 84)
- Outlet valve Silent W 2000 (page 86)







Legend:

- 01 UW-Silicone
- 02 Closed-cell polyethylene foam round lace
- 03 Elastic water-resistant filling material
- 04 Joint band
- 05 Slide bearing
- 06 AGROB BUCHTAL plastic cover grating
- 07 Capillary barrier/grouting (reaction resin filler)

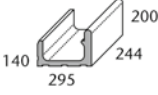
- 08 Waterproof concrete (according to DIN EN 206/DIN 1045/DAfStB WU Guideline)
- 09 Conventional thick-bed laying
- 10 Thin-bed laying on cement render (P III, CS IV without added lime)
- 11 Sealing layer
- 12 Sealing tape
- 13 Outlet valve „Silent W 2000“ of AGROB BUCHTAL
- 14 Air inlet pipe for outlet „Silent 100“
- 15 Epoxi for joints (for the projekt sector)
- 16 AGROB BUCHTAL section stoneware pipe
- 17 Casing for water inlet/outlet pipe and brazing collar

Large Channel

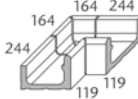
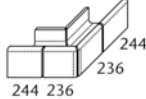



(Cover grating width 250 mm, see page 84)

							
Overflow channel ¹	"Half-size" overflow channel	Outlet (Ø 86 mm) ^{2/3}	Outlet (Ø 86 mm) ²	Terminal inlay left/ terminal inlay right	Internal corner (mitred pair, 4 parts)	External corner (mitred pair, 4 parts) Corner radius 30 mm	Art. no. 85160
85160	85165	85161	85163	85167/85168	S85162	85166	Model number
244 x 295 x 200/140	119 x 295 x 200/140	244 x 295 x 200/140	119 x 295 x 200/140	dim. as channel	(2x)414/119x295x200/140	(2x) 486 x 295 x 200/140	Nom. dim. - cm
4.000	8.000						Work size mm
10.300/pieces	5.000/pieces	10.000/pieces	4.700/pieces	0.300/pieces	20.500/pair	30.000/pair	m - pieces
1 piece	2 pieces	1 piece	2 pieces		1 pair	1 pair	Pce./pair - kg
0.250	0.250						Bundle - pce./pair
10.300	10.000	10.000	9.400		20.500	30.000	Bundle - m
Alb	Alb	Alb	Alb	Alb	Alb	Alb	Bundle - kg
700-85160	700-85165	700-85161	700-85163	700-85167/68	700-S85162	700-85166	Product standard
Price gr. A649 (pce.)	Price gr. A581 (pce.)	Price gr. A668 (pce.)	Price gr. A625 (pce.)	Price gr. A484 (pce.)	Price gr. A792 (pair)	Price gr. A792 (pair)	neutral 10 (active
701-85160	701-85165	701-85161	701-85163	701-85167/68	701-S85162	701-85166	white glossy) <input type="checkbox"/>
Price gr. A649 (pce.)	Price gr. A581 (pce.)	Price gr. A668 (pce.)	Price gr. A625 (pce.)	Price gr. A484 (pce.)	Price gr. A792 (pair)	Price gr. A792 (pair)	neutral 10 (active
552001-85160	552001-85165	552001-85161	552001-85163	552001-85167/68	552001-S85162	552001-85166	white matt) <input type="checkbox"/>
Price gr. A654 (pce.)	Price gr. A587 (pce.)	Price gr. A683 (pce.)	Price gr. A629 (pce.)	Price gr. A489 (pce.)	Price gr. A800 (pair)	Price gr. A800 (pair)	active azure) <input type="checkbox"/>
552002-85160	552002-85165	552002-85161	552002-85163	552002-85167/68	552002-S85162	552002-85166	light azure) <input type="checkbox"/>
Price gr. A654 (pce.)	Price gr. A587 (pce.)	Price gr. A683 (pce.)	Price gr. A629 (pce.)	Price gr. A489 (pce.)	Price gr. A800 (pair)	Price gr. A800 (pair)	neutral 1
5716-85160⁴	5716-85165⁴	5716-85161⁴	5716-85163⁴	5716-85167/68⁴	5716-S85162⁴	5716-85166⁴	(deep black) <input type="checkbox"/>
Price gr. A654 (pce.)	Price gr. A587 (pce.)	Price gr. A683 (pce.)	Price gr. A629 (pce.)	Price gr. A489 (pce.)	Price gr. A800 (pair)	Price gr. A800 (pair)	

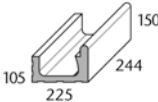

Small Channel

(Cover grating width 191 mm, see page 84)

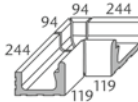
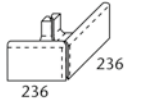
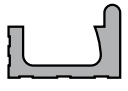
							
Overflow channel	"Half-size" overflow channel	Outlet (Ø 86 mm) ²	Outlet (Ø 86 mm) ²	Terminal inlay left/ terminal inlay right	Internal corner (mitred pair, 4 parts)	External corner (mitred pair, 4 parts) Corner radius 30 mm	Art. no. 55180
55180	55185	55181	S50044	55187/55188	S55182	55186	Model number
244 x 225 x 150/105	119 x 225 x 150/105	244 x 225 x 150/105	119 x 225 x 150/105	dim. as channel	(2x)344/119x225x150/105	(2x) 236x225x150/105	Nom. dim. - cm
4.000	8.000						Work size mm
7.000/pieces	3.425/pieces	6.600/pieces	3.100/pieces	0.200/pieces	11.800/pair	8.300/pair	m - pieces
1 piece	2 pieces	1 piece	2 pieces		1 pair	1 pair	Pce./pair - kg
0.250	0.250						Bundle - pce./pair
7.000	6.860	6.600	6.200		11.800	8.300	Bundle - m
Alb	Alb	Alb	Alb	Alb	Alb	Alb	Bundle - kg
700-55180	700-55185	700-55181	700-S50044	700-55187/88	700-S55182	700-55186	Product standard
Price gr. A615 (pce.)	Price gr. A547 (pce.)	Price gr. A645 (pce.)	Price gr. A601 (pce.)	Price gr. A487 (pce.)	Price gr. A723 (pair)	Price gr. A723 (pair)	neutral 10 (active
701-55180	701-55185	701-55181	701-S50044	701-55187/88	701-S55182	701-55186	white glossy) <input type="checkbox"/>
Price gr. A615 (pce.)	Price gr. A547 (pce.)	Price gr. A645 (pce.)	Price gr. A601 (pce.)	Price gr. A487 (pce.)	Price gr. A723 (pair)	Price gr. A723 (pair)	neutral 10 (active
552001-55180	552001-55185	552001-55181	552001-S50044	552001-55187/88	552001-S55182	552001-55186	white matt) <input type="checkbox"/>
Price gr. A618 (pce.)	Price gr. A556 (pce.)	Price gr. A654 (pce.)	Price gr. A608 (pce.)	Price gr. A489 (pce.)	Price gr. A731 (pair)	Price gr. A731 (pair)	active azure) <input type="checkbox"/>
552002-55180	552002-55185	552002-55181	552002-S50044	552002-55187/88	552002-S55182	552002-55186	light azure) <input type="checkbox"/>
Price gr. A618 (pce.)	Price gr. A556 (pce.)	Price gr. A654 (pce.)	Price gr. A608 (pce.)	Price gr. A489 (pce.)	Price gr. A731 (pair)	Price gr. A731 (pair)	neutral 1
5716-55180⁴	5716-55185⁴	5716-55181⁴	5716-S50044⁴	5716-55187/88⁴	5716-S55182⁴	5716-55186⁴	(deep black) <input type="checkbox"/>
Price gr. A618 (pce.)	Price gr. A556 (pce.)	Price gr. A654 (pce.)	Price gr. A608 (pce.)	Price gr. A489 (pce.)	Price gr. A731 (pair)	Price gr. A731 (pair)	



The products shown on this page can also be produced in other colors of the series Chroma non-slip. We will be pleased to check the possibility of such a special production upon request.

¹ Also available with rounded front edge for areas provided for ladders.

² For the matching outlet valve "Silent W 2000", refer to page 86

³ Model 85161 also available with outlet Ø 100 mm (=model 551312)

⁴ For reasons of production, differences in color between special pieces and standard tiles can occur.

Conic cuts for the products shown on this page are possible upon request.
No pallet rebate is granted for the products shown on this page.

Wiesbaden Silent

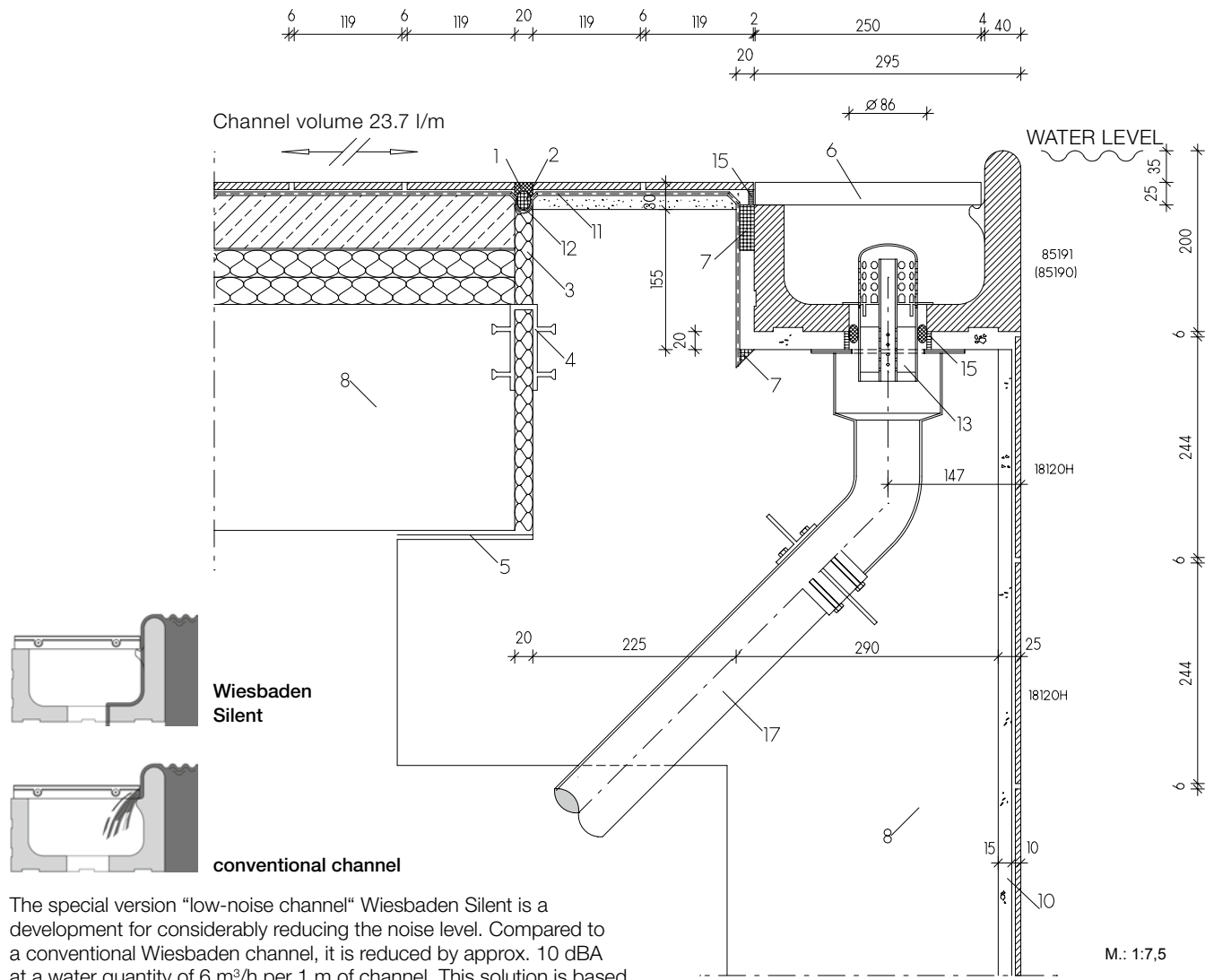

The special version "low-noise channel" Wiesbaden Silent is a development for considerably reducing the noise level. Compared to a conventional Wiesbaden channel, it is reduced by approx. 10 dBA at a water quantity of 6 m³/h per 1 m of channel. This solution is based on a complex combination of channel shape, arrangement of cover gratings and specially designed supporting strip for the gratings.

You will find the individual tiles and special pieces (= model numbers) of this system under:

- 18120H = Chroma tile (page 148 ff)
- 85160 = Overflow channel (page 39)
- 85161 = Overflow channel with outlet (page 39)
- Cover grating (page 84)
- Outlet valve Silent W 2000 (page 86)

Legend:

- 01 UW-Silicone
- 02 Closed-cell polyethylene foam round lace
- 03 Elastic water-resistant filling material
- 04 Joint band
- 05 Slide bearing
- 06 AGROB BUCHTAL plastic cover grating
- 07 Capillary barrier/grouting (reaction resin filler)

- 08 Waterproof concrete (according to DIN EN 206/DIN 1045/DAfStB WU Guideline)
- 09 Conventional thick-bed laying
- 10 Thin-bed laying on cement render (P III, CS IV without added lime)
- 11 Sealing layer
- 12 Sealing tape
- 13 Outlet valve „Silent W 2000“ of AGROB BUCHTAL
- 14 Air inlet pipe for outlet „Silent 100“
- 15 Epoxi for joints (for the projekt sector)
- 16 AGROB BUCHTAL section stoneware pipe
- 17 Casing for water inlet/outlet pipe and brazing collar

Large “Low-Noise Channel”

(only transverse gratings with a width of 250 mm can be used, see page 84)



Overflow channel ¹	“Half-size” overflow channel	Outlet (Ø 86 mm) ^{2/3}	Outlet (Ø 86 mm) ²	Terminal inlay left/ terminal inlay right	Internal corner (mitred pair, 4 parts)	External corner (mitred pair, 4 parts) Corner radius 30 mm	Art. no. 85190
85190	85195	85191	85193	85197/85198	S85192	85196	Model number
244 x 295 x 200/140	119 x 295 x 200/140	244 x 295 x 200/140	119 x 295 x 200/140	dim. as channel	(2x)414/119x295x200/140	(2x) 486 x 295 x 200/140	Nom. dim. - cm
4.000	8.000						Work size mm
10.400/pieces	5.100/pieces	10.100/pieces	4.800/pieces	0.300/pieces	20.800/pair	30.400/pair	m - pieces
1 pieces	2 pieces	1 piece	2 pieces		1 pair	1 pair	Pce./pair - kg
0.250	0.250						Bundle - pce./pair
10.400	10.200	10.100	9.600		20.800	30.400	Bundle - m
Alb	Alb	Alb	Alb	Alb	Alb	Alb	Bundle - kg
700-85190	700-85195	700-85191	700-85193	700-85197/98	700-S85192	700-85196	Product standard
Price gr. A715 (pce.)	Price gr. A638 (pce.)	Price gr. A734 (pce.)	Price gr. A689 (pce.)	Price gr. A539 (pce.)	Price gr. A814 (pair)	Price gr. A814 (pair)	neutral 10 (active white glossy) <input type="checkbox"/>
701-85190	701-85195	701-85191	701-85193	701-85197/98	701-S85192	701-85196	neutral 10 (active white matt) <input type="checkbox"/>
Price gr. A715 (pce.)	Price gr. A638 (pce.)	Price gr. A734 (pce.)	Price gr. A689 (pce.)	Price gr. A539 (pce.)	Price gr. A814 (pair)	Price gr. A814 (pair)	
552001-85190	552001-85195	552001-85191	552001-85193	552001-85197/98	552001-S85192	552001-85196	active azure <input type="checkbox"/>
Price gr. A716 (pce.)	Price gr. A645 (pce.)	Price gr. A741 (pce.)	Price gr. A698 (pce.)	Price gr. A545 (pce.)	Price gr. A816 (pair)	Price gr. A816 (pair)	
552002-85190	552002-85195	552002-85191	552002-85193	552002-85197/98	552002-S85192	552002-85196	light azure <input type="checkbox"/>
Price gr. A716 (pce.)	Price gr. A645 (pce.)	Price gr. A741 (pce.)	Price gr. A698 (pce.)	Price gr. A545 (pce.)	Price gr. A816 (pair)	Price gr. A816 (pair)	
5716-85190⁴	5716-85195⁴	5716-85191⁴	5716-85193⁴	5716-85197/98⁴	5716-S85192⁴	5716-85196⁴	neutral 1
Price gr. A716 (pce.)	Price gr. A645 (pce.)	Price gr. A741 (pce.)	Price gr. A698 (pce.)	Price gr. A545 (pce.)	Price gr. A816 (pair)	Price gr. A816 (pair)	(deep black) <input type="checkbox"/>



Small “Low-Noise Channel”

(only transverse gratings with a width of 191 mm can be used, see page 84)

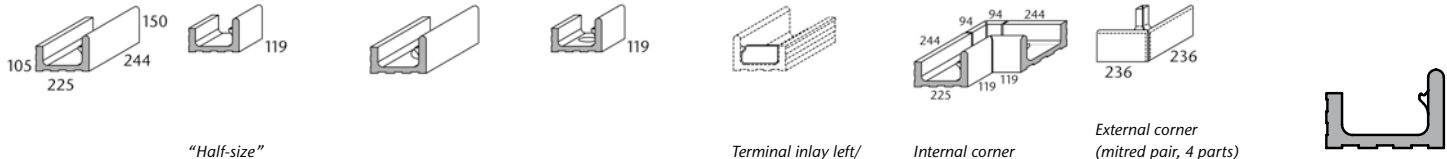

Overflow channel	“Half-size” overflow channel	Outlet (Ø 86 mm) ²	Outlet (Ø 86 mm) ²	Terminal inlay left/ terminal inlay right	Internal corner (mitred pair, 4 parts)	External corner (mitred pair, 4 parts) Corner radius 30 mm	Art. no. 85180
85180	85185	85181	85183	85187/85188	S85182	85186	Model number
244 x 225 x 150/105	119 x 225 x 150/105	244 x 225 x 150/105	119 x 225 x 150/105	dim. as channel	(2x)344/119x225x150/105	(2x) 236 x 225 x 150/105	Nom. dim. - cm
4.000	8.000						Work size mm
7.000/pieces	3.430/pieces	6.600/pieces	3.100/pieces	0.200/pieces	11.800/pair	8.300/pair	m - pieces
1 piece	2 pieces	1 piece	2 pieces		1 pair	1 pair	Pce./pair - kg
0.250	0.250						Bundle - pce./pair
7.000	6.860	6.600	6.200		11.800	8.300	Bundle - m
Alb	Alb	Alb	Alb	Alb	Alb	Alb	Bundle - kg
700-85180	700-85185	700-85181	700-85183	700-85187/88	700-S85182	700-85186	Product standard
Price gr. A649 (pce.)	Price gr. A581 (pce.)	Price gr. A683 (pce.)	Price gr. A638 (pce.)	Price gr. A511 (pce.)	Price gr. A757 (pair)	Price gr. A757 (pair)	neutral 10 (active white glossy) <input type="checkbox"/>
701-85180	701-85185	701-85181	701-85183	701-85187/88	701-S85182	701-85186	neutral 10 (active white matt) <input type="checkbox"/>
Price gr. A649 (pce.)	Price gr. A581 (pce.)	Price gr. A683 (pce.)	Price gr. A638 (pce.)	Price gr. A511 (pce.)	Price gr. A757 (pair)	Price gr. A757 (pair)	
552001-85180	552001-85185	552001-85181	552001-85183	552001-85187/88	552001-S85182	552001-85186	active azure <input type="checkbox"/>
Price gr. A654 (pce.)	Price gr. A587 (pce.)	Price gr. A698 (pce.)	Price gr. A645 (pce.)	Price gr. A514 (pce.)	Price gr. A766 (pair)	Price gr. A766 (pair)	
552002-85180	552002-85185	552002-85181	552002-85183	552002-85187/88	552002-S85182	552002-85186	light azure <input type="checkbox"/>
Price gr. A654 (pce.)	Price gr. A587 (pce.)	Price gr. A698 (pce.)	Price gr. A645 (pce.)	Price gr. A514 (pce.)	Price gr. A766 (pair)	Price gr. A766 (pair)	
5716-85180⁴	5716-85185⁴	5716-85181⁴	5716-85183⁴	5716-85187/88⁴	5716-S85182⁴	5716-85186⁴	neutral 1
Price gr. A654 (pce.)	Price gr. A587 (pce.)	Price gr. A698 (pce.)	Price gr. A645 (pce.)	Price gr. A514 (pce.)	Price gr. A766 (pair)	Price gr. A766 (pair)	(deep black) <input type="checkbox"/>



¹ Also available with rounded front edge for areas provided for ladders.

² For the matching outlet valve “Silent W 2000”, refer to page 86

³ Model 85191 also available with outlet Ø 100 mm. (= model S51325)

⁴ For reasons of production, differences in color between special pieces and standard tiles can occur.

Conic cuts for the products shown on this page are possible upon request.
No pallet rebate is granted for the products shown on this page.

 The products shown on this page can also be produced in other colors of the series Chroma non-slip. We will be pleased to check the possibility of such a special production upon request.



Large Channel (also available as low-noise channel Wiesbaden Silent = model 95190 upon request)
(Cover grating width 250 mm, see page 84)

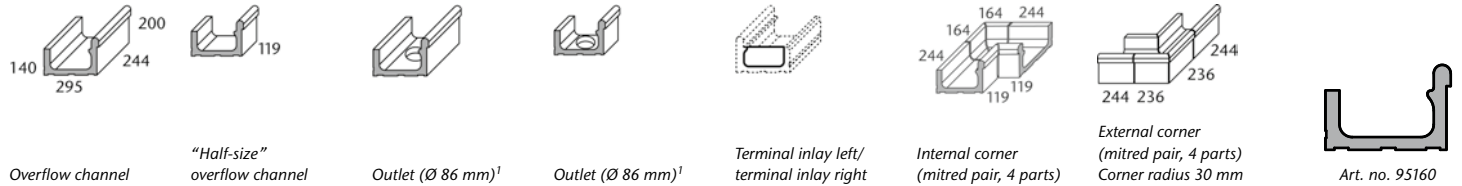

Overflow channel	"Half-size" overflow channel	Outlet (Ø 86 mm) ¹	Outlet (Ø 86 mm) ¹	Terminal inlay left/ terminal inlay right	Internal corner (mitred pair, 4 parts)	External corner (mitred pair, 4 parts) Corner radius 30 mm	Art. no. 95160
95160	95165	95161	95163	85167/85168	S95162	95166	Model number
244 x 295 x 200/140	119 x 295 x 200/140	244 x 295 x 200/140	119 x 295 x 200/140	dim. as channel	(2x)414/119x295x200/140	(2x) 486 x 295 x 200/140	Nom. dim. - cm
4.000	8.000						Work size mm
9.800/pieces	4.900/pieces	9.500/pieces	4.750/pieces	0.300/pieces	20.200/pair	29.200/pair	m - pieces
1 piece	2 pieces	1 piece	2 pieces		1 pair	1 pair	Pce./pair - kg
0.250	0.250						Bundle - pce./pair
9.800	9.800	9.500	9.500		20.200	29.200	Bundle - m
Alb	Alb	Alb	Alb	Alb	Alb	Alb	Bundle - kg
700-95160	700-95165	700-95161	700-95163	700-85167/68	700-S95162	700-95166	Product standard
Price gr. A663 (pce.)	Price gr. A593 (pce.)	Price gr. A683 (pce.)	Price gr. A638 (pce.)	Price gr. A484 (pce.)	Price gr. A799 (pair)	Price gr. A799 (pair)	neutral 10 (active
701-95160	701-95165	701-95161	701-95163	701-85167/68	701-S95162	701-95166	white glossy) <input type="checkbox"/>
Price gr. A663 (pce.)	Price gr. A593 (pce.)	Price gr. A683 (pce.)	Price gr. A638 (pce.)	Price gr. A484 (pce.)	Price gr. A799 (pair)	Price gr. A799 (pair)	neutral 10 (active
552001-95160	552001-95165	552001-95161	552001-95163	552001-85167/68	552001-S95162	552001-95166	white matt) <input type="checkbox"/>
Price gr. A668 (pce.)	Price gr. A600 (pce.)	Price gr. A698 (pce.)	Price gr. A645 (pce.)	Price gr. A489 (pce.)	Price gr. A804 (pair)	Price gr. A804 (pair)	active azure <input type="checkbox"/>
552002-95160	552002-95165	552002-95161	552002-95163	552002-85167/68	552002-S95162	552002-95166	light azure <input type="checkbox"/>
Price gr. A668 (pce.)	Price gr. A600 (pce.)	Price gr. A698 (pce.)	Price gr. A645 (pce.)	Price gr. A489 (pce.)	Price gr. A804 (pair)	Price gr. A804 (pair)	neutral 1
5716-95160³	5716-95165³	5716-95161³	5716-95163³	5716-85167/68³	5716-S95162³	5716-95166³	neutral 1
Price gr. A668 (pce.)	Price gr. A600 (pce.)	Price gr. A698 (pce.)	Price gr. A645 (pce.)	Price gr. A489 (pce.)	Price gr. A804 (pair)	Price gr. A804 (pair)	(deep black) <input type="checkbox"/>



Small Channel (also available as low-noise channel Wiesbaden Silent = model 96180 upon request)
(Cover grating width 191 mm, see page 84)

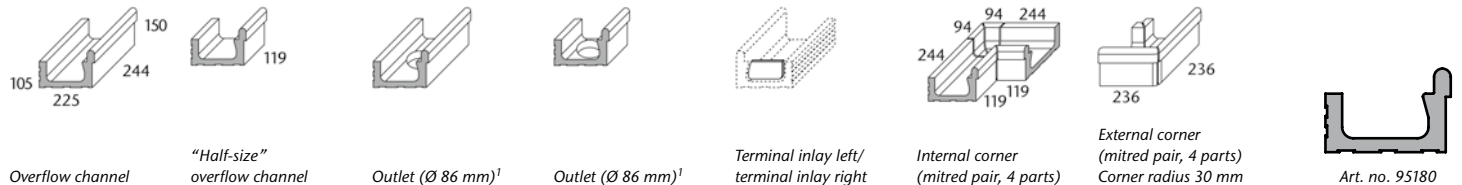

Overflow channel	"Half-size" overflow channel	Outlet (Ø 86 mm) ¹	Outlet (Ø 86 mm) ¹	Terminal inlay left/ terminal inlay right	Internal corner (mitred pair, 4 parts)	External corner (mitred pair, 4 parts) Corner radius 30 mm	Art. no. 95180
95180	95185	95181	95183	55187/55188	S95182	95186	Model number
244 x 225 x 150/105	119 x 225 x 150/105	244 x 225 x 150/105	119 x 225 x 150/105	dim. as channel	(2x)344/119x225x150/105	(2x) 236 x 225 x 150/105	Nom. dim. - cm
4.000	8.000						Work size mm
7.000/pieces	3.430/pieces	6.600/pieces	3.100/pieces	0.200/pieces	11.800/pair	8.300/pair	m - pieces
1 piece	2 pieces	1 piece	2 pieces		1 pair	1 pair	Pce./pair - kg
0.250	0.250						Bundle - pce./pair
7.000	6.860	6.600	6.200		11.800	8.300	Bundle - m
Alb	Alb	Alb	Alb	Alb	Alb	Alb	Bundle - kg
700-95180	700-95185	700-95181	700-95183	700-55187/88	700-S95182	700-95186	Product standard
Price gr. A625 (pce.)	Price gr. A560 (pce.)	Price gr. A663 (pce.)	Price gr. A615 (pce.)	Price gr. A487 (pce.)	Price gr. A734 (pair)	Price gr. A734 (pair)	neutral 10 (active
701-95180	701-95185	701-95181	701-95183	701-55187/88	701-S95182	701-95186	white glossy) <input type="checkbox"/>
Price gr. A625 (pce.)	Price gr. A560 (pce.)	Price gr. A663 (pce.)	Price gr. A615 (pce.)	Price gr. A487 (pce.)	Price gr. A734 (pair)	Price gr. A734 (pair)	neutral 10 (active
552001-95180	552001-95185	552001-95181	552001-95183	552001-55187/88	552001-S95182	552001-95186	white matt) <input type="checkbox"/>
Price gr. A629 (pce.)	Price gr. A573 (pce.)	Price gr. A668 (pce.)	Price gr. A618 (pce.)	Price gr. A489 (pce.)	Price gr. A742 (pair)	Price gr. A742 (pair)	active azure <input type="checkbox"/>
552002-95180	552002-95185	552002-95181	552002-95183	552002-55187/88	552002-S95182	552002-95186	light azure <input type="checkbox"/>
Price gr. A629 (pce.)	Price gr. A573 (pce.)	Price gr. A668 (pce.)	Price gr. A618 (pce.)	Price gr. A489 (pce.)	Price gr. A742 (pair)	Price gr. A742 (pair)	neutral 1
5716-95180³	5716-95185³	5716-95181³	5716-95183³	5716-55187/88³	5716-S95182³	5716-95186³	neutral 1
Price gr. A629 (pce.)	Price gr. A573 (pce.)	Price gr. A668 (pce.)	Price gr. A618 (pce.)	Price gr. A489 (pce.)	Price gr. A742 (pair)	Price gr. A742 (pair)	(deep black) <input type="checkbox"/>

¹ For the matching outlet valve "Silent W 2000", refer to page 86

² Matching mosaic: see series Plural, Fresh

³ For reasons of production, differences in color between special pieces and standard tiles can occur.

Conic cuts for the products shown on this page are possible upon request.
No pallet rebate is granted for the products shown on this page.

 The products shown on this page can also be produced in other colors of the series Chroma non-slip. We will be pleased to check the possibility of such a special production upon request.



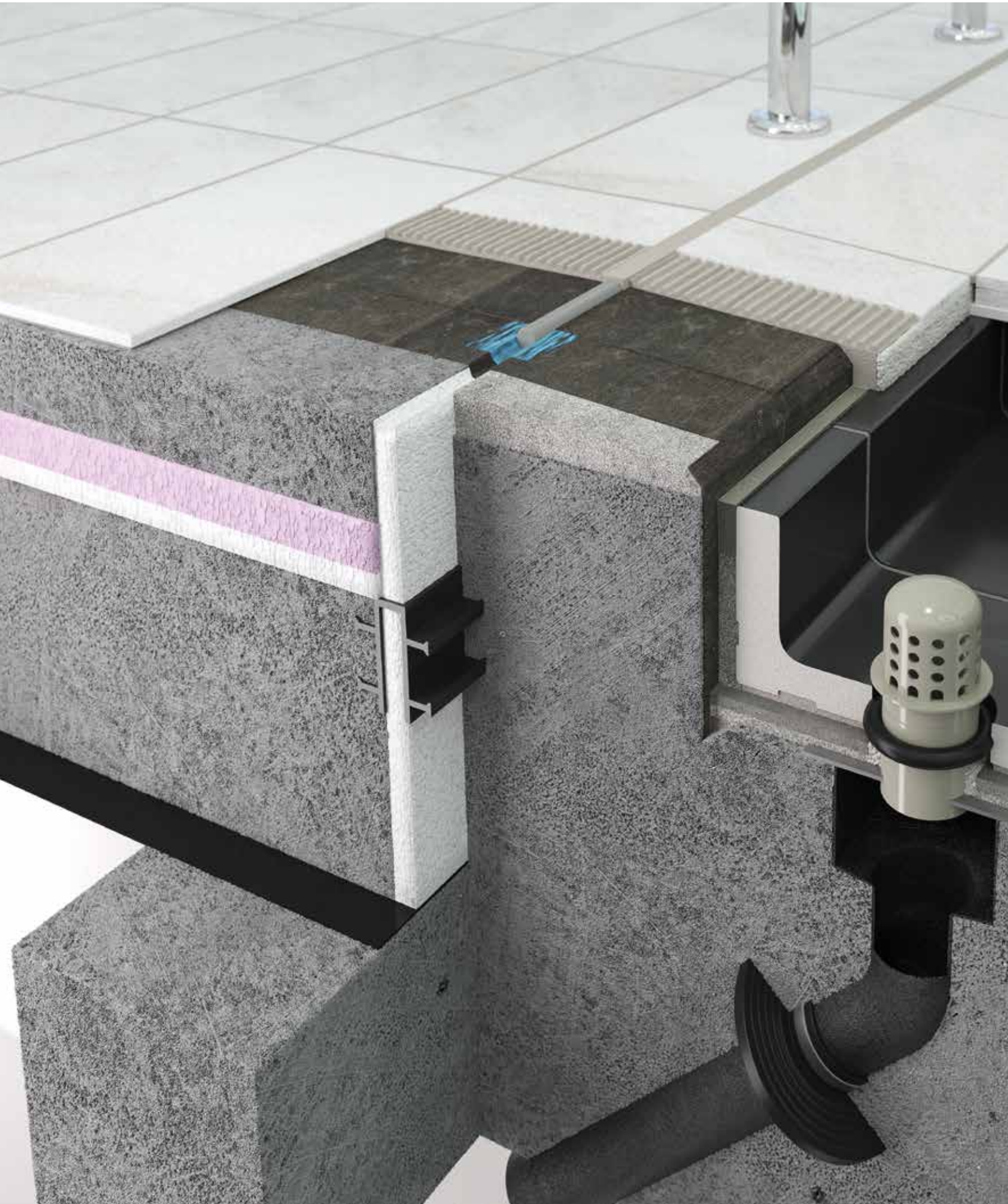



With a clear edge

The pool edge system Wiesbaden Stil is an elegant variation of the classic: the large overflow channel with handhold-piece is covered with a ceramic channel cover. Wiesbaden Stil is also available with mosaic recess on request. The ceramic channel cover enables a uniform design of the pool edge in the case of private and smaller hotel pools. The cover is easy to lay thanks to plug-in connections. The ceramic channel cover is slip-resistant, very robust and, on request and after a check, available in different formats and partly also for free shapes. Water flow rate: free cross-section of 245 cm²/m in case of standard hole pattern.

Wiesbaden Stil

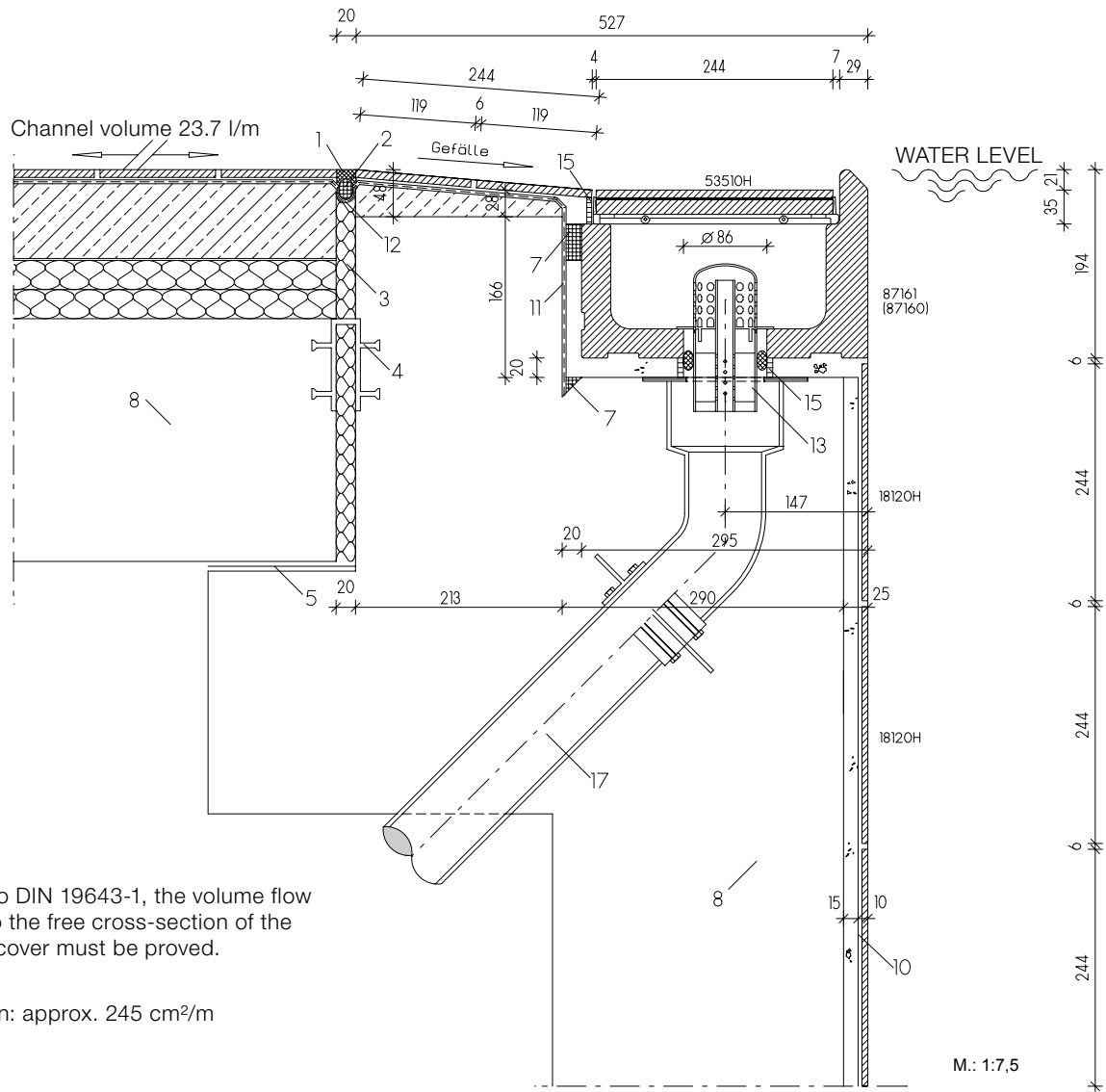

Note: according to DIN 19643-1, the volume flow rates in relation to the free cross-section of the ceramic channel cover must be proved.

Free cross-section: approx. 245 cm²/m

You will find the individual tiles and special pieces (= model numbers) of this system under:

- 18120H = Chroma tile (page 148 ff)
- 85160 = Overflow channel (page 45)
- 85161 = Overflow channel with outlet (page 45)
- 53510H = Ceramic channel cover (page 80)
- Outlet valve Silent W 2000 (page 86)

Legend:

- 01 UW-Silicone
- 02 Closed-cell polyethylene foam round lace
- 03 Elastic water-resistant filling material
- 04 Joint band
- 05 Slide bearing
- 06 AGROB BUCHTAL plastic cover grating
- 07 Capillary barrier/grouting (reaction resin filler)

- 08 Waterproof concrete (according to DIN EN 206/DIN 1045/DAfStB WU Guideline)
- 09 Conventional thick-bed laying
- 10 Thin-bed laying on cement render (P III, CS IV without added lime)
- 11 Sealing layer
- 12 Sealing tape
- 13 Outlet valve „Silent W 2000“ of AGROB BUCHTAL
- 14 Air inlet pipe for outlet „Silent 100“
- 15 Epoxi for joints (for the projekt sector)
- 16 AGROB BUCHTAL section stoneware pipe
- 17 Casing for water inlet/outlet pipe and brazing collar

Large Channel (also available with mosaic recess = model 97160 upon request³)
(ceramic channel cover, width 250 mm)



Overflow channel ¹	"Half-size" overflow channel	Outlet (Ø 86 mm) ²	Outlet (Ø 86 mm) ²	Terminal inlay left/terminal inlay right	Internal corner (mitred pair, 4 parts)	External corner (mitred pair, 4 parts) Corner radius 30 mm	Art. Nr. 87160
87160	87165	87161	87163	87167/87168	S87162	87166	Model number
244 x 295 x 138/194	119 x 295 x 138/194	244 x 295 x 138/194	119 x 295 x 138/194	dim. as channel	(2x)414/119x295x138/194	(2x) 486 x 295 x 138/194	Nom. dim. - cm
4.000	8.000						Work size mm
10.200/pieces	5.100/pieces	10.000/pieces	4.700/pieces	0.300/pieces	20.500/pair	30.000/pair	m - pieces
1 piece	2 pieces	1 piece	2 pieces		1 pair	1 pair	Pce./pair - kg
0.250	0.250						Bundle - pce./pair
10.200	10.200	10.000	9.400		20.500	30.000	Bundle - m
Alb	Alb	Alb	Alb	Alb	Alb	Alb	Bundle - kg
700-87160	700-87165	700-87161	700-87163	700-87167/68	700-S87162	700-87166	Product standard
Price gr. A649 (pce.)	Price gr. A581 (pce.)	Price gr. A668 (pce.)	Price gr. A625 (pce.)	Price gr. A484 (pce.)	Price gr. A792 (pair)	Price gr. A792 (pair)	neutral 10 (active white glossy) <input type="checkbox"/>
701-87160	701-87165	701-87161	701-87163	701-87167/68	701-S87162	701-87166	neutral 10 (active white matt) <input type="checkbox"/>
Price gr. A649 (pce.)	Price gr. A581 (pce.)	Price gr. A668 (pce.)	Price gr. A625 (pce.)	Price gr. A484 (pce.)	Price gr. A792 (pair)	Price gr. A792 (pair)	active azure <input type="checkbox"/>
552001-87160	552001-87165	552001-87161	552001-87163	552001-87167/68	552001-S87162	552001-87166	light azure <input type="checkbox"/>
Price gr. A654 (pce.)	Price gr. A587 (pce.)	Price gr. A683 (pce.)	Price gr. A629 (pce.)	Price gr. A489 (pce.)	Price gr. A800 (pair)	Price gr. A800 (pair)	neutral 1 (deep black) <input type="checkbox"/>
552002-87160	552002-87165	552002-87161	552002-87163	552002-87167/68	552002-S87162	552002-87166	
Price gr. A654 (pce.)	Price gr. A587 (pce.)	Price gr. A683 (pce.)	Price gr. A629 (pce.)	Price gr. A489 (pce.)	Price gr. A800 (pair)	Price gr. A800 (pair)	
5716-87160⁴	5716-87165⁴	5716-87161⁴	5716-87163⁴	5716-87167/68⁴	5716-S87162⁴	5716-87166⁴	
Price gr. A654 (pce.)	Price gr. A587 (pce.)	Price gr. A683 (pce.)	Price gr. A629 (pce.)	Price gr. A489 (pce.)	Price gr. A800 (pair)	Price gr. A800 (pair)	

¹ Also available with rounded front edge for areas provided for ladders.

² For the matching outlet valve "Silent W 2000", refer to page 86

³ Matching mosaic: see series Plural S. 183 ff

⁴ For reasons of production, differences in color between special pieces and standard tiles can occur.

Conic cuts for the products shown on this page are possible upon request.
No pallet rebate is granted for the products shown on this page.



The products shown on this page can also be produced in other colors of the series Chroma non-slip. We will be pleased to check the possibility of such a special production upon request.





Specialist for attractions

The version with decreased water level permits an additional "accumulation height" which is desired above all for the use of water attractions. Thus, this system is optimally suitable for slide landing pools, for example.

Different channel cross-sections and dimensions extend the application possibilities, for example, in case of elevated pool walls in flow channels. Among other things, the outlet valve Silent W 2000 is available as an accessory.

Wiesbaden with decreased water level

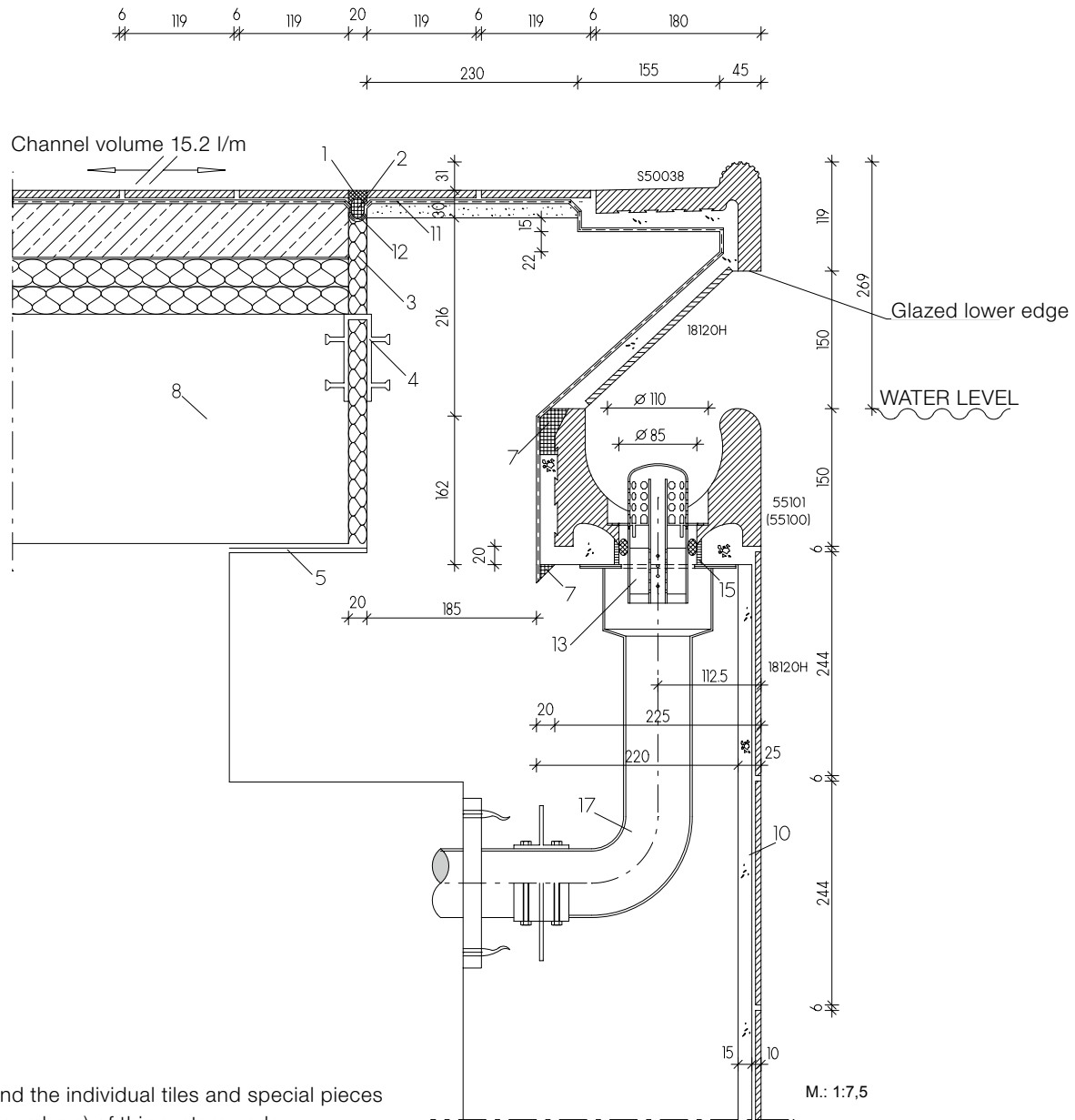

You will find the individual tiles and special pieces (= model numbers) of this system under:

- 18120H = Chroma tile (page 148 ff)
- 55100 = Overflow channel (page 49)
- 55101 = Overflow channel with outlet (page 49)
- S50038 = Pool edging tile (like 55450 with glazed lower edge, page 92)
- Outlet valve Silent W 2000 (page 86)

Legend:

- 01 UW-Silicone
- 02 Closed-cell polyethylene foam round lace
- 03 Elastic water-resistant filling material
- 04 Joint band
- 05 Slide bearing
- 06 AGROB BUCHTAL plastic cover grating
- 07 Capillary barrier/grouting (reaction resin filler)

- 08 Waterproof concrete (according to DIN EN 206/DIN 1045/DAfStB WU Guideline)
- 09 Conventional thick-bed laying
- 10 Thin-bed laying on cement render (P III, CS IV without added lime)
- 11 Sealing layer
- 12 Sealing tape
- 13 Outlet valve „Silent W 2000“ of AGROB BUCHTAL
- 14 Air inlet pipe for outlet „Silent 100“
- 15 Epoxi for joints (for the projekt sector)
- 16 AGROB BUCHTAL section stoneware pipe
- 17 Casing for water inlet/outlet pipe and brazing collar

Large Channel (also available with mosaic recess = model 95100 upon request)
(without cover grating support)

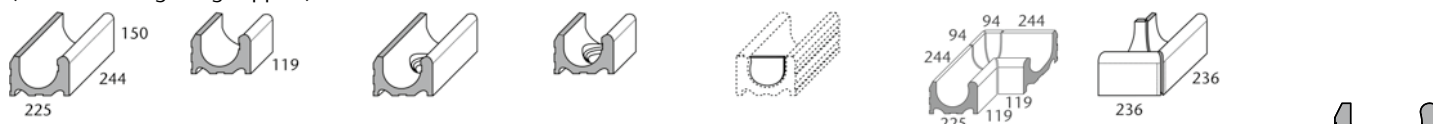

Overflow channel	"Half-size" overflow channel	Outlet (Ø 86 mm) ¹	Outlet (Ø 86 mm) ¹	Terminal inlay left/terminal inlay right	Internal corner (mitred pair, 4 parts)	External corner (mitred pair, 4 parts) Corner radius 30 mm	Art. no. 55100
55100	55105	55101	S50065	55107/55108	S55102	55106	Model number
244 x 225 x 150	119 x 225 x 150	244 x 225 x 150	119 x 225 x 150	dim. as channel	(2x)344/119 x 225 x 150	(2x) 236 x 225 x 150	Nom. dim. - cm
4.000	8.000						Work size mm
8.600/pieces	4.200/pieces	8.100/pieces	3.800/pieces	0.200/pieces	10.000/pair	9.600/pair	m - pieces
1 piece	2 pieces	1 piece	2 pieces		1 pair	1 pair	Pce./pair - kg
0.250	0.250						Bundle - pce./pair
8.600	8.400	8.100	7.600		16.000	9.600	Bundle - m
Alb	Alb	Alb	Alb	Alb	Alb	Alb	Bundle - kg
700-55100	700-55105	700-55101	700-S50065	700-55107/08	700-S55102	700-55106	Product standard
Price gr. A601 (pce.)	Price gr. A545 (pce.)	Price gr. A654 (pce.)	Price gr. A638 (pce.)	Price gr. A489 (pce.)	Price gr. A716 (pair)	Price gr. A716 (pair)	neutral 10 (active white glossy) <input type="checkbox"/>
701-55100	701-55105	701-55101	701-S50065	701-55107/08	701-S55102	701-55106	neutral 10 (active white matt) <input type="checkbox"/>
Price gr. A601 (pce.)	Price gr. A545 (pce.)	Price gr. A654 (pce.)	Price gr. A638 (pce.)	Price gr. A489 (pce.)	Price gr. A716 (pair)	Price gr. A716 (pair)	active azure <input type="checkbox"/>
552001-55100	552001-55105	552001-55101	552001-S50065	552001-55107/08	552001-S55102	552001-55106	light azure <input type="checkbox"/>
Price gr. A608 (pce.)	Price gr. A547 (pce.)	Price gr. A663 (pce.)	Price gr. A645 (pce.)	Price gr. A506 (pce.)	Price gr. A723 (pair)	Price gr. A723 (pair)	neutral 1 <input type="checkbox"/>
552002-55100	552002-55105	552002-55101	552002-S50065	552002-55107/08	552002-S55102	552002-55106	(deep black) <input type="checkbox"/>
Price gr. A608 (pce.)	Price gr. A547 (pce.)	Price gr. A663 (pce.)	Price gr. A645 (pce.)	Price gr. A506 (pce.)	Price gr. A723 (pair)	Price gr. A723 (pair)	
5716-55100²	5716-55105²	5716-55101²	5716-S50065²	5716-55107/08²	5716-S55102²	5716-55106²	
Price gr. A608 (pce.)	Price gr. A547 (pce.)	Price gr. A663 (pce.)	Price gr. A645 (pce.)	Price gr. A506 (pce.)	Price gr. A723 (pair)	Price gr. A723 (pair)	



Small Channel
(without cover grating support)



Overflow channel	"Half-size" overflow channel	Outlet (Ø 75 mm) ¹	Outlet (Ø 75 mm) ¹	Terminal inlay left/terminal inlay right	Internal corner (mitred pair, 4 parts)	External corner (mitred pair, 4 parts) Corner radius 30 mm	Art. no. 55140
55140	55145	55141	55143	55147/55148	S55142	55146	Model number
244 x 150/160 x 100/130	119 x 150/160 x 100/130	244 x 150/160 x 100/130	119 x 150/160 x 100/130	dim. as channel	(2x)279/119x150/160x100/130	(2x) 236x150/160x100/130	Nom. dim. - cm
4.000	8.000						Work size mm
4.450/pieces	2.260/pieces	4.100/pieces	2.000/pieces	0.100/pieces	7.050/pair	6.300/pair	m - pieces
2 pieces	4 pieces	2 pieces	4 pieces		1 pair	1 pair	Pce./pair - kg
0.500	0.500						Bundle - pce./pair
8.900	9.040	8.200	8.000		7.050	6.300	Bundle - m
Alb	Alb	Alb	Alb	Alb	Alb	Alb	Bundle - kg
700-55140	700-55145	700-55141	700-55143	700-55147/48	700-S55142	700-55146	Product standard
Price gr. A600 (pce.)	Price gr. A533 (pce.)	Price gr. A636 (pce.)	Price gr. A593 (pce.)	Price gr. A487 (pce.)	Price gr. A716 (pair)	Price gr. A716 (pair)	neutral 10 (active white glossy) <input type="checkbox"/>
701-55140	701-55145	701-55141	701-55143	701-55147/48	701-S55142	701-55146	neutral 10 (active white matt) <input type="checkbox"/>
Price gr. A600 (pce.)	Price gr. A533 (pce.)	Price gr. A636 (pce.)	Price gr. A593 (pce.)	Price gr. A487 (pce.)	Price gr. A716 (pair)	Price gr. A716 (pair)	active azure <input type="checkbox"/>
552001-55140	552001-55145	552001-55141	552001-55143	552001-55147/48	552001-S55142	552001-55146	light azure <input type="checkbox"/>
Price gr. A604 (pce.)	Price gr. A539 (pce.)	Price gr. A638 (pce.)	Price gr. A601 (pce.)	Price gr. A489 (pce.)	Price gr. A723 (pair)	Price gr. A723 (pair)	neutral 1 <input type="checkbox"/>
552002-55140	552002-55145	552002-55141	552002-55143	552002-55147/48	552002-S55142	552002-55146	(deep black) <input type="checkbox"/>
Price gr. A604 (pce.)	Price gr. A539 (pce.)	Price gr. A638 (pce.)	Price gr. A601 (pce.)	Price gr. A489 (pce.)	Price gr. A723 (pair)	Price gr. A723 (pair)	
5716-55140²	5716-55145²	5716-55141²	5716-55143²	5716-55147/48²	5716-S55142²	5716-55146²	
Price gr. A604 (pce.)	Price gr. A539 (pce.)	Price gr. A638 (pce.)	Price gr. A601 (pce.)	Price gr. A489 (pce.)	Price gr. A723 (pair)	Price gr. A723 (pair)	

¹ For the matching outlet valve "Silent W 2000", refer to page 86

² For reasons of production, differences in color between special pieces and standard tiles can occur.

Conic cuts for the products shown on this page are possible upon request.
No pallet rebate is granted for the products shown on this page.

 The products shown on this page can also be produced in other colors of the series Chroma non-slip. We will be pleased to check the possibility of such a special production upon request.







In the version with small overflow channel without cover, Wiesbaden with decreased water level is primarily designed for the use in therapy facilities. In combination with an elevated pool edge, this results in a back-friendly effect for the staff, who can work with the patients without having to constantly adopt a stooped posture.

Therapy pool DRK-Krankenhaus (hospital), Langen-Debstedt, Germany / Architect: Westphal u. Partner Architekten
Series: Pool edge system Wiesbaden / Photo: Veit S. Müller



Wiesbaden, therapy pools

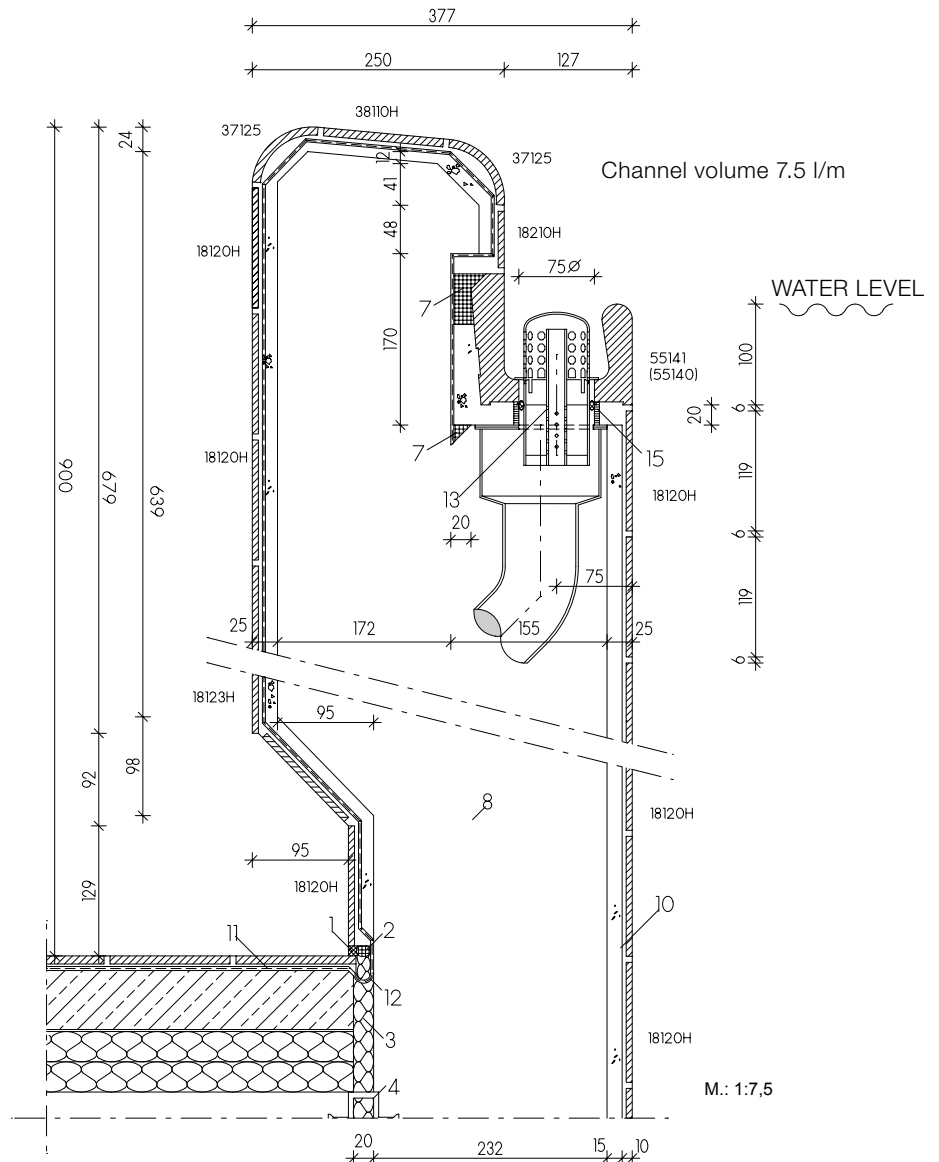

You will find the individual tiles and special pieces (= model numbers) of this system under:

- 18120H = Chroma tile (page 148 ff)
- 55140 = Overflow channel (page 49)
- 55141 = Overflow channel with outlet (page 49)
- 18210H = Chroma strip tile (page 148 ff)
- 37125 = Profiled edging (page 100)
- 38110H = Chroma non-slip tile (page 155 ff)
- 18123H = Chroma tile (page 149 ff)
- Outlet valve Silent W 2000 (page 86)

Legend:

- 01 UW-Silicone
- 02 Closed-cell polyethylene foam round lace
- 03 Elastic water-resistant filling material
- 04 Joint band
- 05 Slide bearing
- 06 AGROB BUCHTAL plastic cover grating
- 07 Capillary barrier/grouting (reaction resin filler)

- 08 Waterproof concrete (according to DIN EN 206/ DIN 1045/DAfStB WU Guideline)
- 09 Conventional thick-bed laying
- 10 Thin-bed laying on cement render (P III, CS IV without added lime)
- 11 Sealing layer
- 12 Sealing tape
- 13 Outlet valve „Silent W 2000“ of AGROB BUCHTAL
- 14 Air inlet pipe for outlet „Silent 100“
- 15 Epoxi for joints (for the projekt sector)
- 16 AGROB BUCHTAL section stoneware pipe
- 17 Casing for water inlet/outlet pipe and brazing collar





Sustainable innovation

Developed for Germany's first swimming pool satisfying the passive house requirements, the pool edge system Bamberg is convincing above all because of reduced water evaporation and a considerable decrease of the energy requirement. Additional advantages: elegant look without cover gratings and low noise level.

The versatile system shows its qualities in leisure and adventure pools just as well as in thermal, private and hotel pools. The large overflow channel with integrated handhold-piece makes cover gratings superfluous, directly adjoins the pool surround and thus creates a uniform overall picture. The profile of the overflow channel was developed in extensive, scientifically supervised tests.

Bamberg

While the splash water increases the evaporation rate in the case of conventional systems, the Bamberg Channel effects a considerable reduction thanks to its sophisticated design and thus makes an important contribution to energy saving: heat losses are reduced, the ventilation systems must circulate less air and thus consume less electricity. Bamberg offers additional possibilities for individual design by different colors for the handhold-piece and the channel, and special colors are also possible after a check.

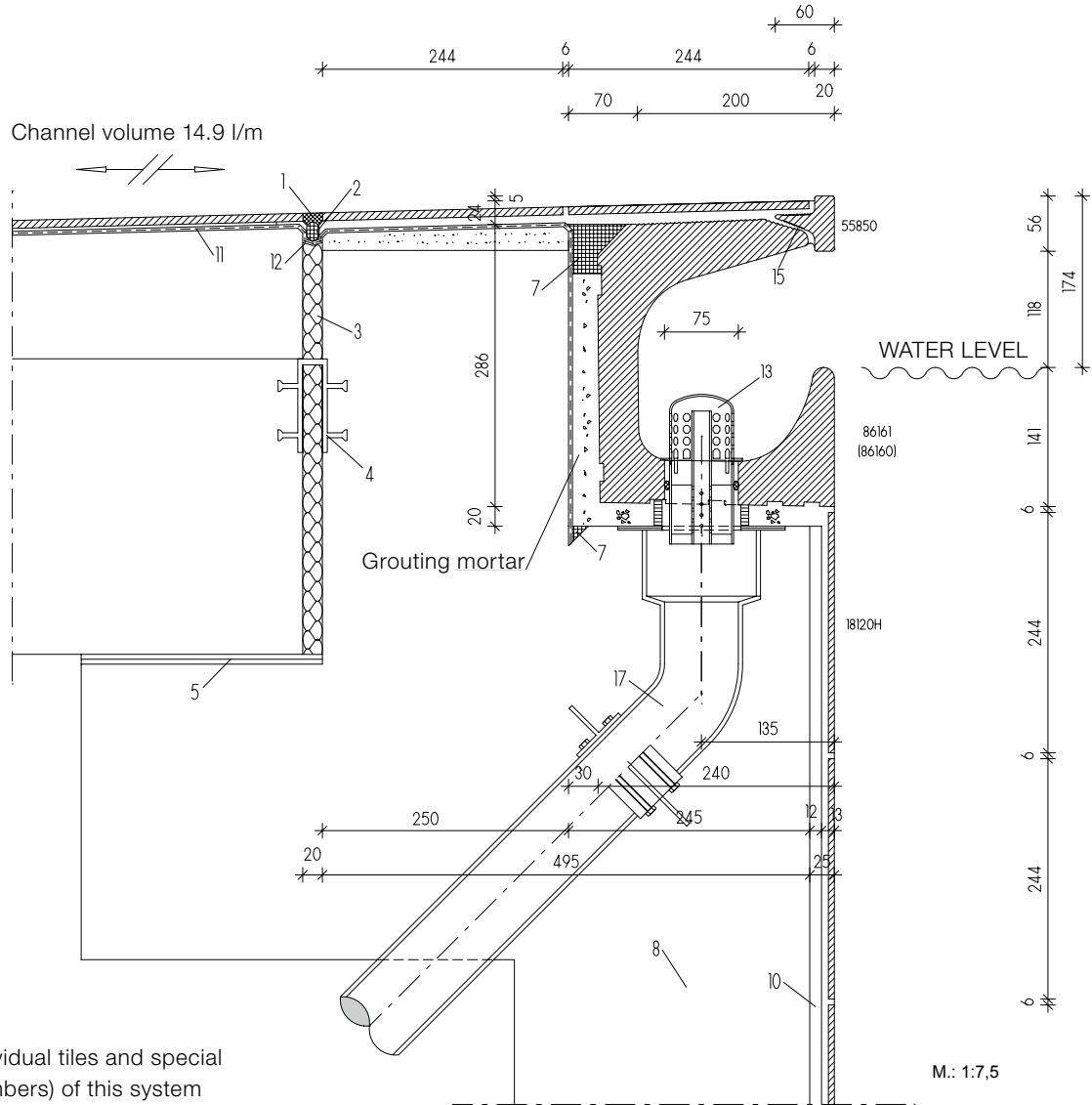

You will find the individual tiles and special pieces (= model numbers) of this system under:

- 18120H = Chroma tile (page 148 ff)
- 86160 = Overflow channel (page 57)
- 86161 = Overflow channel with outlet (Ø 75 mm) (page 57)
- 55850 = Pool edging tile (page 57)
- 55857/ = First piece left/right (page 57)
- 55858
- Outlet valve Silent W 2000 (page 86)

Legend:

- 01 UW-Silicone
- 02 Closed-cell polyethylene foam round lace
- 03 Elastic water-resistant filling material
- 04 Joint band
- 05 Slide bearing
- 06 AGROB BUCHTAL plastic cover grating
- 07 Capillary barrier/grouting (reaction resin filler)

- 08 Waterproof concrete (according to DIN EN 206/DIN 1045/DAfStB WU Guideline)
- 09 Conventional thick-bed laying
- 10 Thin-bed laying on cement render (P III, CS IV without added lime)
- 11 Sealing layer
- 12 Sealing tape
- 13 Outlet valve „Silent W 2000“ of AGROB BUCHTAL
- 14 Air inlet pipe for outlet „Silent 100“
- 15 Epoxi for joints (for the projekt sector)
- 16 AGROB BUCHTAL section stoneware pipe
- 17 Casing for water inlet/outlet pipe and brazing collar

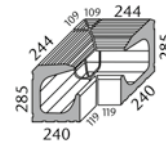
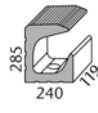
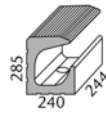
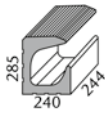

Overflow channel	"Half-size" overflow channel	Outlet (Ø 75 mm) ¹	Outlet (Ø 75 mm) ¹	Terminal inlay left/ terminal inlay right	Internal corner ³ (mitred pair, 4 parts)	Art. no. 86160
86160	86165	86161	86163	86167/86168	86162	Model number
244 x 240 x 285	119 x 240 x 285	244 x 240 x 285	119 x 240 x 285	dim. as channel	(2x) 359/119 x 240 x 285	Nom. dim. - cm
4.000	8.000					Work size mm
18.250/pieces	8.900/pieces	17.750/pieces	8.600/pieces	0.300/pieces	45.000/pair	m - pieces
1 piece	2 pieces	1 piece	2 pieces		1 pair	Pce./pair - kg
0.250	0.250					Bundle - pce./pair
18.250	17.800	17.750	17.200		45.000	Bundle - m
Alb	Alb	Alb	Alb	Alb	Alb	Bundle - kg
700-86160	700-86165	700-86161	700-86163	700-86167/68	700-86162	Product standard
Price gr. A716 (pce.)	Price gr. A654 (pce.)	Price gr. A742 (pce.)	Price gr. A702 (pce.)	Price gr. A547 (pce.)	Price gr. A804 (pair)	neutral 10 (active white glossy) <input type="checkbox"/>
701-86160	701-86165	701-86161	701-86163	701-86167/68	701-86162	neutral 10 (active white matt) <input type="checkbox"/>
Price gr. A716 (pce.)	Price gr. A654 (pce.)	Price gr. A742 (pce.)	Price gr. A702 (pce.)	Price gr. A547 (pce.)	Price gr. A804 (pair)	active azure <input type="checkbox"/>
552001-86160	552001-86165	552001-86161	552001-86163	552001-86167/68	552001-86162	light azure <input type="checkbox"/>
Price gr. A723 (pce.)	Price gr. A663 (pce.)	Price gr. A748 (pce.)	Price gr. A705 (pce.)	Price gr. A556 (pce.)	Price gr. A814 (pair)	neutral 1 (deep black) <input type="checkbox"/>
552002-86160	552002-86165	552002-86161	552002-86163	552002-86167/68	552002-86162	
Price gr. A723 (pce.)	Price gr. A663 (pce.)	Price gr. A748 (pce.)	Price gr. A705 (pce.)	Price gr. A556 (pce.)	Price gr. A814 (pair)	
5716-86160²	5716-86165²	5716-86161²	5716-86163²	5716-86167/68²	5716-86162²	
Price gr. A723 (pce.)	Price gr. A663 (pce.)	Price gr. A748 (pce.)	Price gr. A705 (pce.)	Price gr. A556 (pce.)	Price gr. A814 (pair)	



HANDHOLD-PIECE (T-PIECES)

Please note: use the XPS laying tool for the laying of the T-pieces



Accessory XPS laying tool	Pool edging tile	"Half-size" Pool edging tile	Internal corner (mitred pair)	External corner (mitred pair) Corner radius 30 mm	First piece left/right	Art. no. 55850
	55850	55855	55852	55856	55857/55858	Model number
	244 x 20/60 x 56	119 x 20/60 x 56	(2x) 119/175 x 20/60 x 56	(2x) 236/183 x 20/60 x 56	244 x 20/60 x 56	Nom. dim. - cm
	4.000	8.000				Work size mm
0.020/pieces	0.900/pieces	0.440/pieces	0.440/pair	0.800/pair	0.910/pieces	m - pieces
	18	36				Pce./pair - kg
	4.500	4.500				Bundle - pce./pair
	16.200	15.840				Bundle - m
	Alb	Alb	Alb	Alb	Alb	Bundle - kg
F-190	700-55850	700-55855	700-55852	700-55856	700-55857/58	Product standard
Price gr. A434 (pce.)	Price gr. A467 (pce.)	Price gr. A438 (pce.)	Price gr. A577 (pair)	Price gr. A587 (pair)	Price gr. A480 (pce.)	neutral 10 (active white glossy) <input type="checkbox"/>
F-190	701-55850	701-55855	701-55852	701-55856	701-55857/58	neutral 10 (active white matt) <input type="checkbox"/>
Price gr. A434 (pce.)	Price gr. A467 (pce.)	Price gr. A438 (pce.)	Price gr. A577 (pair)	Price gr. A587 (pair)	Price gr. A480 (pce.)	active azure <input type="checkbox"/>
F-190	552001-55850	552001-55855	552001-55852	552001-55856	552001-55857/58	light azure <input type="checkbox"/>
Price gr. A434 (pce.)	Price gr. A471 (pce.)	Price gr. A441 (pce.)	Price gr. A581 (pair)	Price gr. A593 (pair)	Price gr. A484 (pce.)	neutral 1 (deep black) <input type="checkbox"/>
F-190	552002-55850	552002-55855	552002-55852	552002-55856	552002-55857/58	
Price gr. A434 (pce.)	Price gr. A471 (pce.)	Price gr. A441 (pce.)	Price gr. A581 (pair)	Price gr. A593 (pair)	Price gr. A484 (pce.)	
F-190	5716-55850²	5716-55855²	5716-55852²	5716-55856²	5716-55857/58²	
Price gr. A434 (pce.)	Price gr. A471 (pce.)	Price gr. A441 (pce.)	Price gr. A581 (pair)	Price gr. A593 (pair)	Price gr. A484 (pce.)	

¹ For the matching outlet valve "Silent W 2000", refer to page 86

² For reasons of production, differences in color between special pieces and standard tiles can occur.

³ Please note: due to the shaping, external angles are not possible.

Conic cuts for the products shown on this page are possible upon request.
No pallet rebate is granted for the products shown on this page.

 The products shown on this page can also be produced in other colors of the series Chroma non-slip. We will be pleased to check the possibility of such a special production upon request.







Bathing pleasure with panoramic view

The characteristic feature of the pool edge system St. Moritz is the elevated pool edge. This results in advantages not only with regard to pool construction. The bathers enjoy the view from their elevated position compared to the conventional construction method.

The system with integrated handhold-piece is tailored to the requirements of leisure and adventure pools, but also proves its worth in private and hotel pools. In the case of this construction, overflowing water flows down the outer walls of the pool into the channel on the outside, which is covered by a plastic grating. Cost advantages result above all from the lower foundation depth for the pool.

Hotel aja, Garmisch-Partenkirchen, Germany / Architect: SMAP SEEGER MÜLLER Berlin (Germany) und Büro Korb, Hamburg (Germany)
Series: Quarzit / Photo: Fotodesign Peters



St. Moritz

With the system St. Moritz, any pool edge widths with different edge covers can be realized. However, the "elevated" pool is also attractive for the bathers: they have an unobstructed view of the surroundings and can communicate with people outside the pool almost at eye level.

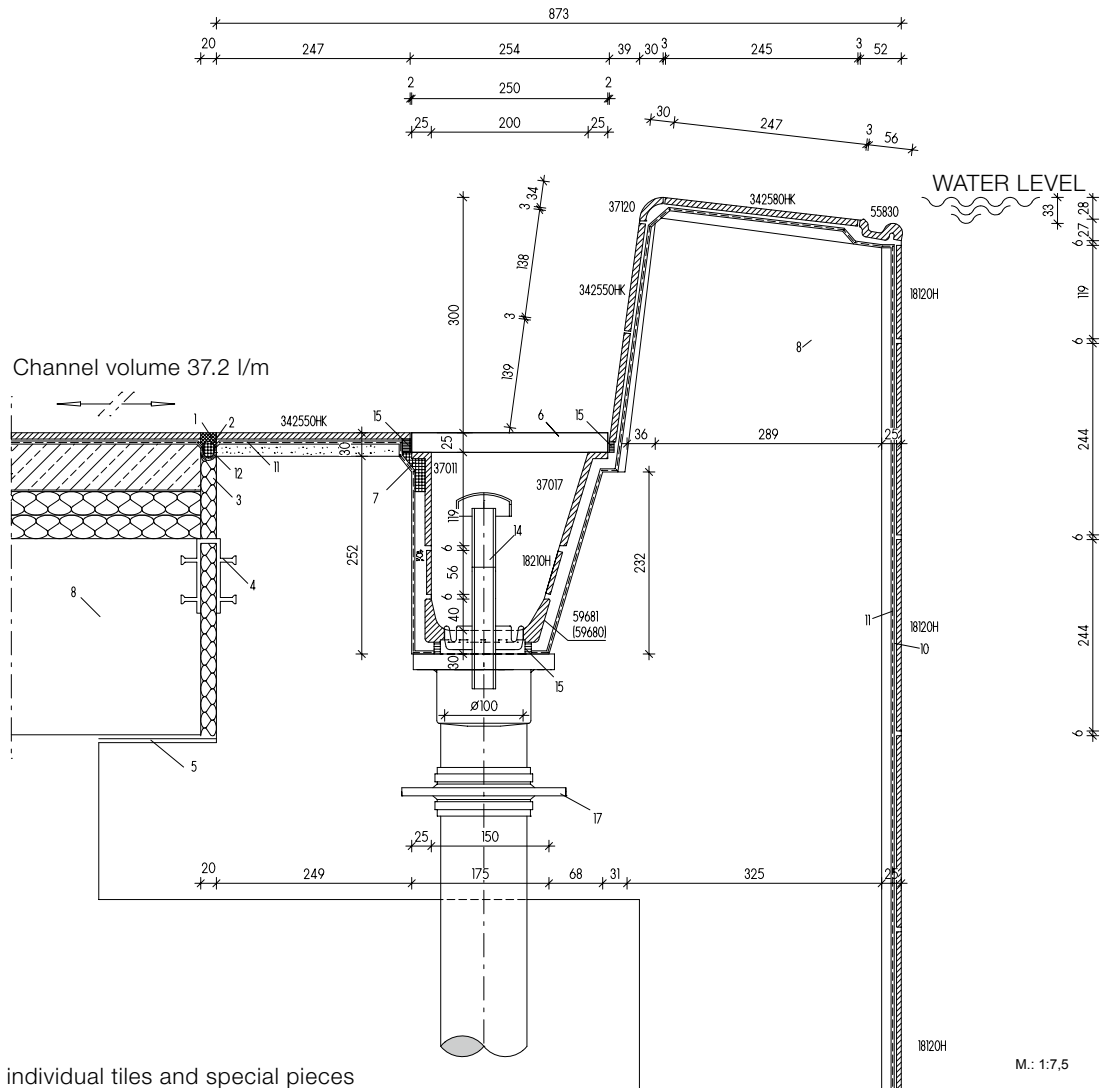

You will find the individual tiles and special pieces (= model numbers) of this system under:

- 18120H = Chroma tile (page 148 ff)
- 55830 = Handhold-piece (page 31)
- 342580HK = Quarzit grid profile tile (page 209)
- 37120 = Profiled edging (page 99)
- 342550HK = Quarzit tile (page 209)
- 37017 = Inclined shank-tile (page 113)
- 18210H = Chroma tile (page 148 ff)
- 37011 = Straight shank-tile (page 113)
- 59681 (59680) = Coved gutter tile (page 113)
- Outlet valve Silent 100 (page 86)
- Cover grating (page 84)

Legend:

- 01 UW-Silicone
- 02 Closed-cell polyethylene foam round lace
- 03 Elastic water-resistant filling material
- 04 Joint band

- 05 Slide bearing
- 06 AGROB BUCHTAL plastic cover grating
- 07 Capillary barrier/grouting (reaction resin filler)
- 08 Waterproof concrete (according to DIN EN 206/DIN 1045/DAfStB WU Guideline)
- 09 Conventional thick-bed laying
- 10 Thin-bed laying on cement render (P III, CS IV without added lime)
- 11 Sealing layer
- 12 Sealing tape
- 13 Outlet valve „Silent W 2000“ of AGROB BUCHTAL
- 14 Air inlet pipe for outlet „Silent 100“
- 15 Epoxi for joints (for the projekt sector)
- 16 AGROB BUCHTAL section stoneware pipe
- 17 Casing for water inlet/outlet pipe and brazing collar





Flexible alternative

In the case of this system, the elevated overflow edge is designed as a handhold. The covered channel, which collects the overflowing water, is located – viewed from the pool – directly behind it and ensures a smooth, low-noise water inflow thanks to its rounded shape.

Due to its design, the system Berlin is suitable for use in leisure and adventure pools, among others. With the overflow channel directly adjacent to the pool it can be considered as an alternative to the pool edge system Wiesbaden, but offers the advantage of greater flexibility: the width and depth of the channel are variable in the case of the pool edge system Berlin and can be exactly adapted to the local conditions.

Indoor swimming pool, Münster-Kinderhaus, Germany / Architect: Janßen Bär Partnerschaft
Series: Pool edge system Berlin, Chroma, Unique, Valley / Photo: Stephan Brendgen



Berlin

Plastic channel covers are available as accessories. The outlet valve Silent 100 from AGROB BUCHTAL, which is also suitable for combination with the system Berlin, helps to effectively reduce the noise level in the pool.

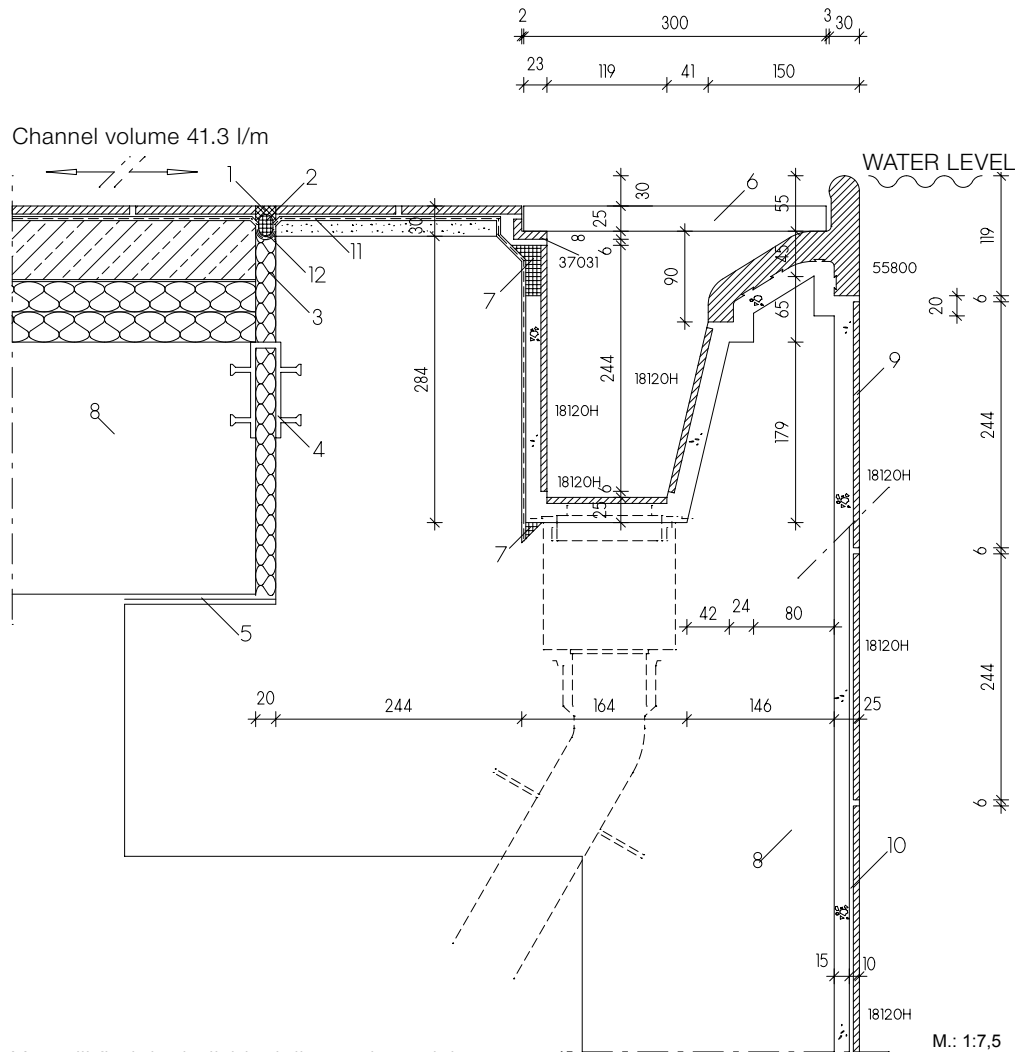

You will find the individual tiles and special pieces (= model numbers) of this system under:

18120H = Chroma tile (page 148 ff)
 55800 = Pool edging tile (page 93)
 37031 = Supporting angle for grating (page 113)
 Cover grating (page 84)

Legend:

01 UW-Silicone
 02 Closed-cell polyethylene foam round lace
 03 Elastic water-resistant filling material
 04 Joint band
 05 Slide bearing
 06 AGROB BUCHTAL plastic cover grating
 07 Capillary barrier/grouting (reaction resin filler)

08 Waterproof concrete (according to DIN EN 206/DIN 1045/DAfStB WU Guideline)
 09 Conventional thick-bed laying
 10 Thin-bed laying on cement render (P III, CS IV without added lime)

11 Sealing layer
 12 Sealing tape
 13 Outlet valve „Silent W 2000“ of AGROB BUCHTAL
 14 Air inlet pipe for outlet „Silent 100“
 15 Epoxi for joints (for the projekt sector)
 16 AGROB BUCHTAL section stoneware pipe
 17 Casing for water inlet/outlet pipe and brazing collar





Designing with edging tiles

Like the pool edge system Berlin (presented on page 63), the Zürich system also has an elevated overflow edge, which serves as a handhold at the same time. However, the channel, which is covered with a plastic grating, is separated from the pool by edging tiles.

Thanks to the combination with pool edging tiles between the overflow edge and the drainage channel, the system is perfectly suitable for use in leisure and adventure pools. In addition, Zürich offers immense scope in terms of construction technique and aesthetic aspects. Thus, different channel volumes can be realized, depending on the requirements.

Kombibad Gropiusstadt, Berlin, Germany / Architect: Veauthier Meyer Architekten
Series: Pool edge system Zürich / Photo: Jochen Stüber



Zürich

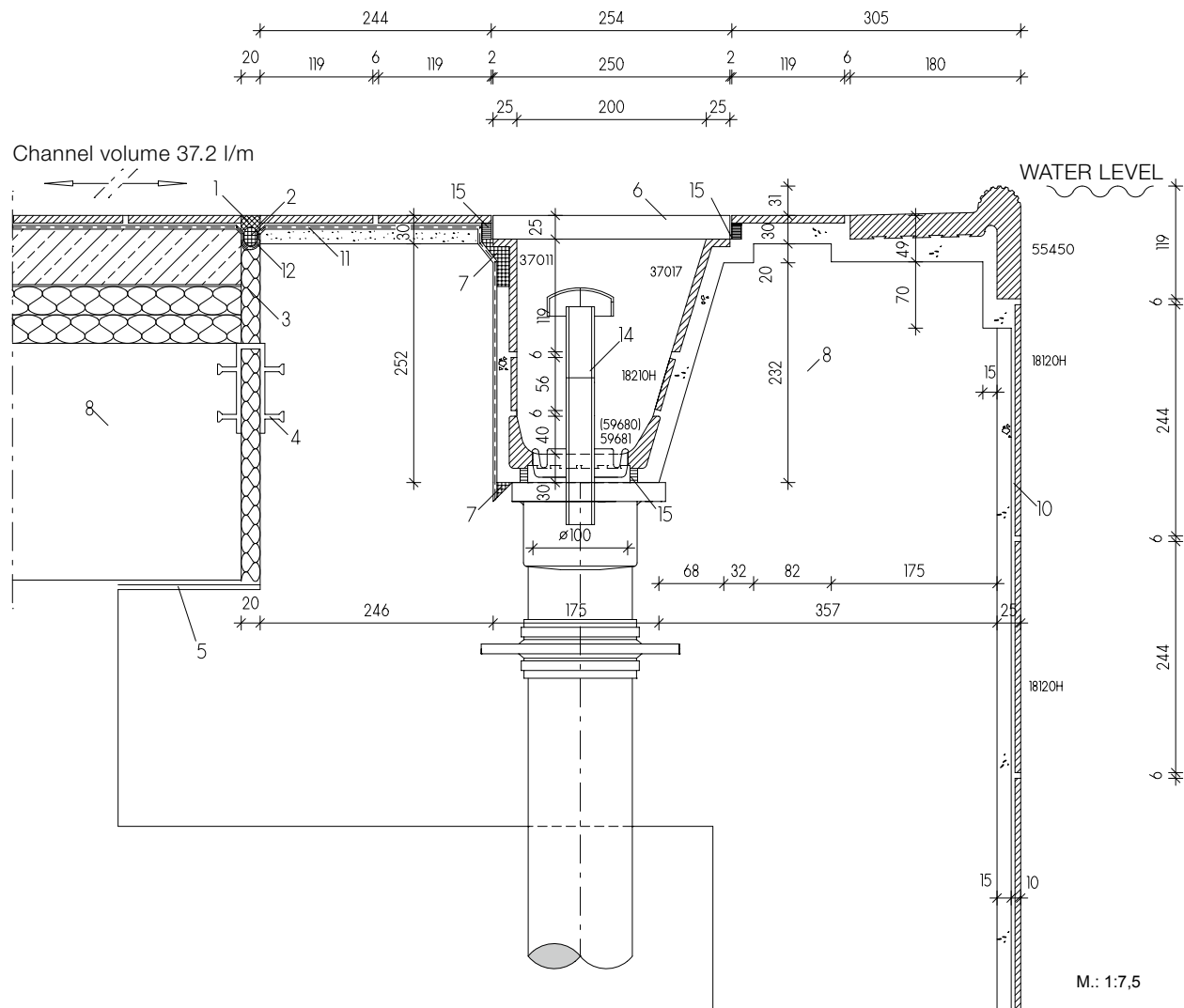

You will find the individual tiles and special pieces (= model numbers) of this system under:

- 18120H = Chroma tile (page 148 ff)
- 55450 = Pool edging tile (page 92)
- 37017 = Shank-tile (page 113)
- 18210H = Chroma tile (page 148 ff)
- 59681 = Coved gutter with outlet (page 113)
- 59680 = Coved gutter tile (page 113)
- 37011 = Shank-tile (page 113)
- Cover grating (page 84)
- Outlet valve Silent 100 (page 113)

Legend:

- 01 UW-Silicone
- 02 Closed-cell polyethylene foam round lace
- 03 Elastic water-resistant filling material
- 04 Joint band
- 05 Slide bearing
- 06 AGROB BUCHTAL plastic cover grating
- 07 Capillary barrier/grouting (reaction resin filler)

- 08 Waterproof concrete (according to DIN EN 206/DIN 1045/DAfStB WU Guideline)
- 09 Conventional thick-bed laying
- 10 Thin-bed laying on cement render (P III, CS IV without added lime)
- 11 Sealing layer
- 12 Sealing tape
- 13 Outlet valve „Silent W 2000“ of AGROB BUCHTAL
- 14 Air inlet pipe for outlet „Silent 100“
- 15 Epoxi for joints (for the projekt sector)
- 16 AGROB BUCHTAL section stoneware pipe
- 17 Casing for water inlet/outlet pipe and brazing collar



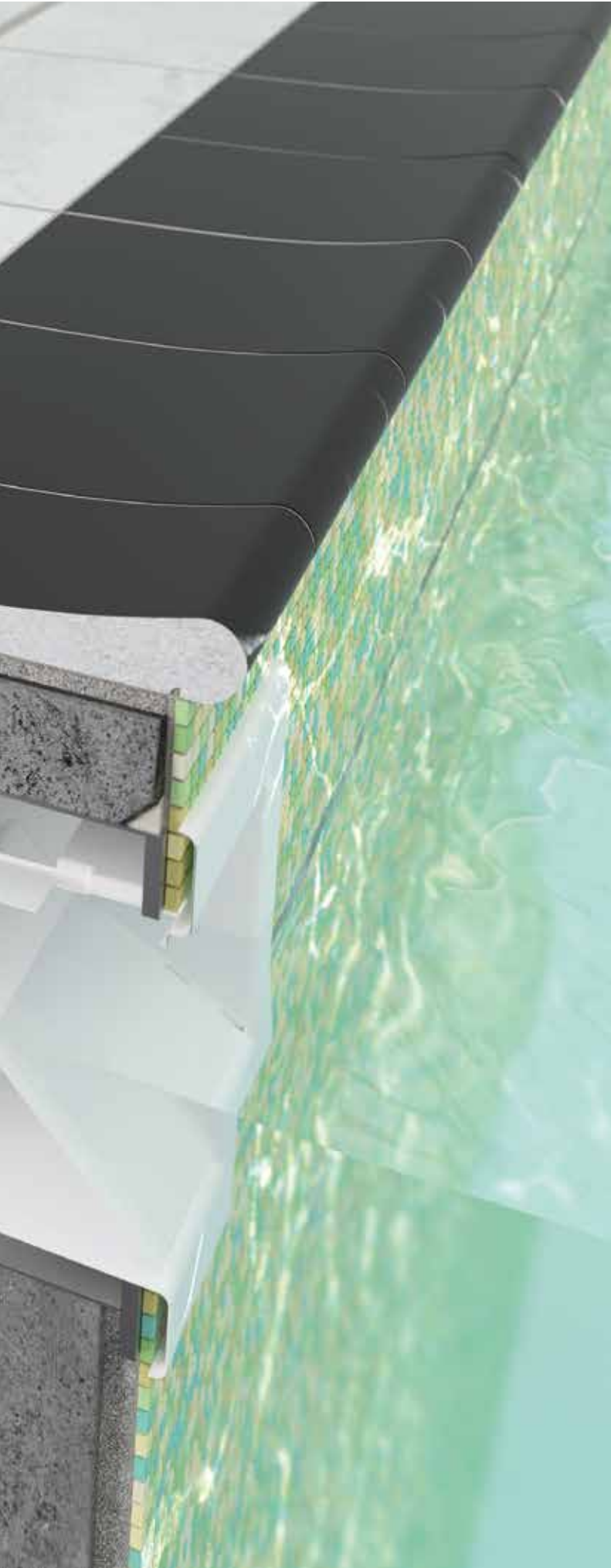

Low budget for private swimming pools

Wherever a low-cost solution for private pools is in demand, the Skimmer system is an ideal solution. For the water technology, only little effort is required. In terms of design, Skimmer offers individual freedom by different designs of the pool edge and the choice of suitable special pieces.

Villa in Southern Germany / Architect: own planning / Series: Natural Ceramics / Photo: Herbert Bürger



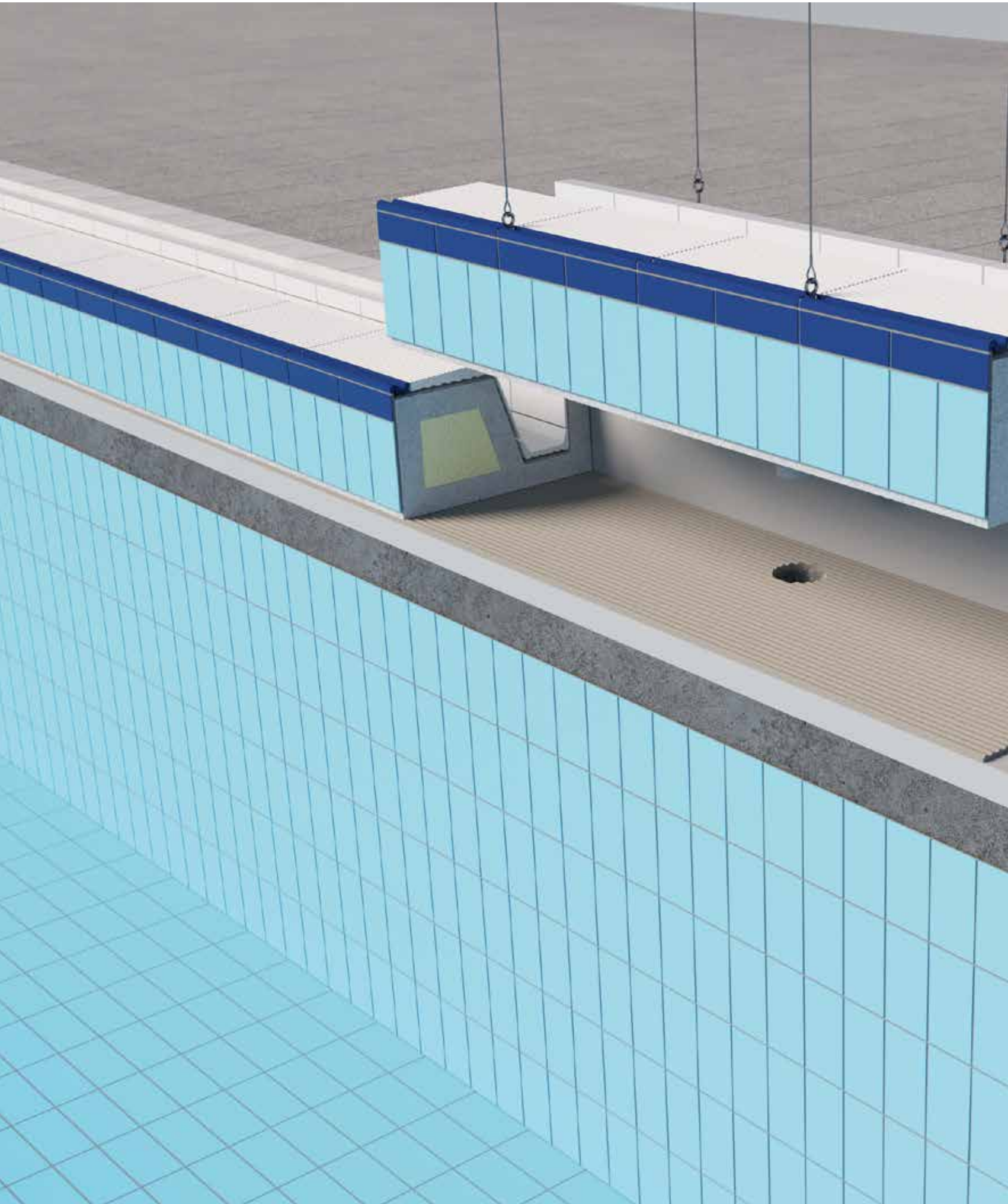



Ceramics on the outside, carbon-reinforced concrete core

The new prefabricated parts for the refurbishment of older pool edges ensure very simple and time-saving construction processes. In addition, they enable long-lasting, resource-efficient and therefore sustainable renovation solutions.

In cooperation with the engineering service provider CARBOCON from Dresden, which is experienced in the field of the innovative building material carbon-reinforced concrete, AGROB BUCHTAL has developed a completely new renovation solution: a pool edge completely prefabricated with tiles and a core made of carbon-reinforced concrete.

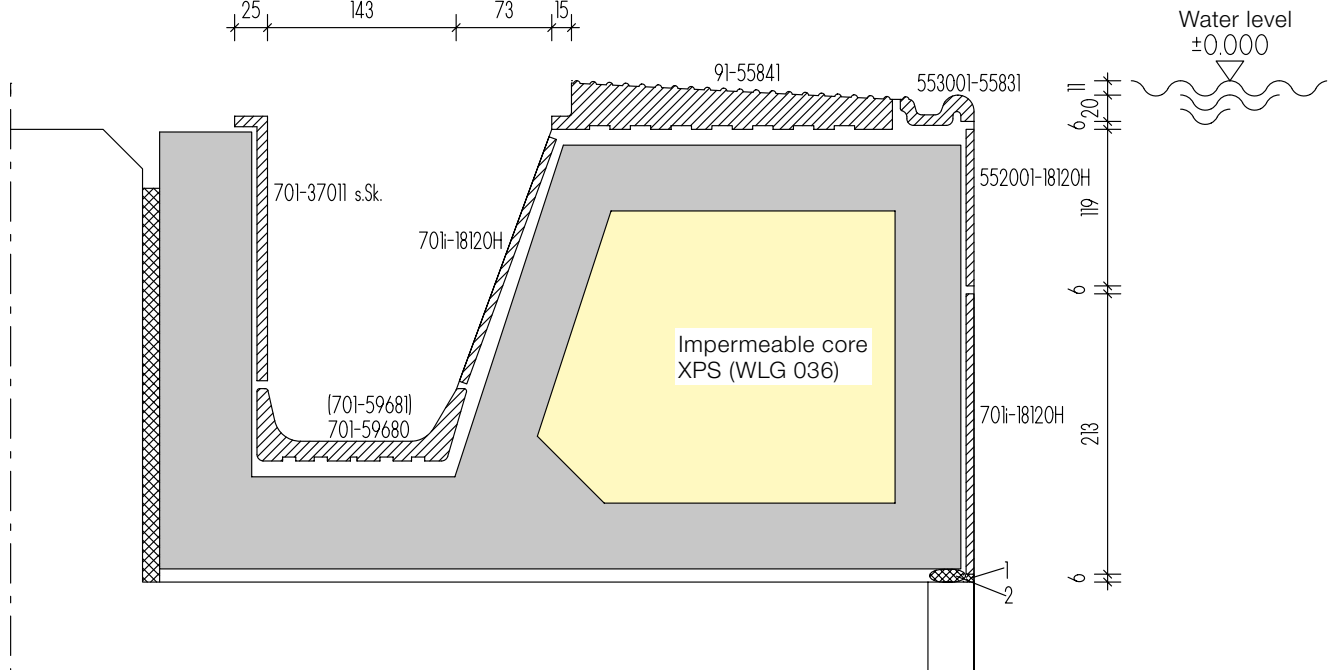
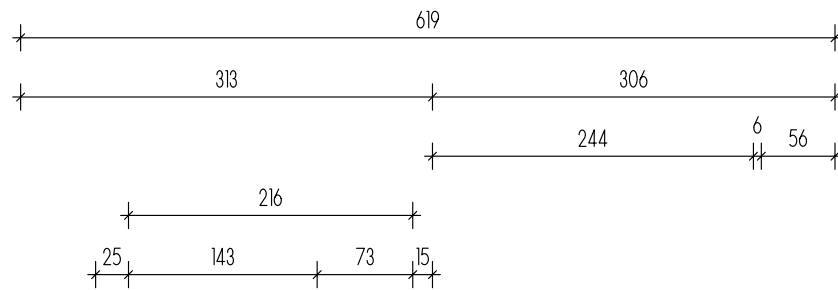

Advantages of prefabrication

The prefabrication of the pool edges under controlled and quality-monitored workshop conditions enables energy- and resource-efficient production processes and minimized waste quantities – and a product quality which can not be achieved on construction sites. But also the construction processes on site are much simpler with the prefabricated parts because complicated work steps and the involvement of many different trades are not required. The overall construction time is also reduced because formwork, pouring and drying of the in-situ concrete are no longer necessary. To further improve the carbon footprint, AGROB BUCHTAL relies on short delivery routes and has the prefabricated parts produced with reusable formwork.

Pool edges as ceramic prefabricated parts: simple and quick installation on site

To be able to install the prefabricated parts, which usually are 2.5 metres long, the old pool edges, independent of the manufacturer or type, are cut out first of all. The result is precise horizontal and vertical cutting edges onto which – after pre-treatment of the cut steel reinforcement and sealing of the cut surface – the new prefabricated pool edges are simply placed in mortar. The position of existing channel drains is measured project-specifically and taken into account at the production of the prefabricated parts. Finally, the connection works to the pool surround (such as e.g. capillary barrier) and to the pool tiles are carried out. As the transition to the existing pool tiles – provided that these are retained – is considerably below the water level, possible differences in color between the tiles and the joints are hardly visible, so that the pool edge and the pool appear as a uniform whole as before.

Detailed information and prices on request.

to the film

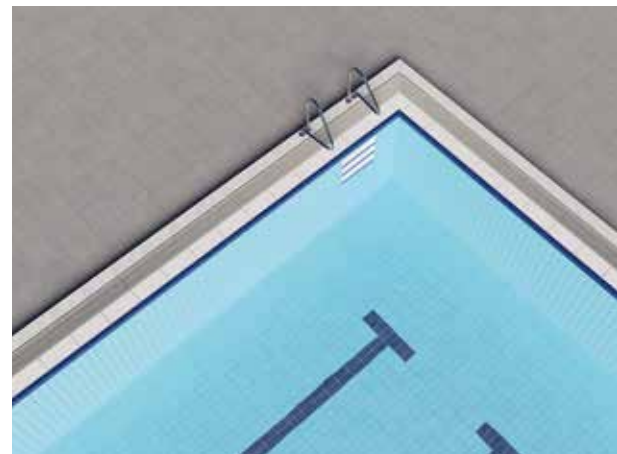
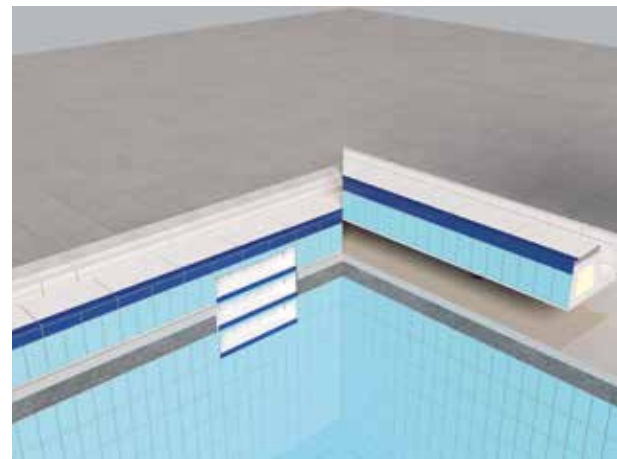
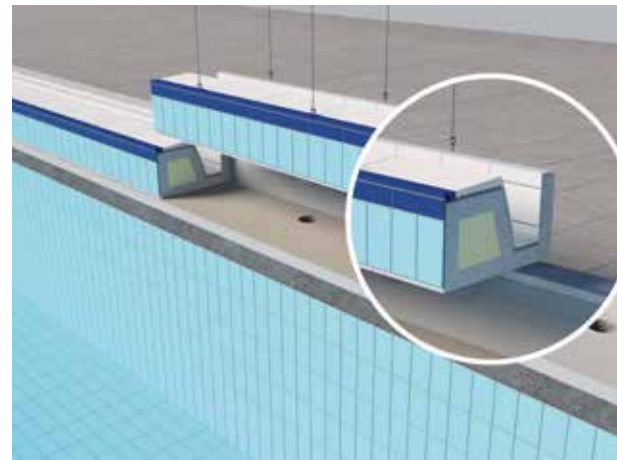

Series: Pool edge system Wiesbaden Silent





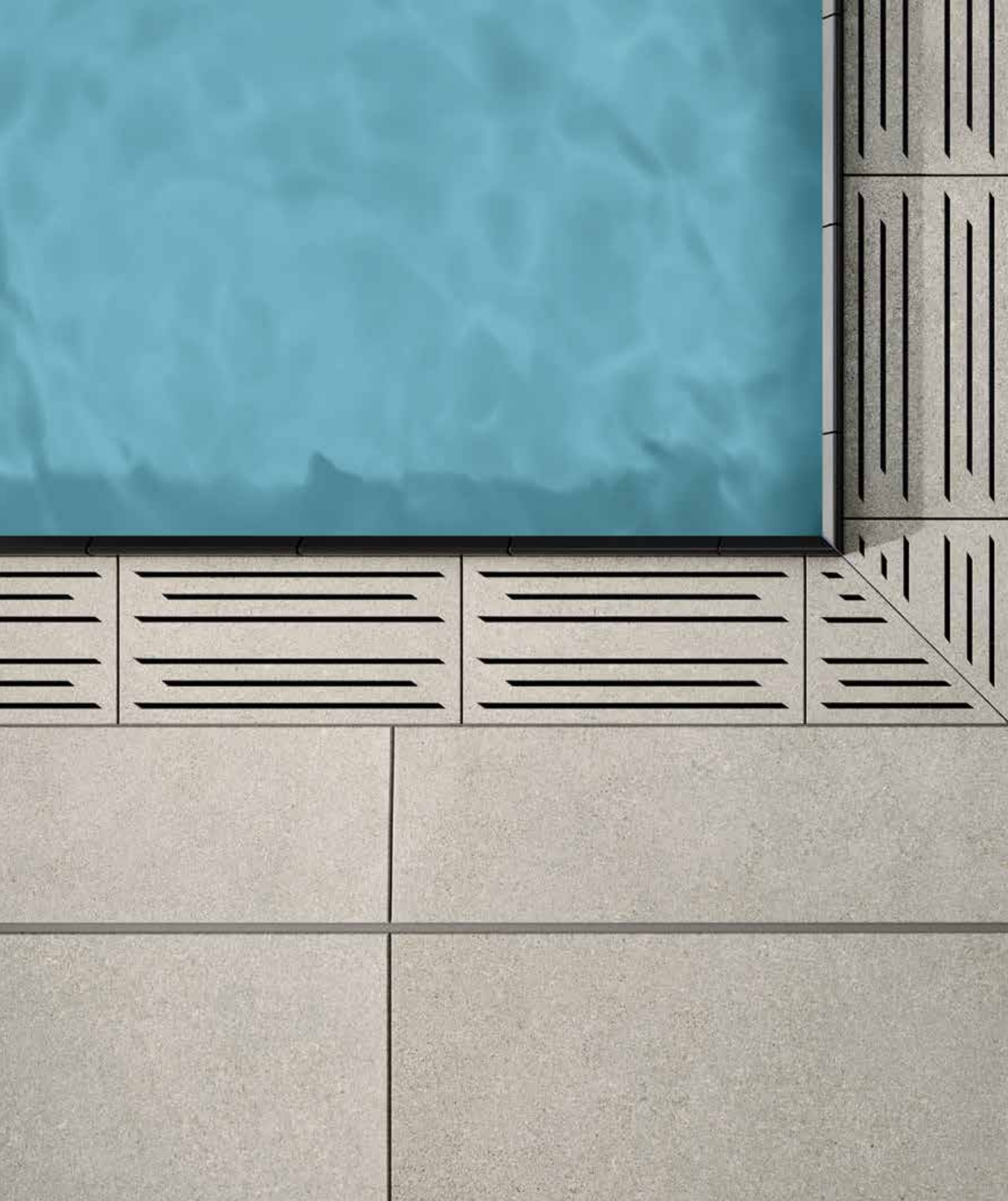



Ceramic channel cover for private and hotel pools

Exclusive design options are opened up by the pool edge system "Wiesbaden Stil": by using the ceramic channel cover, the entire pool surround inclusive of the pool edge can be designed in a uniform look. The colors and the special surfaces of the tile series Area Pro, Ascona, Quarzit, Valley and Emotion are available. The supports and base plates of the channel cover are also supplied in matching colors. The cover is slip-resistant and very robust. Plug-in connections ensure quick and easy laying. On request, different formats and free forms are also available. Water flow rate: free cross-section 245 cm²/m in case of the standard hole pattern.

Rendering / Series: Area Pro

Cross-section

Cover tile 8 mm
(Quarzit)

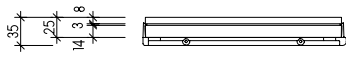

Cross-section

Cover tile 10,5 mm (Area Pro)
Cover tile 10 mm (Valley)

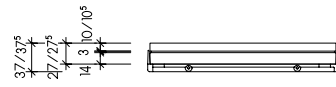

External corner

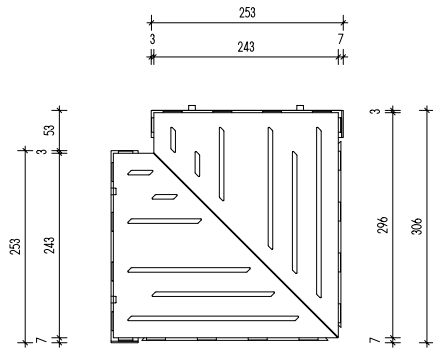

Internal corner

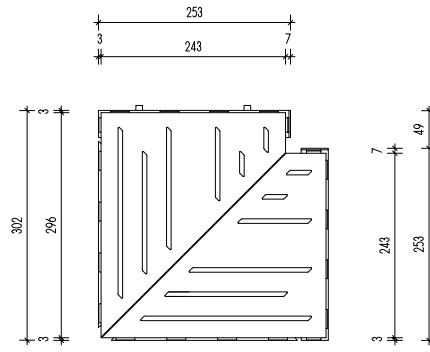

Ceramic cover grating

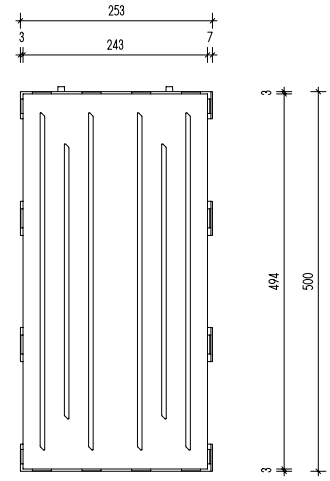

Available surfaces:

Area Pro, Ascona, Emotion, Quarzit, Valley



Rendering / Series: Area Pro

Top-quality cover gratings

Even with regard to details which are often hardly noticed, high quality pays off: cover gratings from AGROB BUCHTAL, available as transverse or parallel gratings, are made of high-quality, high impact strength plastics with UV absorber, connection of the individual slats by means of tear-resistant PUR round cord and intermediate rolls in a color matching the individual slats. The gratings are designed for the loads to be expected by being walked on barefoot. It is almost impossible to break individual rods.



Transverse gratings

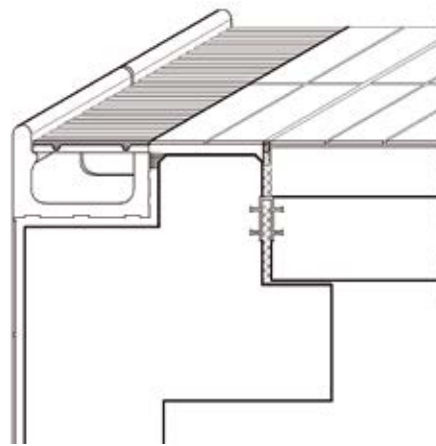

Parallel gratings

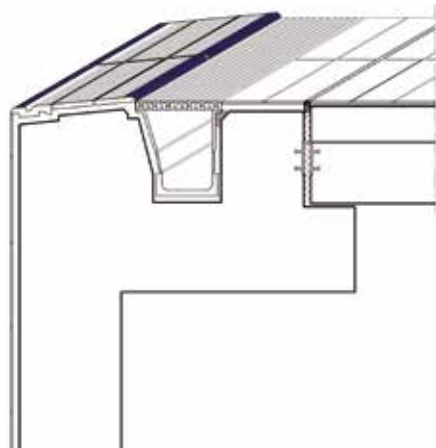

Transverse gratings, flexible¹

Grating thickness	25 mm	25 mm
Grating width	191 mm	250 mm
Article-no.	R10000	R10100
Transverse grating, flexible	Price gr. A722 (lin. m.)	Price gr. A731 (lin. m.)

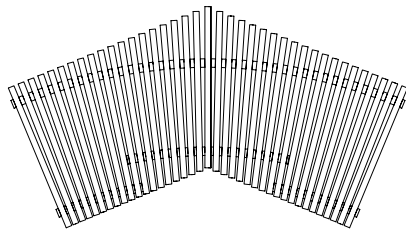

Fan-shaped corner, art. no.: R12100
Transverse grating, 250 mm wide

Transverse gratings, rigid, for the low-noise channel³

Grating thickness	25 mm	25 mm
Grating width	191 mm	250 mm
Article-no.	R20000	R20100
Transverse grating	Price gr. A731 (lin. m.)	Price gr. A757 (lin. m.)
Article-no.	R21000	R21100
Mitred corners 1E+AE+Special ²	Price gr. A750 (pce.)	Price gr. A766 (pce.)

¹ Also available as fan-shaped corner and curved grating. Prices on request.

² All corner elements are rigid.

³ Also available as curved grating. Price on request.

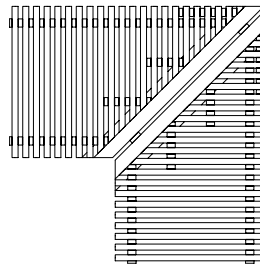

Mitred corner, art. no.: R21100
Transverse grating, 250 mm wide

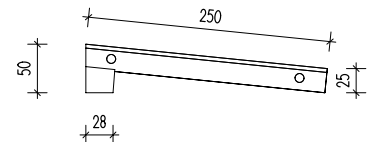

Art. no.: R40100
Inclined transverse grating,
250 mm wide

Parallel gratings, rigid⁵

Grating thickness	25 mm
Grating width	250 mm
Article-No.	R50100
Parallel grating	Price gr. A748 (lin. m.)
Article-No.	R51100
Mitred corners 1E+AE+Special ⁴	Price gr. A791 (pce.)

⁴ All corner elements are rigid.

⁵ Not available as curved gratings for technical reasons.

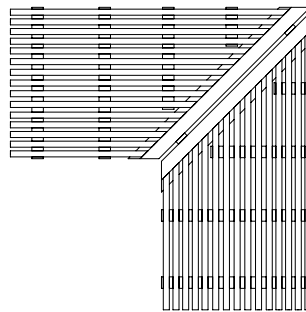

Mitred corner, art. no.: R51100
Parallel grating, 250 mm wide

Survey of colors:

Distinction by the last figure of the article number

Last figure 0 = Standard colors (grey = RAL7001 / white = RAL9010 /
beige = RAL1001 / yellow = RAL1018)

Last figure 1 = Semi-colors (light ivory = RAL1015 / traffic blue = RAL5017 /
traffic red = RAL3020 / deep black = RAL9005)

Last figure 2 = Special colors according to RAL (except Metallic shades)

Outlet valve Silent W 2000 (patented)

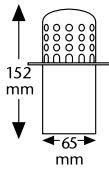

Outlet valve Silent 100 (patented) With optimized connecting system

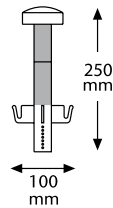

Outlet (brass with sieve of V4A)

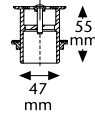

Draining volume max. 2,4 m³/h (installation with gutter tile)

The water drainage takes place almost silently at a considerably increased flow rate. Silent W 2000 and Silent 100 consist of high-quality material (PVC-free) which is equally resistant to water treated with chlorine, salt, ozone, thermal and mineral water as to the cleaning agents normally used in swimming pools.

Ø 75 mm	Ø 86 mm	Ø 100 mm	1 1/2 inches	Fits opening with
Fits overflow channel 55141, 86161	Fits overflow channels 55101, 85161, 55181, 85191, 95161, 87161, 85181	Fits covered gutter tile 59681	Fits covered gutter tile 54421	
178 Price gr. A723 (pce.)	179 Price gr. A723 (pce.)	177 Price gr. A723 (pce.)	182 Price gr. A668 (pce.)	Article-No.
178-S (black) Price gr. A731 (pce.)	179-S (black) Price gr. A731 (pce.)			Article-No.

Note: Rebate for accessories is separately regulated!

No pallet rebate is granted for the products shown on this page.

Paracelsus Bad & Kurhaus, Salzburg, Austria / Architect: Berger + Parkkinen / Series: Pool edge systems Wiesbaden, Savona / Photo: Christian Richters

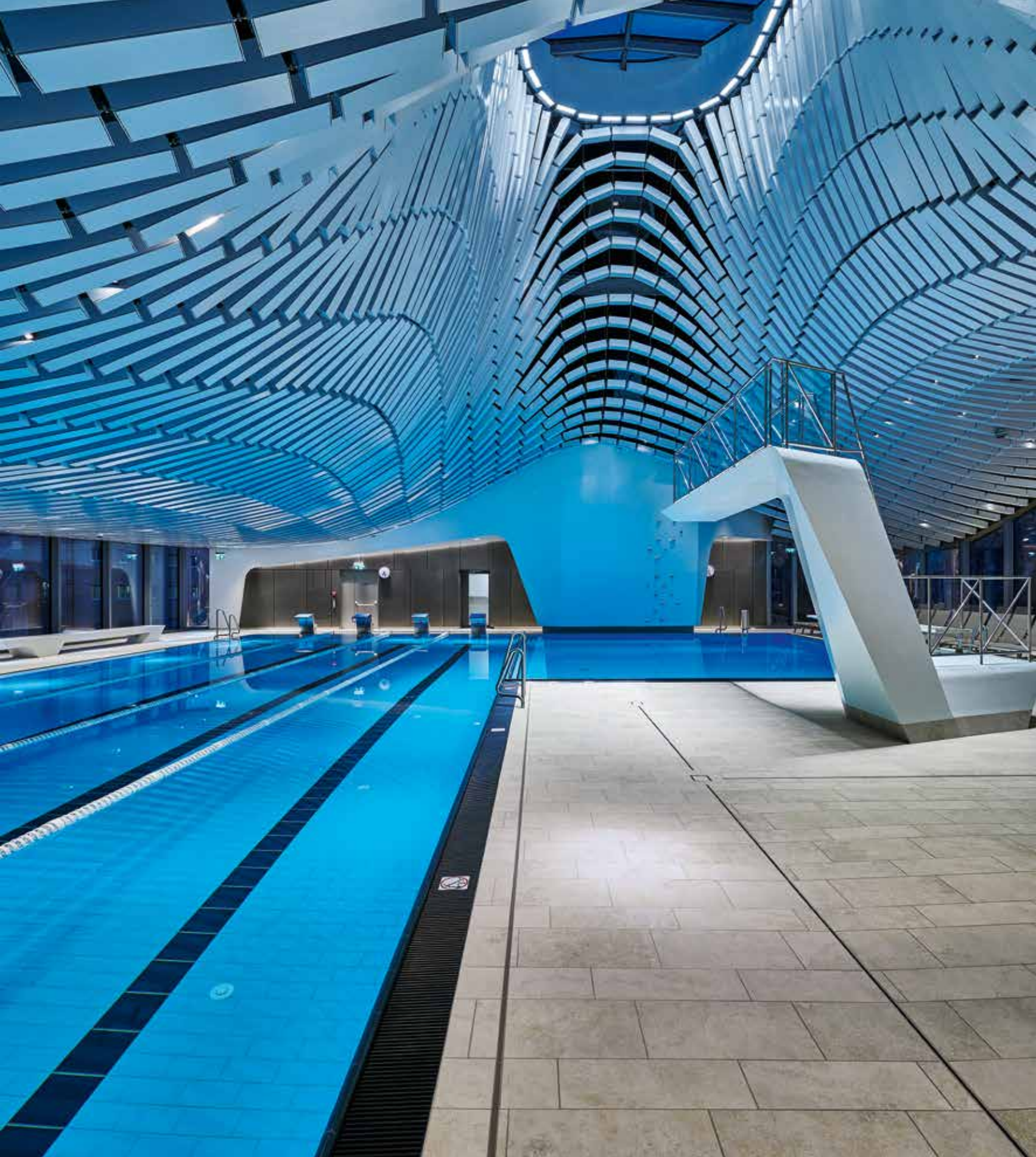



Swimming pool special pieces

Variety of practical special pieces

No matter how complex a pool design may be – a variety of well thought-out and solid ceramic special pieces guarantee a problem-free realization. The appropriate pool end pieces can be combined from the various systems according to the modular principle. Special forms such as rounded edges with profiled edgings, skirtings or cove skirtings in diverse designs ensure a minimum risk of injury and maximum ease of cleaning and care as well as robustness.

- Pool edging tiles
- Skirtings
- Profiled edgings
- Profiled edgings
- Grooved tiles
- Special tiles

Solebad Werne, Germany / Architect: Geising + Böker GmbH, Büro Vechta /
Series: Pool edge system Finland / Photo: Jochen Stüber





At the pool edge

Pool edging tiles can be found in all pool edge designs at which the edge is not already part of the pool edge system, such as the system Wiesbaden, for example. Or for bordering the pool in places where no drainage channel is provided. They have several functions: in addition to a colored marking of the pool edge both inside and outside the pool, pool edging tiles offer above all a safe hold for the swimmer and therefore are an important safety feature. For different designs of the pool edge, several variants are available, some of which can be used across different types of design.

Terrassenbad, Baden, Switzerland / Architect: Bridevaux M. + Zimmermann M. Architekten AG, Baden / Series: Plural unglazed / Photo: Adriano Faragulo

e.g. for the Systems Zürich, Wiesbaden with decreased water level, "Skimmer" etc.³



Art. no. 55440

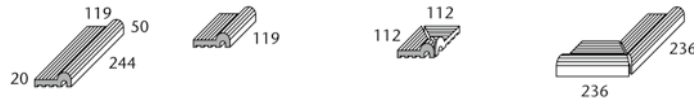

	Pool edging tile	"Half-size" Pool edging tile	Internal corner (mitred pair)	External corner (mitred pair) Corner radius 30 mm			
Model number	55440	55445	55442	55446			
Nom. dim. - cm							
Work size mm	244 x 119/50 x 20	119 x 119/50 x 20	(2x) 112 x 112/50 x 20	(2x) 236 x 119/50 x 20			
m - pieces	4.000	8.000					
Pce./pair - kg	1.550/piece	0.780/piece	0.600/pair	2.500/pair			
Bundle - pce./pair	10 pieces	20 pieces	2 pairs	5 pairs			
Bundle - m	2.500	2.500					
Bundle - kg	15.500	15.600	1.200	12.500			
Product standard	Alb	Alb	Alb	Alb			
Slip resistance	-/C	-/C	-/C	-/C			
	900-55440	900-55445	900-55442	900-55446			
grey-beige <input type="checkbox"/>	Price gr. A511 (pce.)	Price gr. A467 (pce.)	Price gr. A533 (pair)	Price gr. A608 (pair)			
900 grey-beige	700-55440	700-55445	700-55442	700-55446			
700 n10/white gl. <input type="checkbox"/>	Price gr. A528 (pce.)	Price gr. A475 (pce.)	Price gr. A545 (pair)	Price gr. A625 (pair)			
900 grey-beige	701-55440	701-55445	701-55442	701-55446			
701 n10/white matt <input type="checkbox"/>	Price gr. A528 (pce.)	Price gr. A475 (pce.)	Price gr. A545 (pair)	Price gr. A625 (pair)			
900 grey-beige	552001-55440	552001-55445	552001-55442	552001-55446			
552001 active azure <input type="checkbox"/>	Price gr. A545 (pce.)	Price gr. A484 (pce.)	Price gr. A560 (pair)	Price gr. A645 (pair)			
900 grey-beige	552002-55440	552002-55445	552002-55442	552002-55446			
552002 light azure <input type="checkbox"/>	Price gr. A545 (pce.)	Price gr. A484 (pce.)	Price gr. A560 (pair)	Price gr. A645 (pair)			
900 grey-beige	5716-55440²	5716-55445²	5716-55442²	5716-55446²			
5716 n1/black <input type="checkbox"/>	Price gr. A545 (pce.)	Price gr. A484 (pce.)	Price gr. A560 (pair)	Price gr. A645 (pair)			



e.g. for the Systems Zürich, Wiesbaden with decreased water level, "Skimmer" etc.⁴



Art. no. 55450



	Pool edging tile lower edge unglazed	"Half-size" Pool edging tile	Internal corner (mitred pair)	External corner (mitred pair) Corner radius 30 mm			
Model number	55450	55455	55452	55456			
Nom. dim. - cm							
Work size mm	244 x 180/119 x 28	119 x 180/119 x 28	(2x) 173 x 173 x 28	(2x) 236 x 180/119 x 28			
m - pieces	4.000	8.000					
Pce./pair - kg	3.700/piece	1.800/piece	1.800/pair	5.500/pair			
Bundle - pce./pair	4 pieces	8 pieces	2 pairs	1 pair			
Bundle - m	1.000	1.000					
Bundle - kg	14.800	14.400	3.600	5.500			
Product standard	Alb	Alb	Alb	Alb			
Slip resistance	-/C	-/C	-/C	-/C			
81 n10/white	900039-55450	900039-55455	900039-55452	900039-55456			
700 n10/white gl. <input type="checkbox"/>	Price gr. A625 (pce.)	Price gr. A560 (pce.)	Price gr. A663 (pair)	Price gr. A748 (pair)			
81 n10/white	900464-55450	900464-55455	900464-55452	900464-55456			
701 n10/white matt <input type="checkbox"/>	Price gr. A625 (pce.)	Price gr. A560 (pce.)	Price gr. A663 (pair)	Price gr. A748 (pair)			
81 n10/white	900566-55450	900566-55455	900566-55452	900566-55456			
552001 active azure <input type="checkbox"/>	Price gr. A645 (pce.)	Price gr. A573 (pce.)	Price gr. A683 (pair)	Price gr. A766 (pair)			
81 n10/white	900674-55450	900674-55455	900674-55452	900674-55456			
552002 light azure <input type="checkbox"/>	Price gr. A645 (pce.)	Price gr. A573 (pce.)	Price gr. A683 (pair)	Price gr. A766 (pair)			
81 n10/white	900615-55450²	900615-55455²	900615-55452²	900615-55456²			
5716 n1/black <input type="checkbox"/>	Price gr. A645 (pce.)	Price gr. A573 (pce.)	Price gr. A683 (pair)	Price gr. A766 (pair)			

¹ For cover gratings, refer to page 84, coved gutter tiles refer to page 113

² For reasons of production, differences in color between special pieces and standard tiles can occur.

³ In the case of these special pieces, the overhang and the grooves are glazed in the respective colors.

⁴ In the case of these special pieces, the overhang and the grooves are glazed in the respective colors, the tread surface is white (81).

No pallet rebate is granted for the products shown on this page.

 The products shown on this page can also be produced in other colors of the series Chroma and Chroma non-slip. We will be pleased to check the possibility of such a special production upon request.

e.g. for the Systems Zürich, Wiesbaden with decreased water level, "Skimmer" etc.⁴

25 x 30 cm

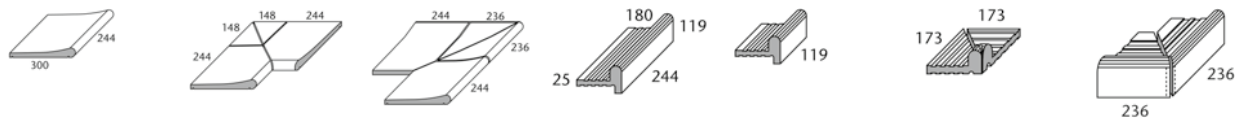

Residence ²	Internal corner 4 parts	External corner 4 parts	Pool edging tile	"Half-size" Pool edging tile	Internal corner (mitred pair)	External corner (mitred pair) Corner radius 30 mm	
55520	55522	55526	55460	55465	55462	55466	Model number
25 x 30 / 10 x 12							Nom. dim. - cm
244 x 300 x 20/42	(2x) 398/102 x 300 x 20/42	(2x) 490 x 300 x 20/42	244 x 180/119 x 25	119 x 180/119 x 25	(2x) 173 x 173 x 25	(2x) 236 x 180/119 x 25	Work size mm
4.000			4.000	8.000			m - pieces
4.300/piece	11.900/piece	11.900/piece	3.720/piece	1.800/piece	1.500/pair	5.700/pair	Pce./pair - kg
4 pieces	1 pieces	1 pieces	4 pieces	8 pieces	4 pairs	1 pair	Bundle - pce./pair
1.000			1.000	1.000			Bundle - m
17.200	11.900	11.900	14.880	14.400	6.000	5.700	Bundle - kg
Alb	Alb	Alb	Alb	Alb	Alb	Alb	Product standard
-/B	-/B	-/B					Slip resistance
			700-55460	700-55465	700-55462	700-55466	neutral 10 (active
			Price gr. A625 (pce.)	Price gr. A560 (pce.)	Price gr. A654 (pair)	Price gr. A734 (pair)	(white glossy) <input type="checkbox"/>
			701-55460	701-55465	701-55462	701-55466	neutral 10 (active
			Price gr. A625 (pce.)	Price gr. A560 (pce.)	Price gr. A654 (pair)	Price gr. A734 (pair)	(shite matt) <input type="checkbox"/>
			552001-55460	552001-55465	552001-55462	552001-55466	active azure <input type="checkbox"/>
			Price gr. A645 (pce.)	Price gr. A573 (pce.)	Price gr. A683 (pair)	Price gr. A748 (pair)	
			552002-55460	552002-55465	552002-55462	552002-55466	light azure <input type="checkbox"/>
			Price gr. A645 (pce.)	Price gr. A573 (pce.)	Price gr. A683 (pair)	Price gr. A748 (pair)	
			5716-55460³	5716-55465³	5716-55462³	5716-55466³	neutral 1
			Price gr. A645 (pce.)	Price gr. A573 (pce.)	Price gr. A683 (pair)	Price gr. A748 (pair)	(deep black) <input type="checkbox"/>
91-55520	91-55522	91-55526					neutral 10
Price gr. A514 (pce.)	Price gr. A668 (pair)	Price gr. A741 (pair)					(active white) <input type="checkbox"/>
553001-55520	553001-55522	553001-55526					
Price gr. A528 (pce.)	Price gr. A683 (pair)	Price gr. A757 (pair)					active azure <input type="checkbox"/>



for System Berlin



			Pool edging tile	"Half-size" Pool edging tile	Internal corner (mitred pair)	External corner (mitred pair) Corner radius 30 mm	
			55800	55805	55802	55806	Art. Nr. 55800
			244 x 150/119 x 25/30	119 x 150/119 x 25/30	(2x) 143 x 143/119	(2x) 236 x 150/119 x 25/30	Model number
			4.000	8.000			Nom. dim. - cm
			3.700/piece	1.800/piece	1.600/pair	5.400/pair	Work size mm
			3 pieces	6 pieces	1 pair	1 pair	m - pieces
			0.750	0.750			Pce./pair - kg
			11.100	10.800	1.600	5.400	Bundle - pce./pair
			Alb	Alb	Alb	Alb	Bundle - m
			700-55800	700-55805	700-55802	700-55806	Bundle - kg
			Price gr. A638 (pce.)	Price gr. A577 (pce.)	Price gr. A668 (pair)	Price gr. A754 (pair)	Product standard
			701-55800	701-55805	701-55802	701-55806	neutral 10 (active
			Price gr. A638 (pce.)	Price gr. A577 (pce.)	Price gr. A668 (pair)	Price gr. A754 (pair)	(white glossy) <input type="checkbox"/>
			552001-55800	552001-55805	552001-55802	552001-55806	neutral 10 (active
			Price gr. A654 (pce.)	Price gr. A587 (pce.)	Price gr. A683 (pair)	Price gr. A766 (pair)	(shite matt) <input type="checkbox"/>
			552002-55800	552002-55805	552002-55802	552002-55806	active azure <input type="checkbox"/>
			Price gr. A654 (pce.)	Price gr. A587 (pce.)	Price gr. A683 (pair)	Price gr. A766 (pair)	
			5716-55800³	5716-55805³	5716-55802³	5716-55806³	light azure <input type="checkbox"/>
			Price gr. A654 (pce.)	Price gr. A587 (pce.)	Price gr. A683 (pair)	Price gr. A766 (pair)	neutral 1
							(deep black) <input type="checkbox"/>



 The products shown on this page can also be produced in other colors of the series Chroma and Chroma non-slip. We will be pleased to check the possibility of such a special production upon request.

¹ For cover gratings, refer to page 84, coved gutter tiles refer to page 113
² For this article, conic cuts are possible upon request.
³ For reasons of production, differences in color between special pieces and standard tiles can occur.
⁴ In the case of these special pieces, the overhang and the grooves are glazed in the respective colors.



No pallet rebate is granted for the products shown on this page.





Skirtings combined with profiled edgings

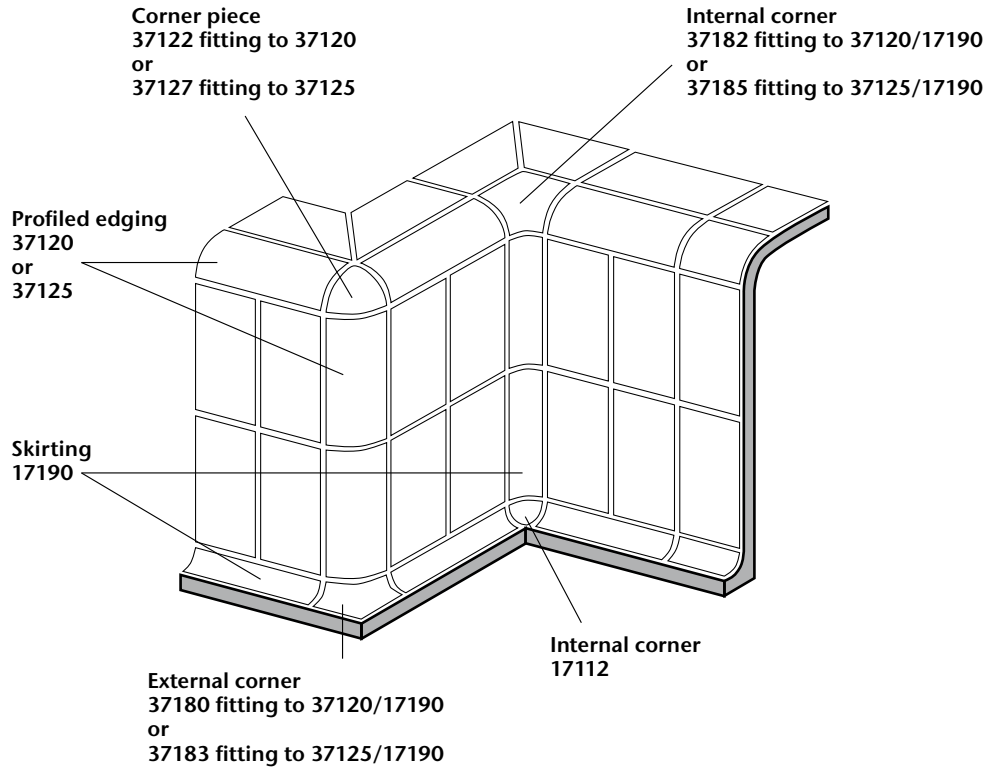

Cove Skirting combined with profiled edgings

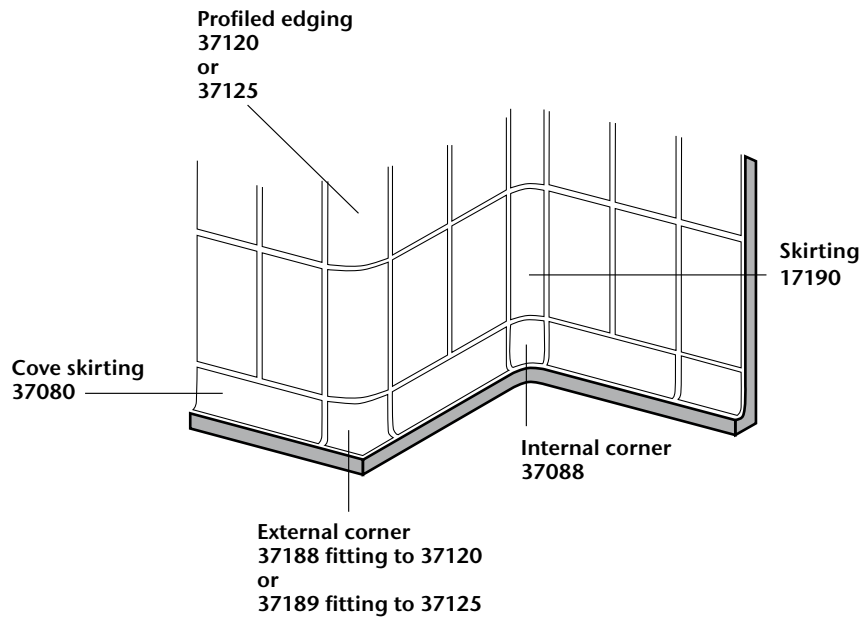

Radius 33 mm²

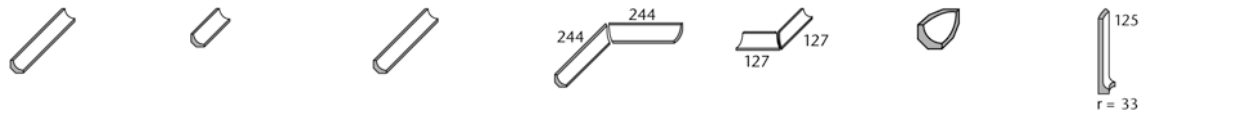

Skirting, r = 33 mm	Skirting "half-size"	End-skirting	Internal corner mitred pair	External corner mitred pair	Internal corner for skirtings for connection on 3 sides	Internal corner for the connection of cove skirting 37080 and skirting 17190		Stress group
17190	17193	17191	17196	17194	17112	37088		Model number
244 x r33 x 6	119 x r33 x 6	244 x r33 x 6	244/244 x r33 x 6	127/127 x r33 x 6	33 x 33 x 33	125 x r33 x 8		Nom. dim.
4.000	8.000							Work size mm
0.300/piece	0.140/piece	0.300/piece	0.550/pair	0.350/pair	0.090/piece	0.300/piece		m - pieces
54 pieces	108 pieces	54 pieces	27 pairs	24 pairs				Pce./pair - kg
13.500	13.500							Bundle - pce./pair
16.200	15.120	16.200	14.850	8.400				Bundle - m
Alb	Alb	Alb	Alb	Alb	Alb	Alb		Bundle - kg
700-17190	700-17193	700-17191	700-17196	700-17194	700-17112	700-37088	4	Product standard
Price gr. A423 (pce.)	Price gr. A413 (pce.)	Price gr. A425 (pce.)	Price gr. A471 (pair)	Price gr. A471 (pair)	Price gr. A434 (pce.)	Price gr. A480 (pce.)		neutral 10 (active
701-17190	701-17193	701-17191	701-17196	701-17194	701-17112	701-37088	4	(white glossy) <input type="checkbox"/>
Price gr. A423 (pce.)	Price gr. A413 (pce.)	Price gr. A425 (pce.)	Price gr. A471 (pair)	Price gr. A471 (pair)	Price gr. A434 (pce.)	Price gr. A480 (pce.)		neutral 10 (active
552001-17190	552001-17193	552001-17191	552001-17196	552001-17194	552001-17112	552001-37088	2	(white matt) <input type="checkbox"/>
Price gr. A425 (pce.)	Price gr. A416 (pce.)	Price gr. A428 (pce.)	Price gr. A475 (pair)	Price gr. A475 (pair)	Price gr. A438 (pce.)	Price gr. A484 (pce.)		active azure <input type="checkbox"/>
552002-17190	552002-17193	552002-17191	552002-17196	552002-17194	552002-17112	552002-37088	4	light azure <input type="checkbox"/>
Price gr. A425 (pce.)	Price gr. A416 (pce.)	Price gr. A428 (pce.)	Price gr. A475 (pair)	Price gr. A475 (pair)	Price gr. A438 (pce.)	Price gr. A484 (pce.)		neutral 1
5716-17190³	5716-17193³	5716-17191³	5716-17196³	5716-17194³	5716-17112³	5716-37088³	1	(deep black) <input type="checkbox"/>
Price gr. A425 (pce.)	Price gr. A416 (pce.)	Price gr. A428 (pce.)	Price gr. A475 (pair)	Price gr. A475 (pair)	Price gr. A438 (pce.)	Price gr. A484 (pce.)		grey-beige <input type="checkbox"/>
900-17190²	900-17193²	900-17191²	900-17196²	900-17194²	900-17112²	900-37088²		
Price gr. A428 (pce.)	Price gr. A416 (pce.)	Price gr. A434 (pce.)	Price gr. A487 (pair)	Price gr. A487 (pair)	Price gr. A442 (pce.)	Price gr. A480 (pce.)		



Radius 60 mm

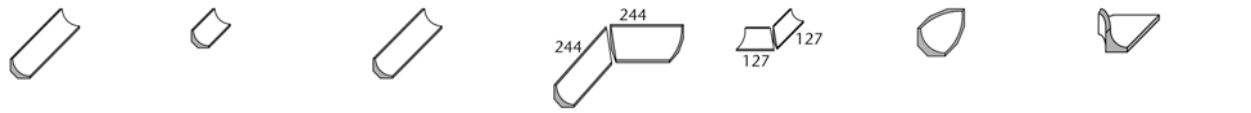

Skirting, r = 33 mm	Skirting "half-size"	End-skirting	Internal corner mitred pair	External corner mitred pair	Internal corner for skirtings for connection on 3 sides	Internal corner for the connection of cove skirting 37080 and skirting 17190		Stress group
18190	18193	18191	18196	18194	18192	37186		Model number
244 x r60 x 8	119 x r60 x 8	244 x r60 x 8	244/244 x r60 x 8	127/127 x r60 x 8	60 x 60 x 60			Nom. dim.
4.000	8.000							Work size mm
0.700/piece	0.340/piece	0.700/piece	1.300/pair	0.850/pair	0.100/piece	0.350/piece		m - pieces
18 pieces	36 pieces	18 pieces	9 pair	7 pair				Pce./pair - kg
4.500	4.500							Bundle - pce./pair
12.600	12.240	12.600	11.700	5.950				Bundle - m
Alb	Alb	Alb	Alb	Alb	Alb	Alb		Bundle - kg
700-18190	700-18193	700-18191	700-18196	700-18194	700-18192	700-37186	4	Product standard
Price gr. A458 (pce.)	Price gr. A438 (pce.)	Price gr. A471 (pce.)	Price gr. A506 (pair)	Price gr. A506 (pair)	Price gr. A449 (pce.)	Price gr. A528 (pce.)		neutral 10 (active
701-18190	701-18193	701-18191	701-18196	701-18194	701-18192	701-37186	4	(white glossy) <input type="checkbox"/>
Price gr. A458 (pce.)	Price gr. A438 (pce.)	Price gr. A471 (pce.)	Price gr. A506 (pair)	Price gr. A506 (pair)	Price gr. A449 (pce.)	Price gr. A528 (pce.)		neutral 10 (active
552001-18190	552001-18193	552001-18191	552001-18196	552001-18194	552001-18192	552001-37186	2	(white matt) <input type="checkbox"/>
Price gr. A463 (pce.)	Price gr. A441 (pce.)	Price gr. A475 (pce.)	Price gr. A511 (pair)	Price gr. A511 (pair)	Price gr. A452 (pce.)	Price gr. A539 (pce.)		active azure <input type="checkbox"/>
552002-18190	552002-18193	552002-18191	552002-18196	552002-18194	552002-18192	552002-37186	4	light azure <input type="checkbox"/>
Price gr. A463 (pce.)	Price gr. A441 (pce.)	Price gr. A475 (pce.)	Price gr. A511 (pair)	Price gr. A511 (pair)	Price gr. A452 (pce.)	Price gr. A539 (pce.)		neutral 1
5716-18190³	5716-18193³	5716-18191³	5716-18196³	5716-18194³	5716-18192³	5716-37186³	1	(deep black) <input type="checkbox"/>
Price gr. A463 (pce.)	Price gr. A441 (pce.)	Price gr. A475 (pce.)	Price gr. A511 (pair)	Price gr. A511 (pair)	Price gr. A452 (pce.)	Price gr. A539 (pce.)		grey-beige <input type="checkbox"/>
900-18190¹	900-18193¹	900-18191¹	900-18196¹	900-18194¹	900-18192¹	900-37186¹		
Price gr. A467 (pce.)	Price gr. A445 (pce.)	Price gr. A480 (pce.)	Price gr. A519 (pair)	Price gr. A519 (pair)	Price gr. A455 (pce.)	Price gr. A545 (pce.)		



¹ System also available in a length of 294 mm on request.
³ For reasons of production, differences in color between special pieces and standard tiles can occur.

 The products shown on this page can also be produced in other colors of the series Chroma and Chroma non-slip. We will be pleased to check the possibility of such a special production upon request.

Cove skirtings

25 x 6.6 cm



25 x 12.5 cm



	Berlin skirting	External corner	Internal corner	Skirting, r = 12 mm	External corner mitred pair	Internal corner mitred pair	
Model number	37090	37091	37092	37080	37081	37082	
Nom. dim. - cm/in	25 x 6.6 / 10 x 2 5/8			25 x 12.5 / 10 x 5			
Work size mm	244 x 60/8 x 6	(2x) 35 x 60/8 x 6	(2x) 25 x 60/8 x 6	244 x 125/12 x 8	(2x) 131 x 125/12 x 8	(2x) 119 x 125/12 x 8	
m - pieces	4.000			4.000			
Pce./pair - kg	0.230/piece	0.100/piece	0.100/piece	0.630/piece	0.600/pair	0.400/pair	
Bundle - pce./pair	40 pieces	72 pieces	192 pieces	20 pieces	10 pairs	10 pairs	
Bundle - m	10.000			5.000			
Bundle - kg	9.200	7.200	19.200	12.600	6.000	4.000	
Product standard	Alb	Alb	Alb	Alb	Alb	Alb	
neutral 10 (active)	4			700-37080	700-37081	700-37082	
(white glossy)				Price gr. A434 (pce.)	Price gr. A475 (pair)	Price gr. A475 (pair)	
neutral 10 (active)	4			701-37080	701-37081	701-37082	
(white matt)	Price gr. A434 (pce.)	Price gr. A463 (pce.)	Price gr. A463 (pce.)	Price gr. A434 (pce.)	Price gr. A475 (pair)	Price gr. A475 (pair)	



Skirtings

20 x 7.9 cm



25 x 7.9 cm



30 x 7.9 cm



25 x 6.2 cm



20 x 10 cm



25 x 12.5 cm



	44025	34020	44026	37024	37023	37021	
Model number	44025	34020	44026	37024	37023	37021	
Nom. dim. - cm/in	20 x 7.9 / 8 x 3 1/8	25 x 7.9 / 10 x 3 1/8	30 x 7.9 / 12 x 3 1/8	25 x 6.2 / 10 x 2 1/2	20 x 10 / 8 x 4	25 x 12.5 / 10 x 5	
Work size mm	194 x 73 x 8	244 x 73 x 8	294 x 73 x 8	244 x 56/56 x 8	194 x 94/56 x 8	244 x 119/56 x 8	
m - pieces	5.000	4.000	3.333	4.000	5.000	4.000	
Pce./pair - kg	0.240	0.290	0.360	0.440	0.510	0.730	
Bundle - pce./pair	33	33	30	24	10	10	
Bundle - m	6.600	8.250	9.000	6.000	2.000	2.500	
Bundle - kg	7.920	9.570	10.800	10.560	5.100	7.300	
Product standard	Alb	Alb	Alb	Alb	Alb	Alb	
neutral 10 (active)	4			700-37024	700-37023	700-37021	
(white glossy)				Price gr. A423 (pce.)	Price gr. A434 (pce.)	Price gr. A441 (pce.)	
neutral 10 (active)	4			701-37024	701-37023	701-37021	
(white matt)	Price gr. A410 (pce.)	Price gr. A410 (pce.)	Price gr. A411 (pce.)	Price gr. A423 (pce.)	Price gr. A434 (pce.)	Price gr. A441 (pce.)	



 The products shown on this page can also be produced in other colors of the series Chroma and Chroma non-slip. We will be pleased to check the possibility of such a special production upon request.

Radius 30 mm



Profiled edging, r = 30 mm	"half-size" profiled edging	Corner piece	External corner for the connection of skirting 17190 and profiled edging 37120	External corner for the connection of cove skirting 37080 and profiled edging 37120	Internal corner for the connection of skirting 17190 and profiled edging 37120	Stress group	Model number
37120	37121	37122	37180	37188	37182		Nom. dim. - cm
244 x r30 x 8	119 x r30 x 8						Work size mm
4.000	8.000						m - pieces
0.190	0.100	0.030	0.120	0.300	0.090		Pieces - kg
99	198						Bundle - pieces
24.750	24.750						Bundle - m
18.810	19.800						Bundle - kg
Alb	Alb	Alb	Alb	Alb	Alb		Product standard
see below	see below	see below	see below	see below	see below		Slip resistance
700-37120 Price gr. A438 (pce.)	700-37121 Price gr. A423 (pce.)	700-37122 Price gr. A467 (pce.)	700-37180 Price gr. A480 (pce.)	700-37188 Price gr. A519 (pce.)	700-37182 Price gr. A519 (pce.)	4	neutral 10 (active (white glossy)) <input type="checkbox"/>
701-37120 Price gr. A438 (pce.)	701-37121 Price gr. A423 (pce.)	701-37122 Price gr. A467 (pce.)	701-37180 Price gr. A480 (pce.)	701-37188 Price gr. A519 (pce.)	701-37182 Price gr. A519 (pce.)	4	neutral 10 (active (white matt)) <input type="checkbox"/>
552001-37120 Price gr. A441 (pce.)	552001-37121 Price gr. A425 (pce.)	552001-37122 Price gr. A471 (pce.)	552001-37180 Price gr. A484 (pce.)	552001-37188 Price gr. A528 (pce.)	552001-37182 Price gr. A528 (pce.)	2	active azure <input type="checkbox"/>
552002-37120 Price gr. A441 (pce.)	552002-37121 Price gr. A425 (pce.)	552002-37122 Price gr. A471 (pce.)	552002-37180 Price gr. A484 (pce.)	552002-37188 Price gr. A528 (pce.)	552002-37182 Price gr. A528 (pce.)	4	light azure <input type="checkbox"/>
5716-37120² Price gr. A441 (pce.)	5716-37121² Price gr. A425 (pce.)	5716-37122² Price gr. A471 (pce.)	5716-37180² Price gr. A484 (pce.)	5716-37188² Price gr. A528 (pce.)	5716-37182² Price gr. A528 (pce.)	1	neutral 1 (deep black) <input type="checkbox"/>
-/B <input type="checkbox"/>	-/B <input type="checkbox"/>	-/B <input type="checkbox"/>	-/B <input type="checkbox"/>	-/B <input type="checkbox"/>	-/B <input type="checkbox"/>		
91-37120 Price gr. A445 (pce.)	91-37121 Price gr. A428 (pce.)	91-37122 Price gr. A475 (pce.)	91-37180 Price gr. A489 (pce.)	91-37188 Price gr. A539 (pce.)	91-37182 Price gr. A539 (pce.)		neutral 10 (active white) <input type="checkbox"/>
-/B <input type="checkbox"/>	-/B <input type="checkbox"/>	-/B <input type="checkbox"/>	-/B <input type="checkbox"/>	-/B <input type="checkbox"/>	-/B <input type="checkbox"/>		
553001-37120 Price gr. A449 (pce.)	553001-37121 Price gr. A430 (pce.)	553001-37122 Price gr. A480 (pce.)	553001-37180 Price gr. A506 (pce.)	553001-37188 Price gr. A545 (pce.)	553001-37182 Price gr. A545 (pce.)		active azure <input type="checkbox"/>
-/B <input type="checkbox"/>	-/B <input type="checkbox"/>	-/B <input type="checkbox"/>	-/B <input type="checkbox"/>	-/B <input type="checkbox"/>	-/B <input type="checkbox"/>		
553002-37120 Price gr. A449 (pce.)	553002-37121 Price gr. A430 (pce.)	553002-37122 Price gr. A480 (pce.)	553002-37180 Price gr. A506 (pce.)	553002-37188 Price gr. A545 (pce.)	553002-37182 Price gr. A545 (pce.)		light azure <input type="checkbox"/>
-/B <input type="checkbox"/>	-/B <input type="checkbox"/>	-/B <input type="checkbox"/>	-/B <input type="checkbox"/>	-/B <input type="checkbox"/>	-/B <input type="checkbox"/>		
340-37120 Price gr. A449 (pce.)	340-37121 Price gr. A430 (pce.)	340-37122 Price gr. A480 (pce.)	340-37180 Price gr. A506 (pce.)	340-37188 Price gr. A545 (pce.)	340-37182 Price gr. A545 (pce.)		neutral 1 (deep black) <input type="checkbox"/>
-/C <input type="checkbox"/>	-/C <input type="checkbox"/>	-/C <input type="checkbox"/>	-/C <input type="checkbox"/>	-/C <input type="checkbox"/>	-/C <input type="checkbox"/>		
81-37120 Price gr. A445 (pce.)	81-37121 Price gr. A428 (pce.)	81-37122 Price gr. A475 (pce.)	81-37180 Price gr. A489 (pce.)	81-37188 Price gr. A539 (pce.)	81-37182 Price gr. A539 (pce.)		neutral 10 (active white) <input type="checkbox"/>
-/C <input type="checkbox"/>	-/C <input type="checkbox"/>	-/C <input type="checkbox"/>	-/C <input type="checkbox"/>	-/C <input type="checkbox"/>	-/C <input type="checkbox"/>		
554001-37120 Price gr. A449 (pce.)	554001-37121 Price gr. A430 (pce.)	554001-37122 Price gr. A480 (pce.)	554001-37180 Price gr. A506 (pce.)	554001-37188 Price gr. A545 (pce.)	554001-37182 Price gr. A545 (pce.)		active azure <input type="checkbox"/>
-/C <input type="checkbox"/>	-/C <input type="checkbox"/>	-/C <input type="checkbox"/>	-/C <input type="checkbox"/>	-/C <input type="checkbox"/>	-/C <input type="checkbox"/>		
554002-37120 Price gr. A449 (pce.)	554002-37121 Price gr. A430 (pce.)	554002-37122 Price gr. A480 (pce.)	554002-37180 Price gr. A506 (pce.)	554002-37188 Price gr. A545 (pce.)	554002-37182 Price gr. A545 (pce.)		light azure <input type="checkbox"/>
-/C <input type="checkbox"/>	-/C <input type="checkbox"/>	-/C <input type="checkbox"/>	-/C <input type="checkbox"/>	-/C <input type="checkbox"/>	-/C <input type="checkbox"/>		
554111-37120 Price gr. A449 (pce.)	554111-37121 Price gr. A430 (pce.)	554111-37122 Price gr. A480 (pce.)	554111-37180 Price gr. A506 (pce.)	554111-37188 Price gr. A545 (pce.)	554111-37182 Price gr. A545 (pce.)		neutral 1 (deep black) <input type="checkbox"/>
-/C <input type="checkbox"/>	-/C <input type="checkbox"/>	-/C <input type="checkbox"/>	-/C <input type="checkbox"/>	-/C <input type="checkbox"/>	-/C <input type="checkbox"/>		
R10/A 900-37120¹ Price gr. A438 (pce.)	R10/A 900-37121¹ Price gr. A423 (pce.)	R10/A 900-37122¹ Price gr. A467 (pce.)	R10/A 900-37180¹ Price gr. A480 (pce.)	R10/A 900-37188¹ Price gr. A519 (pce.)	R10/A 900-37182¹ Price gr. A519 (pce.)		grey-beige <input type="checkbox"/>



² For reasons of production, differences in color between special pieces and standard tiles can occur.

 The products shown on this page can also be produced in other colors of the series Chroma and Chroma non-slip. We will be pleased to check the possibility of such a special production upon request.





Radius 60 mm



External corner for the connection of skirting 17190 and profiled edging 37125

External corner for the connection of cove skirting 37080 and profiled edging 37125

Internal corner for the connection of skirting 17190 and profiled edging 37125

	Profiled edging, r = 60 mm	"half-size" profiled edging	Corner piece	External corner for the connection of skirting 17190 and profiled edging 37125	External corner for the connection of cove skirting 37080 and profiled edging 37125	Internal corner for the connection of skirting 17190 and profiled edging 37125
Model number	37125	37126	37127	37183	37189	37185
Nom. dim. - cm						
Work size mm	244 x r60 x 8	119 x r60 x 8				
m - pieces	4.000	8.000				
Pieces - kg	0.380	0.190	0.100	0.250	0.300	0.200
Bundle - pieces	24	48				
Bundle - m	6.000	6.000				
Bundle - kg	9.120	9.120				
Product standard	Alb	Alb	Alb	Alb	Alb	Alb
Slip resistance	see below	see below	see below	see below	see below	see below
Stress group						
neutral 10 (active white glossy)	4 700-37125 Price gr. A467 (pce.)	700-37126 Price gr. A438 (pce.)	700-37127 Price gr. A511 (pce.)	700-37183 Price gr. A511 (pce.)	700-37189 Price gr. A533 (pce.)	700-37185 Price gr. A533 (pce.)
neutral 10 (active white matt)	4 701-37125 Price gr. A467 (pce.)	701-37126 Price gr. A438 (pce.)	701-37127 Price gr. A511 (pce.)	701-37183 Price gr. A511 (pce.)	701-37189 Price gr. A533 (pce.)	701-37185 Price gr. A533 (pce.)
active azure	2 552001-37125 Price gr. A471 (pce.)	552001-37126 Price gr. A441 (pce.)	552001-37127 Price gr. A519 (pce.)	552001-37183 Price gr. A519 (pce.)	552001-37189 Price gr. A545 (pce.)	552001-37185 Price gr. A545 (pce.)
light azure	4 552002-37125 Price gr. A471 (pce.)	552002-37126 Price gr. A441 (pce.)	552002-37127 Price gr. A519 (pce.)	552002-37183 Price gr. A519 (pce.)	552002-37189 Price gr. A545 (pce.)	552002-37185 Price gr. A545 (pce.)
neutral 1 (deep black)	1 5716-37125² Price gr. A471 (pce.)	5716-37126² Price gr. A441 (pce.)	5716-37127² Price gr. A519 (pce.)	5716-37183² Price gr. A519 (pce.)	5716-37189² Price gr. A545 (pce.)	5716-37185² Price gr. A545 (pce.)
neutral 10 (active white)	/B 91-37125 Price gr. A475 (pce.)	/B 91-37126 Price gr. A445 (pce.)	/B 91-37127 Price gr. A528 (pce.)	/B 91-37183 Price gr. A528 (pce.)	/B 91-37189 Price gr. A556 (pce.)	/B 91-37185 Price gr. A556 (pce.)
active azure	/B 553001-37125 Price gr. A480 (pce.)	/B 553001-37126 Price gr. A449 (pce.)	/B 553001-37127 Price gr. A539 (pce.)	/B 553001-37183 Price gr. A539 (pce.)	/B 553001-37189 Price gr. A573 (pce.)	/B 553001-37185 Price gr. A573 (pce.)
light azure	/B 553002-37125 Price gr. A480 (pce.)	/B 553002-37126 Price gr. A449 (pce.)	/B 553002-37127 Price gr. A539 (pce.)	/B 553002-37183 Price gr. A539 (pce.)	/B 553002-37189 Price gr. A573 (pce.)	/B 553002-37185 Price gr. A573 (pce.)
neutral 1 (deep black)	/B 340-37125 Price gr. A480 (pce.)	/B 340-37126 Price gr. A449 (pce.)	/B 340-37127 Price gr. A539 (pce.)	/B 340-37183 Price gr. A539 (pce.)	/B 340-37189 Price gr. A573 (pce.)	/B 340-37185 Price gr. A573 (pce.)
neutral 10 (active white)	/C 81-37125 Price gr. A475 (pce.)	/C 81-37126 Price gr. A445 (pce.)	/C 81-37127 Price gr. A528 (pce.)	/C 81-37183 Price gr. A528 (pce.)	/C 81-37189 Price gr. A556 (pce.)	/C 81-37185 Price gr. A556 (pce.)
active azure	/C 554001-37125 Price gr. A480 (pce.)	/C 554001-37126 Price gr. A449 (pce.)	/C 554001-37127 Price gr. A539 (pce.)	/C 554001-37183 Price gr. A539 (pce.)	/C 554001-37189 Price gr. A573 (pce.)	/C 554001-37185 Price gr. A573 (pce.)
light azure	/C 554002-37125 Price gr. A480 (pce.)	/C 554002-37126 Price gr. A449 (pce.)	/C 554002-37127 Price gr. A539 (pce.)	/C 554002-37183 Price gr. A539 (pce.)	/C 554002-37189 Price gr. A573 (pce.)	/C 554002-37185 Price gr. A573 (pce.)
neutral 1 (deep black)	/C 554111-37125 Price gr. A480 (pce.)	/C 554111-37126 Price gr. A449 (pce.)	/C 554111-37127 Price gr. A539 (pce.)	/C 554111-37183 Price gr. A539 (pce.)	/C 554111-37189 Price gr. A573 (pce.)	/C 554111-37185 Price gr. A573 (pce.)
grey-beige	R10/A 900-37125¹ Price gr. A467 (pce.)	R10/A 900-37126¹ Price gr. A438 (pce.)	R10/A 900-37127¹ Price gr. A511 (pce.)	R10/A 900-37183¹ Price gr. A511 (pce.)	R10/A 900-37189¹ Price gr. A533 (pce.)	R10/A 900-37185¹ Price gr. A533 (pce.)



² For reasons of production, differences in color between special pieces and standard tiles can occur.

The products shown on this page can also be produced in other colors of the series Chroma and Chroma non-slip. We will be pleased to check the possibility of such a special production upon request.

Ägeribad, Oberägeri, Switzerland / Architect: Scheitlin Syfrig Architekten AG /
Series: Chroma, Chroma unglazed - Quantum, Loop, Plural, non-slip / Photo: Adriano Faragulo



102 GROOVED TILES

Leisure pool, Baesweiler, Germany / Architect: Planteam Ruhr / Series: Pool edge system Wiesbaden, Valley / Photo: Jochen Stüber





8 mm thick, e.g. for stairs leading into the water and other wet stairs in indoor swimming pools

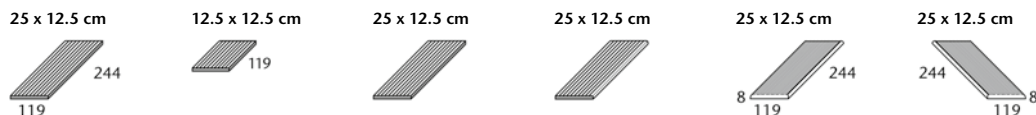

	grooved	"Half-size" tile, grooved	Grooved short side rounded	Grooved long side rounded	Grooved Corner left, rounded	Grooved Corner right, rounded
Model number	34100	34109	34105	34106	34107	34108
Nom. dim. - cm/in	25 x 12.5 / 10 x 5	12.5 x 12.5 / 5 x 5	25 x 12.5 / 10 x 5	25 x 12.5 / 10 x 5	25 x 12.5 / 10 x 5	25 x 12.5 / 10 x 5
Work size	244 x 119 x 8 mm	119 x 119 x 8 mm	244 x 119 x 8 mm	244 x 119 x 8 mm	244 x 119 x 8 mm	244 x 119 x 8 mm
m - pieces	4.000	8.000	4.000	4.000	4.000	4.000
Pieces - kg	0.460	0.230	0.460	0.460	0.460	0.460
Bundle - pieces	33	66	33	33	33	33
Bundle - m	8.250	8.250	8.250	8.250	8.250	8.250
Bundle - kg	15.180	15.180	15.180	15.180	15.180	15.180
Product standard	Alb	Alb	Alb	Alb	Alb	Alb
Slip resistance	-/C	-/C	-/C	-/C	-/C	-/C
	900-34100	900-34109	900-34105	900-34106	900-34107	900-34108
grey-beige <input type="checkbox"/> VO	Price gr. A410 (pce.)	Price gr. A406 (pce.)	Price gr. A413 (pce.)	Price gr. A413 (pce.)	Price gr. A418 (pce.)	Price gr. A418 (pce.)
neutral 10 <input type="checkbox"/>	91i-34100H¹ <input type="checkbox"/>	91i-34109H¹ <input type="checkbox"/>	91i-34105H¹ <input type="checkbox"/>	91i-34106H¹ <input type="checkbox"/>	91i-34107H¹ <input type="checkbox"/>	91i-34108H¹ <input type="checkbox"/>
(active white) <input type="checkbox"/> VO	Price gr. A423 (pce.)	Price gr. A413 (pce.)	Price gr. A434 (pce.)	Price gr. A434 (pce.)	Price gr. A445 (pce.)	Price gr. A445 (pce.)

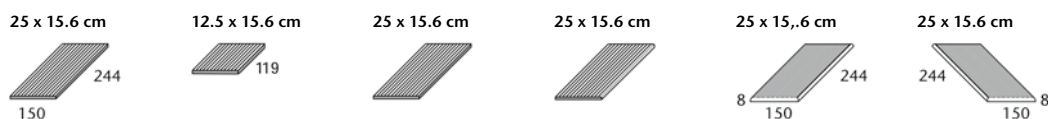



	grooved	"Half-size" tile, grooved	Grooved short side rounded	Grooved long side rounded	Grooved Corner left, rounded	Grooved Corner right, rounded
Model number	34110	34119	34115	34116	34117	34118
Nom. dim. - cm/in	25 x 15.6 / 10 x 6 1/4	12.5 x 15.6 / 5 x 6 1/4	25 x 15.6 / 10 x 6 1/4	25 x 15.6 / 10 x 6 1/4	25 x 15.6 / 10 x 6 1/4	25 x 15.6 / 10 x 6 1/4
Work size	244 x 150 x 8 mm	119 x 150 x 8 mm	244 x 150 x 8 mm	244 x 150 x 8 mm	244 x 150 x 8 mm	244 x 150 x 8 mm
m - pieces	4.000	8.000	4.000	4.000	4.000	4.000
Pieces - kg	0.580	0.280	0.580	0.580	0.580	0.580
Bundle - pieces	33	66	33	33	33	33
Bundle - m	8.250	8.250	8.250	8.250	8.250	8.250
Bundle - kg	19.140	18.480	19.140	19.140	19.140	19.140
Product standard	Alb	Alb	Alb	Alb	Alb	Alb
Slip resistance	-/C	-/C	-/C	-/C	-/C	-/C
	900-34110	900-34119	900-34115	900-34116	900-34117	900-34118
grey-beige <input type="checkbox"/> VO	Price gr. A425 (pce.)	Price gr. A413 (pce.)	Price gr. A434 (pce.)	Price gr. A434 (pce.)	Price gr. A445 (pce.)	Price gr. A445 (pce.)
neutral 10 <input type="checkbox"/>	91i-34110H¹ <input type="checkbox"/>	91i-34119H¹ <input type="checkbox"/>	91i-34115H¹ <input type="checkbox"/>	91i-34116H¹ <input type="checkbox"/>	91i-34117H¹ <input type="checkbox"/>	91i-34118H¹ <input type="checkbox"/>
(active white) <input type="checkbox"/> VO	Price gr. A452 (pce.)	Price gr. A434 (pce.)	Price gr. A475 (pce.)	Price gr. A475 (pce.)	Price gr. A506 (pce.)	Price gr. A506 (pce.)

¹ with Hytect



No pallet rebate is granted for the products shown on this page.

 The products shown on this page can also be produced in other colors of the series Chroma and Chroma non-slip. We will be pleased to check the possibility of such a special production upon request.

Rounded corners			rounded corners
Replace last figure 0 of standard model no. by 7 = corner left	... 8 = corner right	Example: Standard model no. 34100 = 244 x 119 x 8 mm, Model no. 34107 = rounded corner left

8 mm thick, with non-slip safety marking

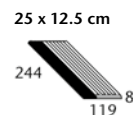
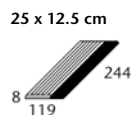
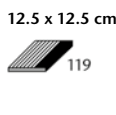
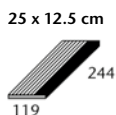

Grooved
long side rounded

"Half-size" tile grooved,
long side rounded

Grooved
Corner left, rounded

Grooved
Corner right, rounded



			34146H	34149H	34147H	34148H	Model number
			25 x 12.5 / 10 x 5	12.5 x 12.5 / 5 x 5	25 x 12.5 / 10 x 5	25 x 12.5 / 10 x 5	Nom. dim. - cm/in
			244 x 119 x 8 mm	119 x 119 x 8 mm	244 x 119 x 8 mm	244 x 119 x 8 mm	Work size
			4.000	8.000	4.000	4.000	m - pieces
			0.460	0.230	0.460	0.460	Pieces - kg
			33	66	33	33	Bundle - pieces
			8.250	8.250	8.250	8.250	Bundle - m
			15.180	15.180	15.180	15.180	Bundle - kg
			Alb	Alb	Alb	Alb	Product standard
			-/C	-/C	-/C	-/C	Slip resistance
			553001-34146H	553001-34149H	553001-34147H	553001-34148H	900 grey-beige
			Price gr. A423 (pce.)	Price gr. A413 (pce.)	Price gr. A430 (pce.)	Price gr. A430 (pce.)	553001 active azure <input type="checkbox"/>
			553002-34146H	553002-34149H	553002-34147H	553002-34148H	900 grey-beige
			Price gr. A423 (pce.)	Price gr. A413 (pce.)	Price gr. A430 (pce.)	Price gr. A430 (pce.)	553002 light azure <input type="checkbox"/>
			340i-34146H	340i-34149H	340i-34147H	340i-34148H	900 grey-beige
			Price gr. A423 (pce.)	Price gr. A413 (pce.)	Price gr. A430 (pce.)	Price gr. A430 (pce.)	340 n1/black <input type="checkbox"/>
			900567-34146H	900567-34149H	900567-34147H	900567-34148H	91 n10/white
			Price gr. A445 (pce.)	Price gr. A434 (pce.)	Price gr. A456 (pce.)	Price gr. A456 (pce.)	553001 active azure <input type="checkbox"/>
			900588-34146H	900588-34149H	900588-34147H	900588-34148H	91 n10/weiß
			Price gr. A445 (pce.)	Price gr. A434 (pce.)	Price gr. A456 (pce.)	Price gr. A456 (pce.)	553002 light azure <input type="checkbox"/>
			900044-34146H	900044-34149H	900044-34147H	900044-34148H	91 n10/white
			Price gr. A445 (pce.)	Price gr. A434 (pce.)	Price gr. A456 (pce.)	Price gr. A456 (pce.)	340 n1/black <input type="checkbox"/>

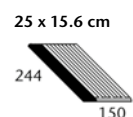
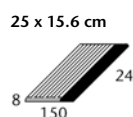
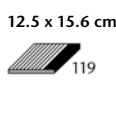
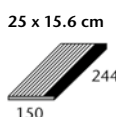

Grooved
long side rounded

"Half-size" tile grooved,
long side rounded

Grooved
Corner left, rounded

Grooved
Corner right, rounded





			34156H	34159H	34157H	34158H	Model number
			25 x 15.6 / 10 x 6 1/4	12.5 x 15.6 / 5 x 6 1/4	25 x 15.6 / 10 x 6 1/4	25 x 15.6 / 10 x 6 1/4	Nom. dim. - cm/in
			244 x 150 x 8 mm	119 x 150 x 8 mm	244 x 150 x 8 mm	244 x 150 x 8 mm	Work size
			4.000	8.000	4.000	4.000	m - pieces
			0.580	0.280	0.580	0.580	Pieces - kg
			33	66	33	33	Bundle - pieces
			8.250	8.250	8.250	8.250	Bundle - m
			19.140	18.480	19.140	19.140	Bundle - kg
			Alb	Alb	Alb	Alb	Product standard
			-/C	-/C	-/C	-/C	Slip resistance
			553001-34156H	553001-34159H	553001-34157H	553001-34158H	900 grey-beige
			Price gr. A438 (pce.)	Price gr. A423 (pce.)	Price gr. A449 (pce.)	Price gr. A449 (pce.)	553001 active azure <input type="checkbox"/>
			553002-34156H	553002-34159H	553002-34157H	553002-34158H	900 grey-beige
			Price gr. A438 (pce.)	Price gr. A423 (pce.)	Price gr. A449 (pce.)	Price gr. A449 (pce.)	553002 light azure <input type="checkbox"/>
			340i-34156H	340i-34159H	340i-34157H	340i-34158H	900 grey-beige
			Price gr. A438 (pce.)	Price gr. A423 (pce.)	Price gr. A449 (pce.)	Price gr. A449 (pce.)	340 n1/black <input type="checkbox"/>
			900567-34156H	900567-34159H	900567-34157H	900567-34158H	91 n10/white
			Price gr. A480 (pce.)	Price gr. A445 (pce.)	Price gr. A506 (pce.)	Price gr. A506 (pce.)	553001 active azure <input type="checkbox"/>
			900588-34156H	900588-34159H	900588-34157H	900588-34158H	91 n10/weiß
			Price gr. A480 (pce.)	Price gr. A445 (pce.)	Price gr. A506 (pce.)	Price gr. A506 (pce.)	553002 light azure <input type="checkbox"/>
			900044-34156H	900044-34159H	900044-34157H	900044-34158H	91 n10/white
			Price gr. A480 (pce.)	Price gr. A445 (pce.)	Price gr. A506 (pce.)	Price gr. A506 (pce.)	340 n1/black <input type="checkbox"/>



 The products shown on this page can also be produced in other colors of the series Chroma and Chroma non-slip. We will be pleased to check the possibility of such a special production upon request.

No pallet rebate is granted for the products shown on this page.

Rounded corners				
Replace last figure 0 of standard model no. by 7 = corner left	... 8 = corner right	rounded corners	Example: Standard model no. 34146 = 119 x 244 x 8 mm, Model no. 34147 = rounded corner left

15 mm thick, e.g. for continuing the Pool Edge System "Finland", for starting blocks etc.

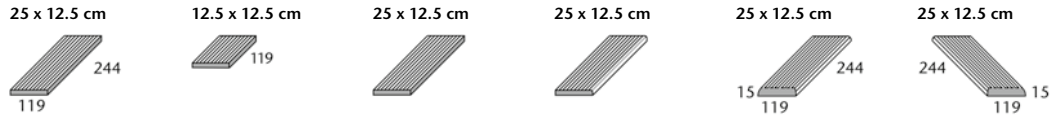

	grooved	"Half-size" tile, grooved	Grooved short side rounded	Grooved long side rounded	Grooved Corner left, rounded	Grooved Corner right, rounded
Model number	53130	53139	53135	53136	53137	53138
Nom. dim. - cm/in	25 x 12.5 / 10 x 5	12.5 x 12.5 / 5 x 5	25 x 12.5 / 10 x 5	25 x 12.5 / 10 x 5	25 x 12.5 / 10 x 5	25 x 12.5 / 10 x 5
Work size	244 x 119 x 15 mm	119 x 119 x 15 mm	244 x 119 x 15 mm	244 x 119 x 15 mm	244 x 119 x 15 mm	244 x 119 x 15 mm
m - pieces	4.000	8.000	4.000	4.000	4.000	4.000
Pieces - kg	0.830	0.420	0.830	0.830	0.830	0.830
Bundle - pieces	16	32	16	16	16	16
Bundle - m	4.000	4.000	4.000	4.000	4.000	4.000
Bundle - kg	13.280	13.440	13.280	13.280	13.280	13.280
Product standard	Alb	Alb	Alb	Alb	Alb	Alb
Slip resistance	-/C	-/C	-/C	-/C	-/C	-/C
grey-beige	900-53130 Price gr. A410 (pce.)	900-53139 Price gr. A406 (pce.)	900-53135 Price gr. A413 (pce.)	900-53136 Price gr. A413 (pce.)	900-53137 Price gr. A418 (pce.)	900-53138 Price gr. A418 (pce.)
neutral 10	91-53130	91-53139	91-53135	91-53136	91-53137	91-53138
(active white)	Price gr. A423 (pce.)	Price gr. A413 (pce.)	Price gr. A434 (pce.)	Price gr. A434 (pce.)	Price gr. A445 (pce.)	Price gr. A445 (pce.)

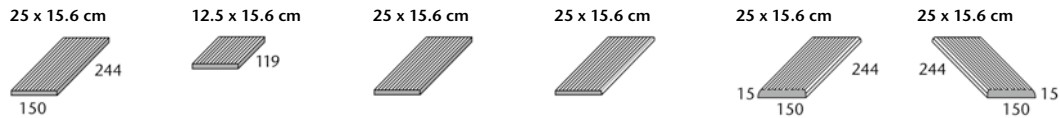

	grooved	"Half-size" tile, grooved	Grooved short side rounded	Grooved long side rounded	Grooved Corner left, rounded	Grooved Corner right, rounded
Model number	53190	53199	53195	53196	53197	53198
Nom. dim. - cm/in	25 x 15.6 / 10 x 6 1/4	12.5 x 15.6 / 5 x 6 1/4	25 x 15.6 / 10 x 6 1/4	25 x 15.6 / 10 x 6 1/4	25 x 15.6 / 10 x 6 1/4	25 x 15.6 / 10 x 6 1/4
Work size	244 x 150 x 15 mm	119 x 150 x 15 mm	244 x 150 x 15 mm	244 x 150 x 15 mm	244 x 150 x 15 mm	244 x 150 x 15 mm
m - pieces	4.000	8.000	4.000	4.000	4.000	4.000
Pieces - kg	1.000	0.490	1.000	1.000	1.000	1.000
Bundle - pieces	18	36	18	18	18	18
Bundle - m	4.500	4.500	4.500	4.500	4.500	4.500
Bundle - kg	18.000	17.640	18.000	18.000	18.000	18.000
Product standard	Alb	Alb	Alb	Alb	Alb	Alb
Slip resistance	-/C	-/C	-/C	-/C	-/C	-/C
grey-beige	900-53190 Price gr. A425 (pce.)	900-53199 Price gr. A413 (pce.)	900-53195 Price gr. A434 (pce.)	900-53196 Price gr. A434 (pce.)	900-53197 Price gr. A445 (pce.)	900-53198 Price gr. A445 (pce.)
neutral 10	91-53190	91-53199	91-53195	91-53196	91-53197	91-53198
(active white)	Price gr. A452 (pce.)	Price gr. A434 (pce.)	Price gr. A475 (pce.)	Price gr. A475 (pce.)	Price gr. A506 (pce.)	Price gr. A506 (pce.)



No pallet rebate is granted for the products shown on this page.

The products shown on this page can also be produced in other colors of the series Chroma and Chroma non-slip. We will be pleased to check the possibility of such a special production upon request.

Rounded corners			rounded corners	Example: Standard model no. 53130 = 119 x 244 x 15 mm, Model no. 53137 = rounded corner left
Replace last figure 0 of standard model no. by 7 = corner left	... 8 = corner right		

15 mm thick, with non-slip safety marking

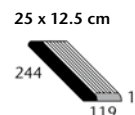
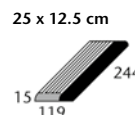
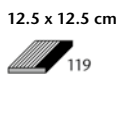
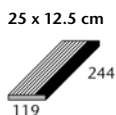

Grooved long side rounded

"Half-size" tile grooved, long side rounded

Grooved corner left, rounded

Grooved corner right, rounded

			59620	59629	59627	59628		Model number	
			25 x 12.5 / 10 x 5	12.5 x 12.5 / 5 x 5	25 x 12.5 / 10 x 5	25 x 12.5 / 10 x 5		Nom. dim. - cm/in	
			244 x 119 x 15 mm	119 x 119 x 15 mm	244 x 119 x 15 mm	244 x 119 x 15 mm		Work size	
			4.000	8.000	4.000	4.000		m - pieces	
			0.830	0.420	0.830	0.830		Pieces - kg	
			16	32	16	16		Bundle - pieces	
			4.000	4.000	4.000	4.000		Bundle - m	
			13.280	13.440	13.280	13.280		Bundle - kg	
			Alb	Alb	Alb	Alb		Product standard	
			-/C	-/C	-/C	-/C		Slip resistance	
			553001-59620	553001-59629	553001-59627	553001-59628		900 grey-beige	
			Price gr. A423 (pce.)	Price gr. A413 (pce.)	Price gr. A430 (pce.)	Price gr. A430 (pce.)		553001 active azure <input type="checkbox"/>	
			553002-59620	553002-59629	553002-59627	553002-59628		900 grey-beige	
			Price gr. A423 (pce.)	Price gr. A413 (pce.)	Price gr. A430 (pce.)	Price gr. A430 (pce.)		553002 light azure <input type="checkbox"/>	
			340-59620	340-59629	340-59627	340-59628		900 grey-beige	
			Price gr. A423 (pce.)	Price gr. A413 (pce.)	Price gr. A430 (pce.)	Price gr. A430 (pce.)		340 n1/black <input type="checkbox"/>	
			900567-59620	900567-59629	900567-59627	900567-59628		91 n10/white	
			Price gr. A445 (pce.)	Price gr. A434 (pce.)	Price gr. A456 (pce.)	Price gr. A456 (pce.)		553001 active azure <input type="checkbox"/>	
			900588-59620	900588-59629	900588-59627	900588-59628		91 n10/white	
			Price gr. A445 (pce.)	Price gr. A434 (pce.)	Price gr. A456 (pce.)	Price gr. A456 (pce.)		553002 light azure <input type="checkbox"/>	
			900044-59620	900044-59629	900044-59627	900044-59628		91 n10/white	
			Price gr. A445 (pce.)	Price gr. A434 (pce.)	Price gr. A456 (pce.)	Price gr. A456 (pce.)		340 n1/black <input type="checkbox"/>	

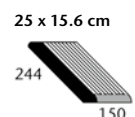
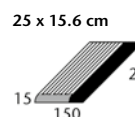
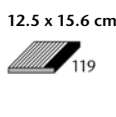
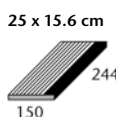

Grooved long side rounded

"Half-size" tile grooved, long side rounded

Grooved corner left, rounded



Grooved corner right, rounded

			59630	59639	59637	59638		Model number	
			25 x 15.6 / 10 x 6 1/4	12.5 x 15.6 / 5 x 6 1/4	25 x 15.6 / 10 x 6 1/4	25 x 15.6 / 10 x 6 1/4		Nom. dim. - cm/in	
			244 x 150 x 15 mm	119 x 150 x 15 mm	244 x 150 x 15 mm	244 x 150 x 15 mm		Work size	
			4.000	8.000	4.000	4.000		m - pieces	
			1.000	0.490	1.000	1.000		Pieces - kg	
			18	36	18	18		Bundle - pieces	
			4.500	4.500	4.500	4.500		Bundle - m	
			18.000	17.640	18.000	18.000		Bundle - kg	
			Alb	Alb	Alb	Alb		Product standard	
			-/C	-/C	-/C	-/C		Slip resistance	
			553001-59630	553001-59639	553001-59637	553001-59638		900 grey-beige	
			Price gr. A438 (pce.)	Price gr. A423 (pce.)	Price gr. A449 (pce.)	Price gr. A449 (pce.)		553001 active azure <input type="checkbox"/>	
			553002-59630	553002-59639	553002-59637	553002-59638		900 grey-beige	
			Price gr. A438 (pce.)	Price gr. A423 (pce.)	Price gr. A449 (pce.)	Price gr. A449 (pce.)		553002 light azure <input type="checkbox"/>	
			340-59630	340-59639	340-59637	340-59638		900 grey-beige	
			Price gr. A438 (pce.)	Price gr. A423 (pce.)	Price gr. A449 (pce.)	Price gr. A449 (pce.)		340 n1/black <input type="checkbox"/>	
			900567-59630	900567-59639	900567-59637	900567-59638		91 n10/white	
			Price gr. A480 (pce.)	Price gr. A445 (pce.)	Price gr. A506 (pce.)	Price gr. A506 (pce.)		553001 active azure <input type="checkbox"/>	
			900588-59630	900588-59639	900588-59637	900588-59638		91 n10/white	
			Price gr. A480 (pce.)	Price gr. A445 (pce.)	Price gr. A506 (pce.)	Price gr. A506 (pce.)		553002 light azure <input type="checkbox"/>	
			900044-59630	900044-59639	900044-59637	900044-59638		91 n10/white	
			Price gr. A480 (pce.)	Price gr. A445 (pce.)	Price gr. A506 (pce.)	Price gr. A506 (pce.)		340 n1/black <input type="checkbox"/>	

 The products shown on this page can also be produced in other colors of the series Chroma and Chroma non-slip. We will be pleased to check the possibility of such a special production upon request.

No pallet rebate is granted for the products shown on this page.



Rounded corners				
Replace last figure 0 of standard model no. by 7 = corner left	... 8 = corner right	rounded corners	Example: Standard model no. 59620 = 119 x 244 x 15 mm, Model no. 59627 = rounded corner left



WT. 2.2



Ceramic specialists

The construction of swimming pools requires some very special solutions which cannot be used in any other area of application and which a premium supplier of swimming pool ceramics should have in its product range in order to cover the full spectrum of requirements of swimming pool architecture with a holistic programme. This includes stair tread tiles for pool ladders, letter tiles for indicating pool depths or for marking non-swimmer sections, or gutter tiles for the drainage of areas. All these special tiles are details, which can be found in almost every swimming pool and which would otherwise only be realizable by changing the material, e.g. to stainless steel.

Solebad, Werne, Germany / Architect: Geising + Böker GmbH /
Series: Pool edge system Finland, Chroma, Quarzit / Photo: Jochen Stüber

Stair Tiles with non-slip safety marking



25 x 12.5 cm



Stair tread,
long side rounded

12.5 x 12.5 cm



"Half-size" stair tread,
long side rounded

25 x 12.5 cm



Stair tread,
corner left, rounded

25 x 12.5 cm

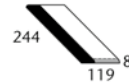

Stair tread,
corner right, rounded

Model number	34166H	34169H	34167H	34168H			
Nom. dim. - cm/in	25 x 12.5 / 10 x 5	12.5 x 12.5 / 5 x 5	25 x 12.5 / 10 x 5	25 x 12.5 / 10 x 5			
Work size	244 x 119 x 8 mm	119 x 119 x 8 mm	244 x 119 x 8 mm	244 x 119 x 8 mm			
m - pieces	4.000	8.000	4.000	4.000			
Pieces - kg	0.490	0.240	0.490	0.490			
Bundle - pieces	33	66	33	33			
Bundle - m	8.250	8.250	8.250	8.250			
Bundle - kg	16.170	15.840	16.170	16.170			
Product standard	Alb	Alb	Alb	Alb			
Slip resistance	-/C	-/C	-/C	-/C			
81 n10/white	900568-34166H	900568-34169H	900568-34167H	900568-34168H			
554001 active azure	Price gr. A445 (pce.)	Price gr. A425 (pce.)	Price gr. A456 (pce.)	Price gr. A456 (pce.)			
81 n10/white	900671-34166H	900671-34169H	900671-34167H	900671-34168H			
554002 light azure	Price gr. A445 (pce.)	Price gr. A425 (pce.)	Price gr. A456 (pce.)	Price gr. A456 (pce.)			
81 n10/white	900634-34166H	900634-34169H	900634-34167H	900634-34168H			
554111 n1/black	Price gr. A445 (pce.)	Price gr. A425 (pce.)	Price gr. A456 (pce.)	Price gr. A456 (pce.)			



Stair Tiles with non-slip safety marking



25 x 15.6 cm



Stair tread,
long side rounded

12.5 x 15.6 cm



"Half-size" stair tread,
long side rounded

25 x 15.6 cm

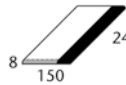

Stair tread,
corner left, rounded

25 x 15.6 cm

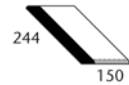

Stair tread,
corner right, rounded

Model number	34136H	34139H	34137H	34138H			
Nom. dim. - cm/in	25 x 15.6 / 10 x 6 1/4	12.5 x 15.6 / 5 x 6 1/4	25 x 15.6 / 10 x 6 1/4	25 x 15.6 / 10 x 6 1/4			
Work size	244 x 150 x 8 mm	119 x 150 x 8 mm	244 x 150 x 8 mm	244 x 150 x 8 mm			
m - pieces	4.000	8.000	4.000	4.000			
Pieces - kg	0.620	0.300	0.620	0.620			
Bundle - pieces	33	66	33	33			
Bundle - m	8.250	8.250	8.250	8.250			
Bundle - kg	20.460	19.800	20.460	20.460			
Product standard	Alb	Alb	Alb	Alb			
Slip resistance	-/C	-/C	-/C	-/C			
81 n10/white	900568-34136H	900568-34139H	900568-34137H	900568-34138H			
554001 active azure	Price gr. A452 (pce.)	Price gr. A428 (pce.)	Price gr. A467 (pce.)	Price gr. A467 (pce.)			
81 n10/white	900671-34136H	900671-34139H	900671-34137H	900671-34138H			
554002 light azure	Price gr. A452 (pce.)	Price gr. A428 (pce.)	Price gr. A467 (pce.)	Price gr. A467 (pce.)			
81 n10/white	900634-34136H	900634-34139H	900634-34137H	900634-34138H			
554111 n1/black	Price gr. A452 (pce.)	Price gr. A428 (pce.)	Price gr. A467 (pce.)	Price gr. A467 (pce.)			



No pallet rebate is granted for the products shown on this page.



The products shown on this page can also be produced in other colors of the series Chroma and Chroma non-slip. We will be pleased to check the possibility of such a special production upon request.

Rounded corners



Replace last figure 0 of standard model no. by ...

... 7 = corner left

... 8 = corner right

rounded corners

Example: Standard model no. 34166 = 119 x 244 x 15 mm,
Model no. 34167 = rounded corner left

E.g. for standing steps, ladder recesses, small radii, turning surfaces etc.

25 x 12.5 cm	12.5 x 6.2 cm ²	25 x 15.6 cm	25 x 15.6 cm	25 x 15.6 cm	25 x 15.6 cm	25 x 15.6 cm	
<i>Ripple tile</i>	<i>Strip tile</i>	<i>Short side rounded</i>	<i>Long side rounded</i>	<i>Corner left, rounded</i>	<i>Corner right, rounded</i>		
34170H	34070H	34120H	34125H	34126H	34127H	34128H	Model number
25 x 12.5 / 10 x 5	12.5 x 6.2 / 5 x 2 1/2	25 x 15.6 / 10 x 6 1/4	25 x 15.6 / 10 x 6 1/4	25 x 15.6 / 10 x 6 1/4	25 x 15.6 / 10 x 6 1/4	25 x 15.6 / 10 x 6 1/4	Nom. dim. - cm/in
244 x 119 x 8 mm	119 x 56 x 8 mm	244 x 150 x 8 mm	244 x 150 x 8 mm	244 x 150 x 8 mm	244 x 150 x 8 mm	244 x 150 x 8 mm	Work size
32.000/m ²	128.000/m ²	25.000/m ²	6.410/m	4.000/m	0.620	0.620	m ² /m - pieces
0.460	0.120	0.620	0.620	0.620	0.620	0.620	Pieces - kg
33	132	33	33	33	33	33	Pieces - pieces
1.031 m ²	1.031 m ²	1.320 m ²	5.148 m	8.250 m			Bundle - m ² /m
15.180	15.840	20.460	20.460	20.460	20.460	20.460	Bundle - kg
Alb	Alb	Alb	Alb	Alb	Alb	Alb	Product standard
	see below	see below	see below	see below	see below	see below	Slip resistance
700i-34170H	700i-34070H	700i-34120H	700i-34125H	700i-34126H	700i-34127H	700i-34128H	4 neutral 10 (active (white glossy)) <input type="checkbox"/>
Price gr. A304 (m ²)	Price gr. A244 (m ²)	Price gr. A211 (m ²)	Price gr. A416 (pce.)	Price gr. A416 (pce.)	Price gr. A423 (pce.)	Price gr. A423 (pce.)	
701i-34170H	701i-34070H	701i-34120H	701i-34125H	701i-34126H	701i-34127H	701i-34128H	4 neutral 10 (active (white matt)) <input type="checkbox"/>
Price gr. A304 (m ²)	Price gr. A244 (m ²)	Price gr. A211 (m ²)	Price gr. A416 (pce.)	Price gr. A416 (pce.)	Price gr. A423 (pce.)	Price gr. A423 (pce.)	
552001-34170H	552001-34070H	552001-34120H	552001-34125H	552001-34126H	552001-34127H	552001-34128H	2 active azure <input type="checkbox"/>
Price gr. A337 (m ²)	Price gr. A277 (m ²)	Price gr. A250 (m ²)	Price gr. A419 (pce.)	Price gr. A419 (pce.)	Price gr. A425 (pce.)	Price gr. A425 (pce.)	
552002-34170H	552002-34070H	552002-34120H	552002-34125H	552002-34126H	552002-34127H	552002-34128H	4 light azure <input type="checkbox"/>
Price gr. A337 (m ²)	Price gr. A277 (m ²)	Price gr. A250 (m ²)	Price gr. A419 (pce.)	Price gr. A419 (pce.)	Price gr. A425 (pce.)	Price gr. A425 (pce.)	
5716i-34170H¹	5716i-34070H¹	5716i-34120H¹	5716i-34125H¹	5716-34126H¹	5716i-34127H¹	5716i-34128H¹	1 neutral 1 (deep black) <input type="checkbox"/>
Price gr. A346 (m ²)	Price gr. A277 (m ²)	Price gr. A250 (m ²)	Price gr. A419 (pce.)	Price gr. A419 (pce.)	Price gr. A425 (pce.)	Price gr. A425 (pce.)	
	-/B <input type="checkbox"/>	-/B <input type="checkbox"/>	-/B <input type="checkbox"/>	-/B <input type="checkbox"/>	-/B <input type="checkbox"/>	-/B <input type="checkbox"/>	
	91i-34070H	91i-34120H	91i-34125H	91i-34126H	91i-34127H	91i-34128H	neutral 10 (active white) <input type="checkbox"/>
	Price gr. A289 (m ²)	Price gr. A256 (m ²)	Price gr. A423 (pce.)	Price gr. A423 (pce.)	Price gr. A428 (pce.)	Price gr. A428 (pce.)	
	-/B <input type="checkbox"/>	-/B <input type="checkbox"/>	-/B <input type="checkbox"/>	-/B <input type="checkbox"/>	-/B <input type="checkbox"/>	-/B <input type="checkbox"/>	
	553001-34070H	553001-34120H	553001-34125H	553001-34126H	553001-34127H	553001-34128H	active azure <input type="checkbox"/>
	Price gr. A298 (m ²)	Price gr. A265 (m ²)	Price gr. A425 (pce.)	Price gr. A425 (pce.)	Price gr. A430 (pce.)	Price gr. A430 (pce.)	
	-/B <input type="checkbox"/>	-/B <input type="checkbox"/>	-/B <input type="checkbox"/>	-/B <input type="checkbox"/>	-/B <input type="checkbox"/>	-/B <input type="checkbox"/>	
	553002-34070H	553002-34120H	553002-34125H	553002-34126H	553002-34127H	553002-34128H	light azure <input type="checkbox"/>
	Price gr. A298 (m ²)	Price gr. A265 (m ²)	Price gr. A425 (pce.)	Price gr. A425 (pce.)	Price gr. A430 (pce.)	Price gr. A430 (pce.)	
	-/B <input type="checkbox"/>	-/B <input type="checkbox"/>	-/B <input type="checkbox"/>	-/B <input type="checkbox"/>	-/B <input type="checkbox"/>	-/B <input type="checkbox"/>	
	340i-34070H	340i-34120H	340i-34125H	340-34126	340i-34127H	340i-34128H	neutral 1 (deep black) <input type="checkbox"/>
	Price gr. A298 (m ²)	Price gr. A265 (m ²)	Price gr. A425 (pce.)	Price gr. A425 (pce.)	Price gr. A430 (pce.)	Price gr. A430 (pce.)	



Safety Strip Tiles

(especially suitable for slip-resistant and clearly visible (stair) edge design)

25 x 6.2 cm	12.5 x 6.2 cm	25 x 6.2 cm	25 x 6.2 cm	
<i>Grooved long side rounded</i>	<i>"Half-size" tile grooved, long side rounded</i>	<i>Grooved Corner left, rounded</i>	<i>Grooved Corner right, rounded</i>	
34306	34309	34307	34308	Model number
25 x 6.2 / 10 x 2 1/2	12.5 x 6.2 / 5 x 2 1/2	25 x 6.2 / 10 x 2 1/2	25 x 6.2 / 10 x 2 1/2	Nom. dim. - cm/in
244 x 56 x 8 mm	119 x 56 x 8 mm	244 x 56 x 8 mm	244 x 56 x 8 mm	Work size
4.000	8.000	4.000	4.000	m - pieces
0.200	0.100	0.200	0.200	Pieces - kg
66	132	66	66	Pieces - pieces
16.500	16.500	16.500	16.500	Bundle - pieces
13.200	13.200	13.200	13.200	Bundle - m
Alb	Alb	Alb	Alb	Bundle - kg
-/C <input type="checkbox"/>	-/C <input type="checkbox"/>	-/C <input type="checkbox"/>	-/C <input type="checkbox"/>	Product standard
91-34306	91-34309	91-34307	91-34308	Slip resistance
Price gr. A431 (pce.)	Price gr. A416 (pce.)	Price gr. A434 (pce.)	Price gr. A434 (pce.)	neutral 10 (active white) <input type="checkbox"/>
553001-34306	553001-34309	553001-34307	553001-34308	active azure <input type="checkbox"/>
Price gr. A434 (pce.)	Price gr. A418 (pce.)	Price gr. A438 (pce.)	Price gr. A438 (pce.)	
553002-34306	553002-34309	553002-34307	553002-34308	light azure <input type="checkbox"/>
Price gr. A434 (pce.)	Price gr. A418 (pce.)	Price gr. A438 (pce.)	Price gr. A438 (pce.)	
340-34306	340-34309	340-34307	340-34308	neutral 1 (deep black) <input type="checkbox"/>
Price gr. A434 (pce.)	Price gr. A418 (pce.)	Price gr. A438 (pce.)	Price gr. A438 (pce.)	



The products shown on this page can also be produced in other colors of the series Chroma and Chroma non-slip. We will be pleased to check the possibility of such a special production upon request.

¹ For reasons of production, differences in color between special pieces and standard tiles can occur.

² Strip tile, supplied as quadruple strip tile; to be broken by customer
No pallet rebate is granted for the products shown on this page.



Stair Tread Tiles, tread unglazed in 900 grey-beige, grooved

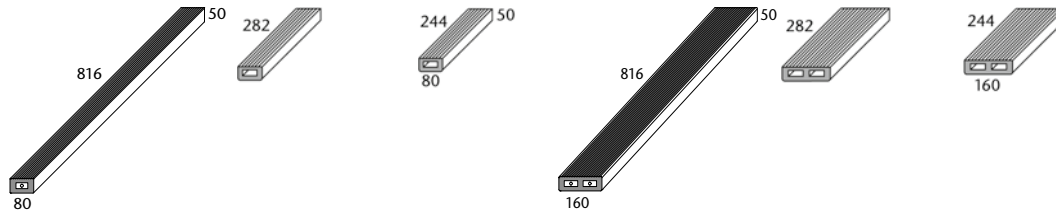

	Stair tread tile	Stair tread tile	Stair tread tile	Stair tread tile	Stair tread tile	Stair tread tile
Model number	55561 ²	55565 ¹	55563 ¹	55562 ²	55567 ¹	55566 ¹
Nom. dim. - cm/in						
Work size mm	816 x 80 x 50	282 x 80 x 50	244 x 80 x 50	816 x 160 x 50	282 x 160 x 50	244 x 160 x 50
m - pieces						
Pieces - kg	7.387	1.830	1.600	14.883	3.500	3.150
Bundle - pieces	2	9	10	1	4	5
Bundle - kg	14.774	16.470	16.000	14.883	14.000	15.750
Product standard	Alb	Alb	Alb	Alb	Alb	Alb
Slip resistance	-/C	-/C	-/C	-/C	-/C	-/C
900 grey-beige	700-55561	700-55565	700-55563	700-55562	700-55567	700-55566
700 n10/white gl. <input type="checkbox"/>	Price gr. A683 (pce.)	Price gr. A593 (pce.)	Price gr. A581 (pce.)	Price gr. A705 (pce.)	Price gr. A708 (pce.)	Price gr. A698 (pce.)
900 grey-beige	701-55561	701-55565	701-55563	701-55562	701-55567	701-55566
701 n10/white matt <input type="checkbox"/>	Price gr. A683 (pce.)	Price gr. A593 (pce.)	Price gr. A581 (pce.)	Price gr. A705 (pce.)	Price gr. A708 (pce.)	Price gr. A698 (pce.)
900 grey-beige	552001-55561	552001-55565	552001-55563	552001-55562	552001-55567	552001-55566
552001 active azure <input type="checkbox"/>	Price gr. A683 (pce.)	Price gr. A601 (pce.)	Price gr. A587 (pce.)	Price gr. A705 (pce.)	Price gr. A716 (pce.)	Price gr. A708 (pce.)
900 grey-beige	552002-55561	552002-55565	552002-55563	552002-55562	552002-55567	552002-55566
552002 light azure <input type="checkbox"/>	Price gr. A683 (pce.)	Price gr. A601 (pce.)	Price gr. A587 (pce.)	Price gr. A705 (pce.)	Price gr. A716 (pce.)	Price gr. A708 (pce.)
900 grey-beige	5716-55561³	5716-55565³	5716-55563³	5716-55562³	5716-55567³	5716-55566³
5716 n1/black <input type="checkbox"/>	Price gr. A683 (pce.)	Price gr. A601 (pce.)	Price gr. A587 (pce.)	Price gr. A705 (pce.)	Price gr. A716 (pce.)	Price gr. A708 (pce.)



Letter Tiles

25 x 12.5 cm



25 x 25 cm

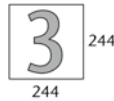

25 x 12.5 cm



Shank-tile (as connecting piece between cover grating and pool surround)

25 x 12.5 cm

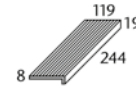

12.5 x 12.5 cm



	Number tile Type height 7 cm	Number tile Type height 20 cm	Letter tiles Type height 7 cm	Shank-tile grooved	„Half size“ shank-tile grooved
Model number	38119	32059	S10002	37150	37155
Nom. dim. - cm/in	25 x 12.5 / 10 x 5	25 x 25 / 10 x 10	25 x 12.5 / 10 x 5	25 x 12.5 / 10 x 5	12.5 x 12.5 / 5 x 5
Work size mm	244 x 119 x 8	244 x 244 x 8	244 x 119 x 8	244 x 119/19 x 8	119 x 119/19 x 8
m - pieces			4.000	4.000	8.000
Pieces - kg	0.490	1.060	0.490	2.000	2.000
Bundle - pieces				20	40
Bundle - m				5.000	5.000
Bundle - kg				10.000	10.000
Product standard	Alb	Alb	Alb	Alb	Alb
Slip resistance			-/B	-/C	-/C
700 n10/white gl. <input type="checkbox"/>	900659-38119	900659-32059			
552001 active azure <input type="checkbox"/>	Price gr. A587 (pce.)	Price gr. A601 (pce.)			
701 n10/white matt <input type="checkbox"/>	900672-38119	900672-32059			
552001 active azure <input type="checkbox"/>	Price gr. A587 (pce.)	Price gr. A601 (pce.)			
700 n10/white gl. <input type="checkbox"/>	900673-38119	900673-32059			
5716 n1/black <input type="checkbox"/>	Price gr. A587 (pce.)	Price gr. A601 (pce.)			
701 n10/white matt <input type="checkbox"/>	900644-38119	900644-32059			
5716 n1/black <input type="checkbox"/>	Price gr. A587 (pce.)	Price gr. A601 (pce.)			
91 n10/white <input type="checkbox"/>			900567-S10002		
552001 active azure <input type="checkbox"/>			Price gr. A649 (pce.)		
91 n10/white <input type="checkbox"/>			900044-S10002		
340 n1/black <input type="checkbox"/>			Price gr. A649 (pce.)		
grey-beige <input type="checkbox"/>				900-37150	900-37155
neutral 10 / white <input type="checkbox"/>				Price gr. A434 (pce.)	Price gr. A419 (pce.)
				91-37150	91-37155
				Price gr. A438 (pce.)	Price gr. A428 (pce.)



¹ In the case of these special pieces, the tread is unglazed in 900; all other surfaces are in the respective Chroma color.

² Prefabricated tread, cast, inclusive of reinforcement. In the case of this special piece, the tread and the back side are unglazed 900; the front and the lower side are glazed in the respective Chroma color.

³ For reasons of production, differences in color between special pieces and standard tiles can occur.

No pallet rebate is granted for the products shown on this page.



The products shown on this page can also be produced in other colors of the series Chroma and Chroma non-slip. We will be pleased to check the possibility of such a special production upon request.

Shank-Tiles (as support for cover gratings)¹

25 x 12.5 cm

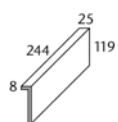

12.5 x 12.5 cm



25 x 12.5 cm

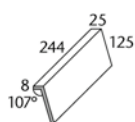

12.5 x 12.5 cm



25 x 3.3 cm

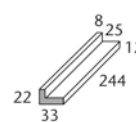

12.5 x 3.3 cm

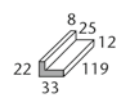

Shank-tile	„Half-size“ shank-tile	inclined shank-tile	„Hal size“ inclined shank-tile	Supporting angle for grating	„Half-size“ supporting angle for grating	
37011	37015	37017	37018	37031	37035	Model number
25 x 12.5 / 10 x 5	12.5 x 12.5 / 5 x 5	25 x 12.5 / 10 x 5	12.5 x 12.5 / 5 x 5	25 x 3.3 / 10 x 1 3/8	12.5 x 3.3 / 5 x 1 3/8	Nom. dim. - cm/in
244 x 119/25 x 8	119 x 119/25 x 8	244 x 125/25 x 8	119 x 125/25 x 8	244 x 33/22 x 8	119 x 33/22 x 8	Work size mm
4.000	8.000	4.000	8.000	4.000	8.000	m - pieces
0.600	0.290	0.620	0.300	0.200	0.100	Pieces - kg
16	32	16	32	72	144	Bundle - pieces
4.000	4.000	4.000	4.000	18.000	18.000	Bundle - m
9.600	9.280	9.920	9.600	14.400	14.400	Bundle - kg
Alb	Alb	Alb	Alb	Alb	Alb	Product standard
700-37011	700-37015	700-37017	700-37018	700-37031	700-37035	neutral 10 (active
Price gr. A445 (pce.)	Price gr. A423 (pce.)	Price gr. A452 (pce.)	Price gr. A425 (pce.)	Price gr. A445 (pce.)	Price gr. A425 (pce.)	(white glossy) <input type="checkbox"/>
701-37011	701-37015	701-37017	701-37018	701-37031	701-37035	neutral 10 (active
Price gr. A445 (pce.)	Price gr. A423 (pce.)	Price gr. A452 (pce.)	Price gr. A425 (pce.)	Price gr. A445 (pce.)	Price gr. A425 (pce.)	(white matt) <input type="checkbox"/>



Coved Gutter Tiles

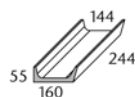

Coved gutter tile inside width 144 mm

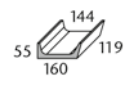

„Half-size“ coved gutter tile



Coved gutter tile with outlet (ø 100 mm)²



Art. no. 59680

				59680	59685	59681	
				244 x 160 x 55/15	119 x 160 x 55/15	244 x 160 x 55/15	Model number
				4.000	8.000		Nom. dim. - cm/in
				1.700	0.850	1.550	Work size mm
				4	8	4	m - pieces
				1.000	1.000		Pieces - kg
				6.800	6.800	6.200	Bundle - pieces
				Alb	Alb	Alb	Bundle - m
				700-59680	700-59685	700-59681	Bundle - kg
				Price gr. A489 (pce.)	Price gr. A449 (pce.)	Price gr. A560 (pce.)	Product standard
				701-59680	701-59685	701-59681	neutral 10 (active
				Price gr. A489 (pce.)	Price gr. A449 (pce.)	Price gr. A560 (pce.)	(white glossy) <input type="checkbox"/>
							neutral 10 (active
							(white matt) <input type="checkbox"/>

¹ For cover gratings, refer to page 84

² For the matching outlet valve "Silent W 2000", refer to page 86



The products shown on this page can also be produced in other colors of the series Chroma and Chroma non-slip. We will be pleased to check the possibility of such a special production upon request.

No pallet rebate is granted for the products shown on this page.

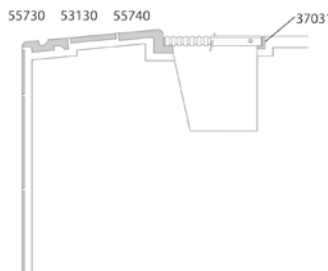
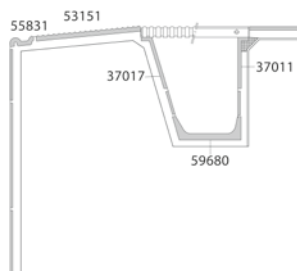
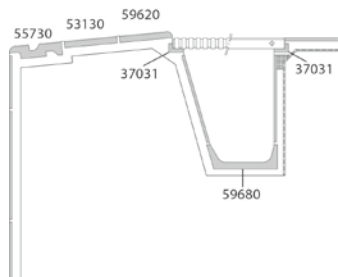

Gutter Tiles^{1/2/4} (trough depth 5 mm)



50 x 25 cm

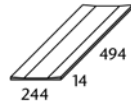

50 x 25 cm⁵

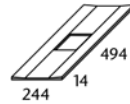

50 x 25 cm

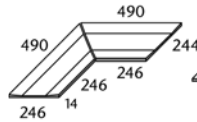

50 x 25 cm⁵

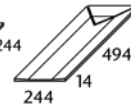

Art. no. 53320

Gutter tile

Gutter tile with Outlet
110 / 110 mm

Mitred pair

Terminal piece

Model number	53320	53321	53322	53323
Nom. dim. - cm/in	50 x 25 / 20 x 10	50 x 25 / 20 x 10	50 x 25 / 20 x 10	50 x 25 / 20 x 10
Work size mm	494 x 244 x 14	494 x 244 x 14	(2x) 490 x 244 x 14	494 x 244 x 14
m - pieces	2.000	2.000	2.000	2.000
Pce./pair - kg	2.500/piece	2.300/piece	3.800/pair	2.500/piece
Bundle - pce./pair	5 pieces	5 pieces	2 pairs	5 pieces
Bundle - m	2.500	2.300	7.600	2.500
Bundle - kg	12.500	11.500	7.600	12.500
Product standard	Alb ⁶	Alb ⁶	Alb ⁶	Alb ⁶
Slip resistance	see below	see below	see below	see below
	-/B	-/B	-/B	-/B
neutral 10 (white) ³	91-53320H Price gr. A514 (pce.)	91-53321H Price gr. A587 (pce.)	91-53322H Price gr. A638 (pair)	91-53323H Price gr. A587 (pce.)
	-/B	-/B	-/B	-/B
light azure ³	553002-53320H Price gr. A519 (pce.)	553002-53321H Price gr. A593 (pce.)	553002-53322H Price gr. A645 (pair)	553002-53323H Price gr. A593 (pce.)
Area Pro anthracite	R11/B 435637H Price gr. A519 (pce.)	R11/B 435649H Price gr. A593 (pce.)	R11/B 435661H Price gr. A645 (pair)	R11/B 435673H Price gr. A593 (pair)
Area Pro basalt	R11/B 435638 Price gr. A519 (pce.)	R11/B 435650 Price gr. A593 (pce.)	R11/B 435662 Price gr. A645 (pair)	R11/B 435674 Price gr. A593 (pair)
Area Pro pebble	R11/B 435639 Price gr. A519 (pce.)	R11/B 435651 Price gr. A593 (pce.)	R11/B 435663 Price gr. A645 (pair)	R11/B 435675 Price gr. A593 (pair)
Area Pro stone	R11/B 435640 Price gr. A519 (pce.)	R11/B 435652 Price gr. A593 (pce.)	R11/B 435664 Price gr. A645 (pair)	R11/B 435676 Price gr. A593 (pair)
Area Pro sand-white	R11/B 435641 Price gr. A519 (pce.)	R11/B 435653 Price gr. A593 (pce.)	R11/B 435665 Price gr. A645 (pair)	R11/B 435677 Price gr. A593 (pair)
Area Pro sand-grey	R11/B 435642 Price gr. A519 (pce.)	R11/B 435654 Price gr. A593 (pce.)	R11/B 435666 Price gr. A645 (pair)	R11/B 435678 Price gr. A593 (pair)
Area Pro sand	R11/B 435643 Price gr. A519 (pce.)	R11/B 435655 Price gr. A593 (pce.)	R11/B 435667 Price gr. A645 (pair)	R11/B 435679 Price gr. A593 (pair)
Area Pro nutmeg	R11/B 435644 Price gr. A519 (pce.)	R11/B 435656 Price gr. A593 (pce.)	R11/B 435668 Price gr. A645 (pair)	R11/B 435680 Price gr. A593 (pair)
Area Pro platinum	R11/B 435645 Price gr. A519 (pce.)	R11/B 435657 Price gr. A593 (pce.)	R11/B 435669 Price gr. A645 (pair)	R11/B 435681 Price gr. A593 (pair)
Area Pro sand-beige	R11/B 435646 Price gr. A519 (pce.)	R11/B 435658 Price gr. A593 (pce.)	R11/B 435670 Price gr. A645 (pair)	R11/B 435682 Price gr. A593 (pair)
Area Pro brick	R11/B 435647 Price gr. A519 (pce.)	R11/B 435659 Price gr. A593 (pce.)	R11/B 435671 Price gr. A645 (pair)	R11/B 435683 Price gr. A593 (pair)
Area Pro clay	R11/B 435648 Price gr. A519 (pce.)	R11/B 435660 Price gr. A593 (pce.)	R11/B 435672 Price gr. A645 (pair)	R11/B 435684 Price gr. A593 (pair)

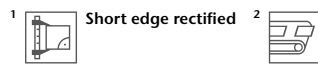

³ Also available as special production in the series Chroma non-slip or Chroma unglazed - Quantum.
⁴ Also available in a length of 497 mm on request.
⁵ Minimum order quantity: 10 pieces. In case of smaller quantities, the price must be individually calculated.
⁶ All articles of the series Area Pro comply with the product standard DIN EN 14411, group Al_a, unglazed (UGL)

Gutter Tiles^{1/2/3} (trough depth 5 mm)

50 x 25 cm

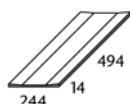

50 x 25 cm⁴

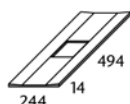

50 x 25 cm

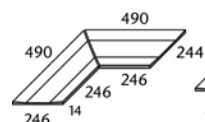

50 x 25 cm⁴



Art. no. 53320

		Gutter tile	Gutter tile with Outlet 110 / 110 mm	Mitred pair	Terminal piece	Art. no. 53320
		53320	53321	53322	53323	Model number
		50 x 25 / 20 x 10	50 x 25 / 20 x 10		50 x 25 / 20 x 10	Nom. dim. - cm/in
		494 x 244 x 14	494 x 244 x 14	(2x) 490 x 244 x 14	494 x 244 x 14	Work size mm
		2.000				m - pieces
		2.500/piece	2.300/piece	3.800/pair	2.500/piece	Pce./pair - kg
		5 pieces	5 pieces	2 pairs	5 pieces	Bundle - pce./pair
		2.500				Bundle - m
		12.500	11.500	7.600	12.500	Bundle - kg
		Ala	Ala	Ala	Ala	Product standard
		R11/B	R11/B	R11/B	R11/B	Slip resistance
		430810H	430814H	430818H	430822H	Ascona
		Price gr. A519 (pce.)	Price gr. A593 (pce.)	Price gr. A645 (pair)	Price gr. A593 (pce.)	pearl V3
		430811H	430815H	430819H	430823H	Ascona
		Price gr. A519 (pce.)	Price gr. A593 (pce.)	Price gr. A645 (pair)	Price gr. A593 (pce.)	mud V3
		430812H	430816H	430820H	430824H	Ascona
		Price gr. A519 (pce.)	Price gr. A593 (pce.)	Price gr. A645 (pair)	Price gr. A593 (pce.)	stone V3
		430813H	430817H	430821H	430825H	Ascona
		Price gr. A519 (pce.)	Price gr. A593 (pce.)	Price gr. A645 (pair)	Price gr. A593 (pce.)	graphite V3
		431559H	431561H	431563H	431565H	Ascona
		Price gr. A519 (pce.)	Price gr. A593 (pce.)	Price gr. A645 (pair)	Price gr. A593 (pce.)	shell V3
		431560H	431562H	431564H	431566H	Ascona
		Price gr. A519 (pce.)	Price gr. A593 (pce.)	Price gr. A645 (pce.)	Price gr. A593 (pce.)	sand V3
		8460-53320H	8460-53321H	8460-53322H	8460-53323H	Quarzit
		Price gr. A519 (pce.)	Price gr. A593 (pce.)	Price gr. A645 (pair)	Price gr. A593 (pce.)	basalt-grey V4
		8461-53320H	8461-53321H	8461-53322H	8461-53323H	Quarzit
		Price gr. A519 (pce.)	Price gr. A593 (pce.)	Price gr. A645 (pair)	Price gr. A593 (pce.)	quarz-grey V4
		8462-53320H	8462-53321H	8462-53322H	8462-53323H	Quarzit
		Price gr. A519 (pce.)	Price gr. A593 (pce.)	Price gr. A645 (pair)	Price gr. A593 (pce.)	sand-beige V4
		8463-53320H	8463-53321H	8463-53322H	8463-53323H	Quarzit
		Price gr. A519 (pce.)	Price gr. A593 (pce.)	Price gr. A645 (pair)	Price gr. A593 (pce.)	sepia-brown V4
		8464-53320H	8464-53321H	8464-53322H	8464-53323H	Quarzit
		Price gr. A519 (pce.)	Price gr. A593 (pce.)	Price gr. A645 (pair)	Price gr. A593 (pce.)	white-grey V4



Short edge rectified



³ Can also be produced in a length of 497 mm on request.

⁴ Minimum order quantity: 10 pieces. In case of smaller quantities, the price must be individually calculated.

Gutter Tiles (trough depth 15 mm)

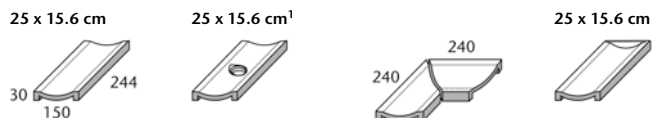

Art. no. 54420

	Gutter tile	Gutter tile with outlet 1 1/2"	Mitred pair	Terminal piece			
Model number	54420	54421	54422	54423			
Nom. dim. - cm/in	25 x 15,6 / 10 x 6 1/4	25 x 15,6 / 10 x 6 1/4		25 x 15,6 / 10 x 6 1/4			
Work size mm	244 x 150 x 30	244 x 150 x 30	(2x) 240 x 150 x 30	244 x 150 x 30			
m - pieces	4.000						
Pce./pair - kg	1.800/piece	1.530/piece	3.030/pair	1.950/piece			
Bundle - pce./pair	8 pieces	8 pieces	4 pairs	8 pieces			
Bundle - m	2.000						
Bundle - kg	14.400	12.240	12.120	15.600			
Product standard	Alb	Alb	Alb	Alb			
Slip resistance	see below	see below	see below	see below			
	R10/A	R10/A	R10/A	R10/A			
	900-54420²	900-54421²	900-54422²	900-54423²			
grey-beige	Price gr. A458 (pce.)	Price gr. A560 (pce.)	Price gr. A581 (pair)	Price gr. A560 (pce.)			
	R11/B	R11/B	R11/B	R11/B			
	902R-54420²	902R-54421²	902R-54422²	902R-54423²			
grey-white	Price gr. A458 (pce.)	Price gr. A560 (pce.)	Price gr. A581 (pair)	Price gr. A560 (pce.)			
	-/B	-/B	-/B	-/B			
	91-54420	91-54421	91-54422	91-54423			
neutral 10 (white)	Price gr. A475 (pce.)	Price gr. A577 (pce.)	Price gr. A601 (pair)	Price gr. A577 (pce.)			

¹ Fitting insert for the outlet: Article no. 182, see page 86 (installation prior to laying).

² These articles comply with DIN EN 14411, group Al_b, unglazed (UGL)

No pallet rebate is granted for the products shown on this page.

 The products shown on this page can also be produced in other colors of the series Chroma and Chroma non-slip. We will be pleased to check the possibility of such a special production upon request.

Bybadet, Alesund, Norway / Architect: Invit Arkitekter AS, Alesund, Norway / Photo: Tove Lauluten, Oslo





Around the pool

Expertise around the pool

Contemporary swimming pool architecture must satisfy high standards. And that not only in terms of design: sports pools, spas and private pools should be comfortable and safe, inexpensive to maintain, easy to clean and permanently hygienic.

Tiles meet these functional requirements: for example, with slip-resistant special surfaces which ensure a safe foothold even when wet. Modularly combinable tiles and special pieces are important for a consistent design from the pool and pool surround to all adjacent areas such as showers, saunas, changing rooms or restaurants.

As algae, moss and microbes feel very much at home in the warm and humid indoor climate of swimming pools, maintaining high hygiene standards often becomes a challenge. The proven Hytect technology of our ceramic tiles solves the problem. It has a permanent antibacterial effect, eliminates unpleasant odours and facilitates cleaning.

Quality ceramics forms the basis of convincing solutions in all the points mentioned above and is therefore superior to other materials such as metal or natural stone. This applies all the more to swimming pool ceramics from AGROB BUCHTAL, because every tile and every special piece contains the experience of decades in which the company has realized tens of thousands of the most diverse sports, leisure and therapy pools world-wide.

Paracelsus Bad & Kurhaus, Salzburg, Austria
Architect: Berger + Parkkinen / Series: Pool edge system Wiesbaden,
Savona / Photo: Fotodesign Peters, Amerang







Slip-resistant and stylish at the pool edge as well

There are special requirements with regard to accident prevention which have to be met by the pool surround. Anyone who walks barefoot on the usually wet pool edge must be protected against the risk of slipping. The tile series from AGROB BUCHTAL, available in XS to XXL formats, offer the legally required slip resistance for accident-free walking into and out of the pool. This is guaranteed by the special "GRIP quality seal". A wide range of different colors and surfaces opens up a great variety of design options.

Design concepts for swimming pools can be consistently realized with tiles from AGROB BUCHTAL at the pool surround as well. The AGROB BUCHTAL range offers a variety of products for small-sized solutions from mini to medium format. The range extends from XS formats (from 2.5 x 2.5 cm in the series Plural non-slip, Plural unglazed, Marble & More, Loop, Fresh) to a wide range of octametric formats of Chroma non-slip and Chroma unglazed through to the 60 x 120 cm large format of the Area Pro series. Decorative surfaces include a variety of series (Area Pro, Ascona, Basic Stone, Emotion, Marble & More, Nova, Quarzit, Savona, Valley).

Most of the products are available with joint widths of 3 and 6 mm. This allows the realization of harmonious transitions from the pool surround to the wider standard joint dimensions of the underwater area. Hytect and the Protecta surface upgrading (depending on the type of material) ensure a permanently attractive appearance and offer economic and ecological advantages thanks to easy cleaning.

The right edge for every pool

Not all baths are the same: different types of use of sports, leisure and adventure pools, therapy baths, private and hotel pools or sports and competition pools require different pool planning concepts. They all demand a sophisticated design of the pool and its surround. This works with modularly combinable components. Besides tiles for the surface, this also applies to ceramic pool edge systems or special pieces such as profiled edgings, skirtings and cove skirtings. They enable a consistent design of the pool wall, floor and edge.

Large formats with natural-looking surfaces are in demand for the pool surround. And tiles with different slip-resistance classes, which guarantee the legally required standard in swimming pools. An advantage which only high-quality ceramics can offer.

The series listed on the following pages are suitable for use in pool surrounds. Thanks to the variety of colors, formats and looks, they offer enormous architectural design freedom.

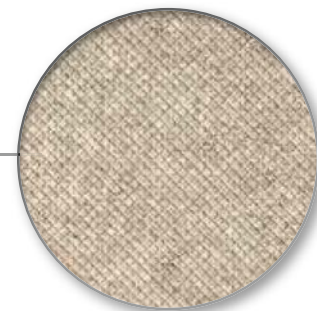

Grid profile

Chiemgau Thermen, Bad Endorf, Germany
 Architect: Architekturwerkstatt Zopf, Salzburg, Austria
 Series: Pool edge system Finnland,
 pool edge system St. Moritz, Quarzit
 Photo: Peters Fotodesign, Amerang

The grid profile of the series Ascona, Chroma unglazed and Quarzit is advantageous in two respects: it guarantees the required slip resistance in the pool surround area and at the same time conveys a pleasantly soft barefoot walking feeling. The embossed structure is particularly robust and durable. The finely processed mass gives these tiles a pleasantly velvety surface feel. The tiles give bathers a feeling of safety also visually, as their structure signals a slip-resistant surface.



Area Pro

For details, refer to the 2024 programme of delivery



Ascona

Details on page 135 and the following

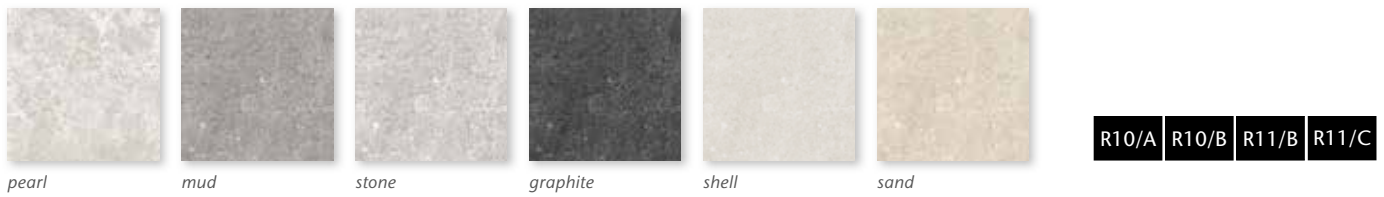

Nova

For details, refer to the 2024 programme of delivery

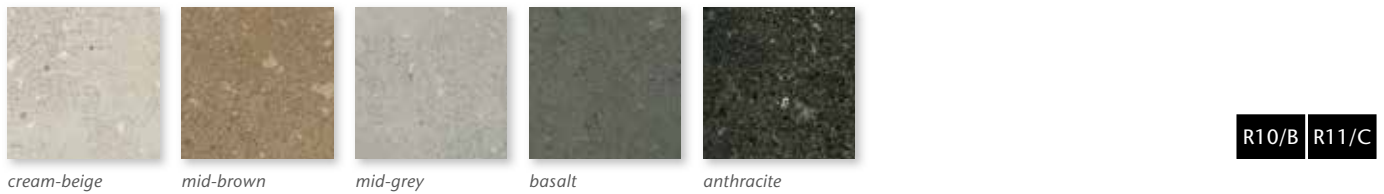

Quarzit

Details on page 209 and the following



Savona

Details on page 216



Valley

For details, refer to the 2024 programme of delivery





Emotion

For details, refer to the 2024 programme of delivery

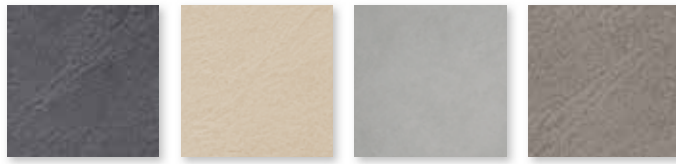

deep anthracite light-beige mid-grey basalt

R11/B

Basic Stone

For details, refer to the 2024 programme of delivery



black medium grey light grey mud beige

R10/B

Marble & More

For details, refer to the 2024 programme of delivery

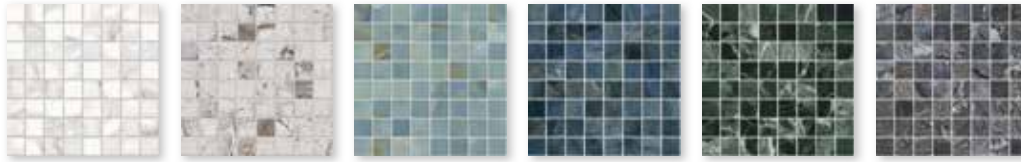

carrara white illusion beige cielo labradorit blue verde alpi illusion dark

R10/B

Fresh

Details on page 236

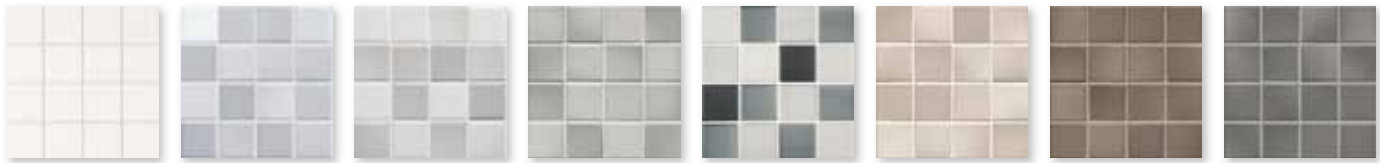

snow white silver grey mix warm grey mix light grey-mix white grey mix desert sand-mix taupe-mix medium grey-mix

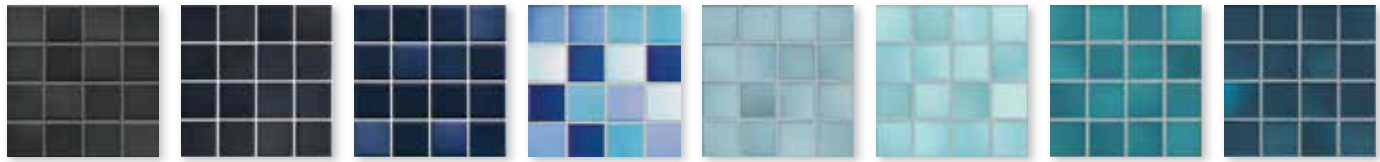

midnight black-mix graphite black mix deep blue mix caribbean blue mix denim blue-mix light blue-mix pacific blue-mix midnight blue-mix



vivid violet-mix sunset orange-mix coral red-mix brick red mix mystic red-mix forest green mix lime green-mix sunshine yellow-mix

R10/B R11/C

Loop

Details on page 246

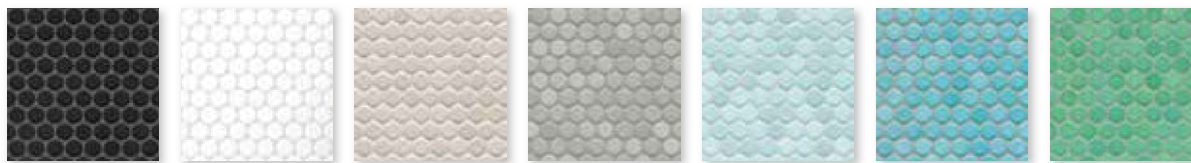

night black arctic white light ivory light diamond grey light aqua blue aqua blue sea green

R10/B



Chroma non-slip

Details on page 155 and the following

<i>neutral 1</i>	<i>neutral 2</i>	<i>neutral 3</i>	<i>neutral 4</i>	<i>neutral 5</i>	<i>neutral 6</i>	<i>neutral 7</i>	<i>neutral 8</i>
<i>neutral 9</i>	<i>neutral 10</i>	<i>active azure</i>	<i>light azure</i>	<i>medium azure</i>	<i>dark azure</i>	<i>light blue</i>	<i>medium blue</i>
<i>dark blue</i>	<i>light turquoise</i>	<i>medium turquoise</i>	<i>light green</i>	<i>medium green</i>	<i>dark green</i>	<i>light yellow</i>	<i>medium yellow</i>
<i>medium ochre</i>	<i>light salmon</i>	<i>medium salmon</i>	<i>medium oxide red</i>	<i>active stone grey</i>	<i>light stone grey</i>	<i>medium stone grey</i>	<i>dark stone grey</i>
<i>active sand grey</i>	<i>light sand grey</i>	<i>medium sand grey</i>	<i>dark sand grey</i>	<i>contrasting red</i>			

B

Chroma unglazed

Details on page 167

<i>neutral 1</i>	<i>neutral 3</i>	<i>neutral 7</i>	<i>neutral 8</i>	<i>neutral 10</i>		
<i>natural white</i>	<i>medium stone grey</i>	<i>dark stone grey</i>	<i>light sand grey</i>	<i>medium sand grey</i>	<i>dark sand grey</i>	<i>medium ochre</i>

R11/B



Plural non-slip

Details on page 194 and the following

neutral 1	neutral 2	neutral 3	neutral 4	neutral 5	neutral 6	neutral 7	neutral 8
neutral 9	neutral 10	active azure	light azure	medium azure	dark azure	active blue	light blue
medium blue	dark blue	active turquoise	light turquoise	medium turquoise	dark turquoise	active green	light green
medium green	dark green	active yellow	light yellow	medium yellow	dark yellow	active ochre	light ochre
medium ochre	dark ochre	active salmon	light salmon	medium salmon	dark salmon	active oxide red	light oxide red
medium oxide red	dark oxide red	active stone grey	light stone grey	medium stone grey	dark stone grey	active sand grey	light sand grey
medium sand grey	dark sand grey						

R10/B

Plural unglazed

Details on page 202 and the following

neutral 1	neutral 3	dark blue	dark green	medium ochre	active stone grey	sand-white	medium sand grey
dark sandgrey	medium brown	medium grey	medium sand beige				

R10/B R11/C



Havel-Therme, Werder (Havel), Germany / Architect: Geising & Böker GmbH Architekten BDA, Hamburg
Series: Fresh, Savona / Photo: Jochen Stüber







Experience diversity

Ascona is made for spas, wellness areas and swimming pools in hotels, but also for private homes. This is also due to the diversity of this series. Already visually, with mosaics and oblong formats, small and large formats for walls and floors as well as the fine selection of colors, one has a wide range for design. However, the series also impresses with its functional possibilities and technical solutions, especially for all swimming pool areas or spas – by the way, indoors and outdoors, in entrance areas as well as in rooms where visitors walk barefoot or in dedicated wet areas. Thanks to clear lines and grounded colors, a wide variety of style worlds can be created. Puristic architecture is just as possible as classic or modern country house designs. The Ascona series can be perfectly combined with our mosaic series Marble & More.

Rendering



R10/A R10/B R11/B R11/C



pearl



mud



stone

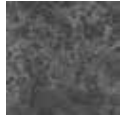

graphite

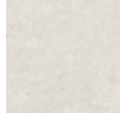

shell

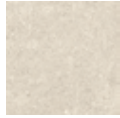

sand



Floor tile 15 x 15 cm, 6 x 6 in, structured, R10/B



Floor tile 25 x 50 cm, 10 x 20 in, structured, R11/B



Floor tile 30 x 60 cm, 12 x 24 in, structured, R10/A
Floor tile 30 x 60 cm, 12 x 24 in, structured, R11/B



Grid profile tile 25 x 50 cm, 10 x 20 in, relief, R11/C

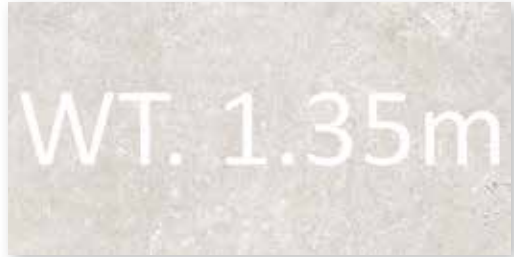

Letter tile 25 x 50 cm, 10 x 20 in, structured, R11/B

Mosaic 5 x 5 cm, 2 x 2 in



Mosaic sheet 30 x 30 cm, 2 x 2 in, pearl, structured, R10/B



Mosaic sheet 30 x 30 cm, 2 x 2 in, mud, structured, R10/B



Mosaic sheet 30 x 30 cm, 2 x 2 in, stone, structured, R10/B



Mosaic sheet 30 x 30 cm, 2 x 2 in, graphite, structured, R10/B



Mosaic sheet 30 x 30 cm, 2 x 2 in, shell, structured, R10/B



Mosaic sheet 30 x 30 cm, 2 x 2 in, sand, structured, R10/B



Mosaics glued thermoplastically on back of AGROB BUCHTAL can be used not only in dry zones but also without any problems in underwater areas (e.g. swimming pools/whirlpools) as well as in permanently wet areas (e.g. pool surrounds/showers).



Floor tile 60 x 60 cm, 24 x 24 in, structured, R10/A
 Floor tile 60 x 60 cm, 24 x 24 in, structured, R11/B



Cove skirting 10 x 50 cm, 4 x 20 in, structured



Cove skirting 10 x 60 cm, 4 x 24 in, structured



Skirting, cut, 6 x 50 cm, 2 3/8 x 20 in



Skirting, cut, 6 x 60 cm, 2 3/8 x 24 in



Stair tile with bevel and grooving, 31 x 145 cm, 12.4 x 58 in, structured, R10/A



Stair tile with bevel 31 x 145 cm, 12.4 x 58 in, structured, R10/A



Riser 28 x 145 cm, 12.2 x 58 in, structured



R11/B R11/C



pearl



mud



stone

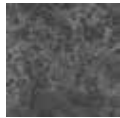

graphite



shell



sand



Floor tile 12.5 x 12.5 cm, 5 x 5 in, structured, R11/B



Floor tile 12.5 x 25 cm, 5 x 10 in, structured, R11/B



Floor tile 25 x 25 cm, 10 x 10 in, structured, R11/B



Floor tile 25 x 50 cm, 10 x 20 in, structured, R11/B



Wall tile 12.5 x 25 cm, 5 x 10 in, structured



Wall tile 25 x 50 cm, 10 x 20 in, structured

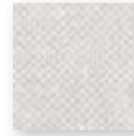

Grid profile tile 12.5 x 12.5 cm, 5 x 5 in, relief, R11/C

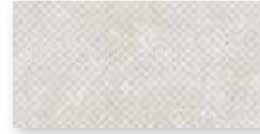

Grid profile tile 12.5 x 25 cm, 5 x 10 in, relief, R11/C



Grid profile tile 25 x 25 cm, 10 x 10 in, relief, R11/C



Grid profile tile 25 x 50 cm, 10 x 20 in, relief, R11/C

Grid Profile



Grooved tile 12.5 x 25 cm, 5 x 10 in, grooved, R11/C



Grooved tile 25 x 25 cm, 10 x 10 in, grooved, R11/C



Grooved tile 50 x 25 cm, 10 x 20 in, grooved, R11/C



Cove skirting 10 x 25 cm, 4 x 10 in, structured

Gutter tile
(trough depth 5 mm)



Gutter tile, 50 x 25 cm, 20 x 10 in, structured, R11/B



Gutter tile, mitred pair structured, R11/B



Gutter tile with outlet structured, R11/B



Terminal piece structured, R11/B

For details concerning gutter tiles, refer to page 114 and the following.



pearl



mud



stone

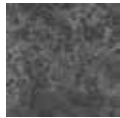

graphite



sand



Patio tile 50 x 100 cm, 20 x 40 in, structured, R11/B



Patio tile 60 x 90 cm, 24 x 36 in, structured, R11/B

Floor Tiles – joint 3 mm

Mosaic¹

Floor Tiles

5 x 5 cm



15 x 15 cm



25 x 50 cm²



25 x 50 cm^{2/3}



30 x 60 cm²



30 x 60 cm²



Sheet: 297 x 297 mm

Grid profile tile

	5 x 5 / 2 x 2	15 x 15 / 6 x 6	25 x 50 / 10 x 20	25 x 50 / 10 x 20	30 x 60 / 12 x 24	30 x 60 / 12 x 24	Nom. dim. - cm/in
	47 x 47 x 6.5 mm	147 x 147 x 8 mm	247 x 497 x 8 mm	247 x 497 x 8 mm	297 x 597 x 8 mm	297 x 597 x 8 mm	Work size
	structured, matt	structured, matt	structured, matt	relief, matt	structured, matt	structured, matt	Surface
	11 sheets	44.444	8.000	8.000	5.556	5.556	m ² - pieces
	12.331	17.555	17.040	17.040	17.413	17.413	m ² - kg
	11	35	9	9	6	6	Bundle - pieces
	1.000	0.788	1.125	1.125	1.080	1.080	Bundle - m ²
	12.331	13.825	19.170	19.170	18.804	18.804	Bundle - kg
	64.000	63.001	40.500	40.500	43.197	43.197	Pallet - m ²
	789.184	1,106.000	690.120	690.120	752.160	752.160	Pallet - kg
	Bla	Bla	Ala	Ala	Ala	Ala	Product standard
	R10/B	R10/B	R11/B	R11/C	R10/A	R11/B	Slip resistance
	1	2	2	2	2	2	Stress group
	430701H	430705H	430709H	<i>430713H</i>	430721H	430725H	
	Price gr. A226 (m ²)	Price gr. A154 (m ²)	Price gr. A166 (m ²)	Price gr. A187 (m ²)	Price gr. A124 (m ²)	Price gr. A142 (m ²)	pearl <input type="checkbox"/> V3
	430702H	430706H	430710H	<i>430714H</i>	430722H	430726H	mud <input type="checkbox"/> V3
	Price gr. A226 (m ²)	Price gr. A154 (m ²)	Price gr. A166 (m ²)	Price gr. A187 (m ²)	Price gr. A124 (m ²)	Price gr. A142 (m ²)	stone <input type="checkbox"/> V3
	430703H	430707H	430711H	<i>430715H</i>	430723H	430727H	
	Price gr. A226 (m ²)	Price gr. A154 (m ²)	Price gr. A166 (m ²)	Price gr. A187 (m ²)	Price gr. A124 (m ²)	Price gr. A142 (m ²)	graphite <input type="checkbox"/> V3
	430704H	430708H	430712H	<i>430716H</i>	430724H	430728H	
	Price gr. A226 (m ²)	Price gr. A154 (m ²)	Price gr. A166 (m ²)	Price gr. A187 (m ²)	Price gr. A124 (m ²)	Price gr. A142 (m ²)	shell <input type="checkbox"/> V3
	431501H	431503H	431505H	<i>431507H</i>	431509H	431511H	
	Price gr. A226 (m ²)	Price gr. A154 (m ²)	Price gr. A166 (m ²)	Price gr. A187 (m ²)	Price gr. A124 (m ²)	Price gr. A142 (m ²)	sand <input type="checkbox"/> V3
	431502H	431504H	431506H	<i>431508H</i>	431510H	431512H	
	Price gr. A226 (m ²)	Price gr. A154 (m ²)	Price gr. A166 (m ²)	Price gr. A187 (m ²)	Price gr. A124 (m ²)	Price gr. A142 (m ²)	



Floor Tiles – joint 3 mm

Floor Tiles¹

Stair Tile with bevel and grooves^{2/3/4}

Stair Tile with bevel^{2/3/4}

Riser^{2/3/4}

60 x 60 cm

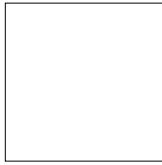

60 x 60 cm



31 x 145 cm



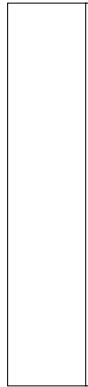

31 x 145 cm



28 x 145 cm



Nom. dim. - cm/in	60 x 60 / 24 x 24	60 x 60 / 24 x 24	31 x 145 / 12 3/8 x 58	31 x 145 / 12 3/8 x 58	28 x 145 / 11 3/16 x 58		
Work size	597 x 597 x 8 mm	597 x 597 x 8 mm	307 x 1447 x 10.5 mm	307 x 1447 x 10.5 mm	280 x 1447 x 10.5 mm		
Surface	structured, matt	structured, matt	structured, matt	structured, matt	structured, matt		
m ² /m - pieces	2.778/m ²	2.778/m ²	0.690/m	0.690/m	0.690/m		
m ² /m - kg	18.001/m ²	18.001/m ²	7.480/m	7.480/m	6.716/m		
Bundle - pieces	4	4	2	2	2		
Bundle - m ² /m	1.440 m ²	1.440 m ²	2.899 m	2.899 m	2.899 m		
Bundle - kg	25.920	25.920	21.682	21.682	19.466		
Pallet - m ²	43.197	43.197					
Pallet - kg	777.600	777.600					
Product standard	Ala	Ala	Ala	Ala	Ala		
Slip resistance	R10/A	R11/B	R10/A	R10/A			
Stress group	2	2	2	2	2		
pearl 	430729H Price gr. A136 (m ²)	430733H Price gr. A151 (m ²)	431576H-TF Price gr. AS77 (pce.)	431576H Price gr. AS60 (pce.)	431582H Price gr. AS28 (pce.)		
mud 	430730H Price gr. A136 (m ²)	430734H Price gr. A151 (m ²)	431577H-TF Price gr. AS77 (pce.)	431577H Price gr. AS60 (pce.)	431583H Price gr. AS28 (pce.)		
stone 	430731H Price gr. A136 (m ²)	430735H Price gr. A151 (m ²)	431578H-TF Price gr. AS77 (pce.)	431578H Price gr. AS60 (pce.)	431584H Price gr. AS28 (pce.)		
graphite 	430732H Price gr. A136 (m ²)	430736H Price gr. A151 (m ²)	431579H-TF Price gr. AS77 (pce.)	431579H Price gr. AS60 (pce.)	431585H Price gr. AS28 (pce.)		
shell 	431513H Price gr. A136 (m ²)	431515H Price gr. A151 (m ²)	431580H-TF Price gr. AS77 (pce.)	431580H Price gr. AS60 (pce.)	431586H Price gr. AS28 (pce.)		
sand 	431514H Price gr. A136 (m ²)	431516H Price gr. A151 (m ²)	431581H-TF Price gr. AS77 (pce.)	431581H Price gr. AS60 (pce.)	431587H Price gr. AS28 (pce.)		

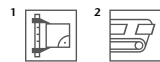

³ Only rectified on the two short sides. The long side can not be rectified.

⁴ For details, refer to page 296. For more solutions concerning stair design, refer to the series Area Pro in the 2024 programme of delivery.

Cove Skirting,
decorated^{1/2}

10 x 50 cm



10 x 60 cm



Skirting, cut¹

6 x 50 cm



6 x 60 cm



Letter Tile^{1/2/3}

25 x 50 cm

WT. 1.35m



	10 x 50 / 4 x 20	10 x 60 / 4 x 24	6 x 50 / 2 3/8 x 20	6 x 60 / 2 3/8 x 24	25 x 50 / 10 x 20	
	100 x 497/35 x 9 mm	100 x 597/35 x 9 mm	60 x 497 x 8 mm	60 x 597 x 8 mm	247 x 497 x 8 mm	Nom. dim. - cm/in
	structured, matt	structured, matt	structured, matt	structured, matt	structured, matt	Work size
	2.000	1.667	2.000	1.667	2.000	Surface
	2.000/m	2.000/m	1.098/m	1.100/m	2.130/pieces	m - pieces
	20	20	30	34		m/pce. - kg
	10.000	11.998	15.000	20.396		Bundle - pieces
	20,000	24.000	16.470	22.440		Bundle - m
						Bundle - kg
						Pallet - m ²
						Pallet - kg
	Alb	Alb	Ala	Ala	Ala	Product standard
					R11/B	Slip resistance
					2	Stress group
	430741H	430737H	430984H	430988H	430717H	pearl <input type="checkbox"/> V3
	Price gr. A441 (pce.)	Price gr. A445 (pce.)	Price gr. A434 (pce.)	Price gr. A434 (pce.)	Price gr. A668 (pce.)	
	430742H	430738H	430985H	430989H	430718H	mud <input type="checkbox"/> V3
	Price gr. A441 (pce.)	Price gr. A445 (pce.)	Price gr. A434 (pce.)	Price gr. A434 (pce.)	Price gr. A668 (pce.)	
	430743H	430739H	430986H	430990H	430719H	stone <input type="checkbox"/> V3
	Price gr. A441 (pce.)	Price gr. A445 (pce.)	Price gr. A434 (pce.)	Price gr. A434 (pce.)	Price gr. A668 (pce.)	
	430744H	430740H	430987H	430991H	430720H	graphite <input type="checkbox"/> V3
	Price gr. A441 (pce.)	Price gr. A445 (pce.)	Price gr. A434 (pce.)	Price gr. A434 (pce.)	Price gr. A668 (pce.)	
	431523H	431525H	431527H	431529H	431531H	shell <input type="checkbox"/> V3
	Price gr. A441 (pce.)	Price gr. A445 (pce.)	Price gr. A434 (pce.)	Price gr. A434 (pce.)	Price gr. A668 (pce.)	
	431524H	431526H	431528H	431530H	431532H	sand <input type="checkbox"/> V3
	Price gr. A441 (pce.)	Price gr. A445 (pce.)	Price gr. A434 (pce.)	Price gr. A434 (pce.)	Price gr. A668 (pce.)	



³ Only figures/letters in color 91 are available (neutral 10 / active white).



Wall and Floor Tiles – joint 6 mm

Wall Tile

Floor Tiles

12.5 x 25 cm



12.5 x 12.5 cm²



12.5 x 12.5 cm^{1/2}



12.5 x 25 cm



12.5 x 25 cm¹



25 x 25 cm



25 x 25 cm¹



	Grid profile tile			Grid profile tile			Grid profile tile
Nom. dim. - cm/in	12.5 x 25 / 5 x 10	12.5 x 12.5 / 5 x 5	12.5 x 12.5 / 5 x 5	12.5 x 25 / 5 x 10	12.5 x 25 / 5 x 10	25 x 25 / 10 x 10	25 x 25 / 10 x 10
Work size	119 x 244 x 8 mm	119 x 119 x 8 mm	119 x 119 x 8 mm	119 x 244 x 8 mm	119 x 244 x 8 mm	244 x 244 x 8 mm	244 x 244 x 8 mm
Surface	structured, matt	structured, matt	relief, matt	structured, matt	relief, matt	structured, matt	relief, matt
m ² - pieces	32.000	64.000	64.000	32.000	32.000	16.000	16.000
m ² - kg	15.680	15.360	15.360	15.680	15.680	16.960	16.960
Bundle - pieces	33	66	66	33	33	14	14
Bundle - m ²	1.031	1.031	1.031	1.031	1.031	0.875	0.875
Bundle - kg	16.170	15.840	15.840	16.170	16.170	14.840	14.840
Pallet - m ²	86.625	86.625	86.625	86.625	86.625	70.875	70.875
Pallet - kg	1,358.280	1,330.560	1,330.560	1,358.280	1,358.280	1,202.040	1,202.040
Product standard	Ala	Ala	Ala	Ala	Ala	Ala	Ala
Slip resistance	-	R11/B	R11/C	R11/B	R11/C	R11/B	R11/C
Stress group	2	2	2	2	2	2	2
pearl	430761H Price gr. A127 (m ²)	430753H Price gr. A166 (m ²)	430757H Price gr. A166 (m ²)	430763H Price gr. A136 (m ²)	430767H Price gr. A148 (m ²)	430771H Price gr. A175 (m ²)	430775H Price gr. A142 (m ²)
mud		430754H Price gr. A166 (m ²)	430758H Price gr. A166 (m ²)	430764H Price gr. A136 (m ²)	430768H Price gr. A148 (m ²)	430772H Price gr. A175 (m ²)	430776H Price gr. A142 (m ²)
stone		430755H Price gr. A166 (m ²)	430759H Price gr. A166 (m ²)	430765H Price gr. A136 (m ²)	430769H Price gr. A148 (m ²)	430773H Price gr. A175 (m ²)	430777H Price gr. A142 (m ²)
graphite	430762H Price gr. A127 (m ²)	430756H Price gr. A166 (m ²)	430760H Price gr. A166 (m ²)	430766H Price gr. A136 (m ²)	430770H Price gr. A148 (m ²)	430774H Price gr. A175 (m ²)	430778H Price gr. A142 (m ²)
shell	431533H Price gr. A127 (m ²)	431534H Price gr. A166 (m ²)	431536H Price gr. A166 (m ²)	431538H Price gr. A136 (m ²)	431540H Price gr. A148 (m ²)	431542H Price gr. A175 (m ²)	431544H Price gr. A142 (m ²)
sand		431535H Price gr. A166 (m ²)	431537H Price gr. A166 (m ²)	431539H Price gr. A136 (m ²)	431541H Price gr. A148 (m ²)	431543H Price gr. A175 (m ²)	431545H Price gr. A142 (m ²)



² Supplied as double-tiles; to be broken by customer.

Wall Tile²

Floor Tiles²

Grooved Tiles 12.5 mm thick,
for continuing the pool edge system
„Finland II“^{1/3/4}

25 x 50 cm



25 x 50 cm



25 x 50 cm¹



50 x 25 cm

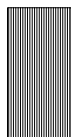

25 x 25 cm



12,5 x 25 cm



Grid profile tile

25 x 50 / 10 x 20	25 x 50 / 10 x 20	25 x 50 / 10 x 20	50 x 25 / 20 x 10	25 x 25 / 10 x 10	12.5 x 25 / 5 x 10	Nom. dim. - cm/in
244 x 494 x 8 mm	244 x 494 x 8 mm	244 x 494 x 8 mm	494 x 244 x 12,5 mm	244 x 244 x 12,5 mm	119 x 244 x 12,5 mm	Work size - mm
structured, matt	structured, matt	relief, matt	grooved, matt	grooved, matt	grooved, matt	Surface
8.000/m ²	8.000/m ²	8.000/m ²	2.000/m	4.000/m	8.000/m	m ² /m - pieces
17.040/m ²	17.040/m ²	17.040/m ²	3.550/pieces	1.775/pieces	0.888/pieces	m ² /pce. - kg
9	9	9	6	9	21	Bundle - pieces
1.125/m ²	1.125/m ²	1.125/m ²	3.000/m	2.250/m	2.625/m	Bundle - m ² / m
19.170	19.170	19.170	21.300	15.975	18.648	Bundle - kg
40.500	40.500	40.500				Pallet - m ²
690.120	690.120	690.120				Pallet - kg
Ala	Ala	Ala	Ala	Ala	Ala	Product standard
-	R11/B	R11/C	R11/C	R11/C	R11/C	Slip resistance
	2	2				Stress group
430779H	430781H	430785H	430789H	430793H	430802H	pearl <input type="checkbox"/>
Price gr. A154 (m ²)	Price gr. A166 (m ²)	Price gr. A187 (m ²)	Price gr. A560 (pce.)	Price gr. A480 (pce.)	Price gr. A430 (pce.)	
	430782H	430786H	430790H	430794H	430803H	mud <input type="checkbox"/>
	Price gr. A166 (m ²)	Price gr. A187 (m ²)	Price gr. A560 (pce.)	Price gr. A480 (pce.)	Price gr. A430 (pce.)	
	430783H	430787H	430791H	430795H	430804H	stone <input type="checkbox"/>
	Price gr. A166 (m ²)	Price gr. A187 (m ²)	Price gr. A560 (pce.)	Price gr. A480 (pce.)	Price gr. A430 (pce.)	
430780H	430784H	430788H	430792H	430796H	430805H	graphite <input type="checkbox"/>
Price gr. A154 (m ²)	Price gr. A166 (m ²)	Price gr. A187 (m ²)	Price gr. A560 (pce.)	Price gr. A480 (pce.)	Price gr. A430 (pce.)	
431546H	431547H	431549H	431551H	431553H	431555H	shell <input type="checkbox"/>
Price gr. A154 (m ²)	Price gr. A166 (m ²)	Price gr. A187 (m ²)	Price gr. A560 (pce.)	Price gr. A480 (pce.)	Price gr. A430 (pce.)	
	431548H	431550H	431552H	431554H	431556H	sand <input type="checkbox"/>
	Price gr. A166 (m ²)	Price gr. A187 (m ²)	Price gr. A560 (pce.)	Price gr. A480 (pce.)	Price gr. A430 (pce.)	



³ Short edge rectified

⁴ For more details concerning the pool edge system Finland II, page 30 and the following.



Cove Skirting, decorated^{1/2}

10 x 25 cm



Gutter Tiles^{2/3/4/6}

50 x 25 cm



50 x 25 cm⁵

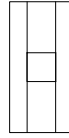

50 x 25 cm

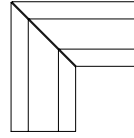

50 x 25 cm⁵

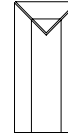

	10 x 25 / 4 x 10	50 x 25 / 20 x 10	50 x 25 / 20 x 10	50 x 25 / 20 x 10	Gutter tile with outlet 110 / 110 mm	Gutter tile, mitred pair	Gutter tile, terminal piece
Nom. dim. - cm/in	100 x 244/35 x 9 mm	494 x 244 x 14 mm	494 x 244 x 14 mm	494 x 244 x 14 mm	(2x) 490 x 244 x 14 mm	494 x 244 x 14 mm	
Work size - mm	structured, matt	structured, matt	structured, matt	structured, matt	structured, matt	structured, matt	structured, matt
Surface	4.000	2.000	2.000	2.000	3.800/pair	2.500/pieces	
m - pieces	0.500/pieces	2.500/pieces	2.300/pieces	2.300/pieces	2 pair	5 pieces	
pce./pair - kg	20 pieces	5 pieces	5 pieces	5 pieces			
Bundle - pce./pair	2.500	12.500	11.500	11.500	7.600	12.500	
Bundle - m							
Bundle - kg							
Pallet - m ²							
Pallet - kg							
Product standard	Alb	Ala	Ala	Ala	Ala	Ala	
Slip resistance		R11/B	R11/B	R11/B	R11/B	R11/B	
	430806H	430810H	430814H	430818H	430822H		
pearl <input type="checkbox"/> V3	Price gr. A423 (pce.)	Price gr. A519 (pce.)	Price gr. A593 (pce.)	Price gr. A645 (pair)	Price gr. A593 (pce.)		
	430807H	430811H	430815H	430819H	430823H		
mud <input type="checkbox"/> V3	Price gr. A423 (pce.)	Price gr. A519 (pce.)	Price gr. A593 (pce.)	Price gr. A645 (pair)	Price gr. A593 (pce.)		
	430808H	430812H	430816H	430820H	430824H		
stone <input type="checkbox"/> V3	Price gr. A423 (pce.)	Price gr. A519 (pce.)	Price gr. A593 (pce.)	Price gr. A645 (pair)	Price gr. A593 (pce.)		
	430809H	430813H	430817H	430821H	430825H		
graphite <input type="checkbox"/> V3	Price gr. A423 (pce.)	Price gr. A519 (pce.)	Price gr. A593 (pce.)	Price gr. A645 (pair)	Price gr. A593 (pce.)		
	431557H	431559H	431561H	431563H	431565H		
shell <input type="checkbox"/> V3	Price gr. A423 (pce.)	Price gr. A519 (pce.)	Price gr. A593 (pce.)	Price gr. A645 (pair)	Price gr. A593 (pce.)		
	431558H	431560H	431562H	431564H	431566H		
sand <input type="checkbox"/> V3	Price gr. A423 (pce.)	Price gr. A519 (pce.)	Price gr. A593 (pce.)	Price gr. A645 (pair)	Price gr. A593 (pce.)		



³ Also available in a length of 497 mm on request
⁴ Short edges rectified
⁵ Minimum order quantity: 10 pieces. In case of smaller quantities, the price must be individually calculated.
⁶ For further details concerning gutter tiles, refer to page 114 and the following.

Patio Tiles –
3 mm joint^{1/2}

50 x 100 cm

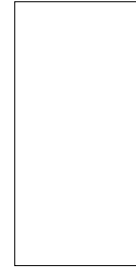

60 x 90 cm

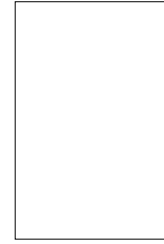

					50 x 100 / 20 x 40	60 x 90 / 24 x 36		
					497 x 997 x 20 mm	597 x 897 x 20 mm		Nom. dim. - cm/in
					structured, matt	structured, matt		Work size - mm
					2.000	1.852		Surface
					43.060	43.152		m ² - pieces
					1	1		m ² - kg
					0.500	0.540		Bundle - pieces
					21.530	23.300		Bundle - m ²
					22.500	11.339		Bundle - kg
					968.850	489.300		Pallet - m ²
					Alla	Alla		Pallet - kg
					R11/B	R11/B		Product standard
					3	3		Slip resistance
					430826H	430830H	4	Stress group
					Price gr. A277 (m ²)	Price gr. A262 (m ²)		pearl <input type="checkbox"/> V3
					430827H	430831H	4	mud <input type="checkbox"/> V3
					Price gr. A277 (m ²)	Price gr. A262 (m ²)		
					430828H	430832H	4	stone <input type="checkbox"/> V3
					Price gr. A277 (m ²)	Price gr. A262 (m ²)		
					430829H	430833H	4	graphite <input type="checkbox"/> V3
					Price gr. A277 (m ²)	Price gr. A262 (m ²)		
					431567H	431568H	4	sand <input type="checkbox"/> V3
					Price gr. A277 (m ²)	Price gr. A262 (m ²)		



² High weight only to carry with two persons.



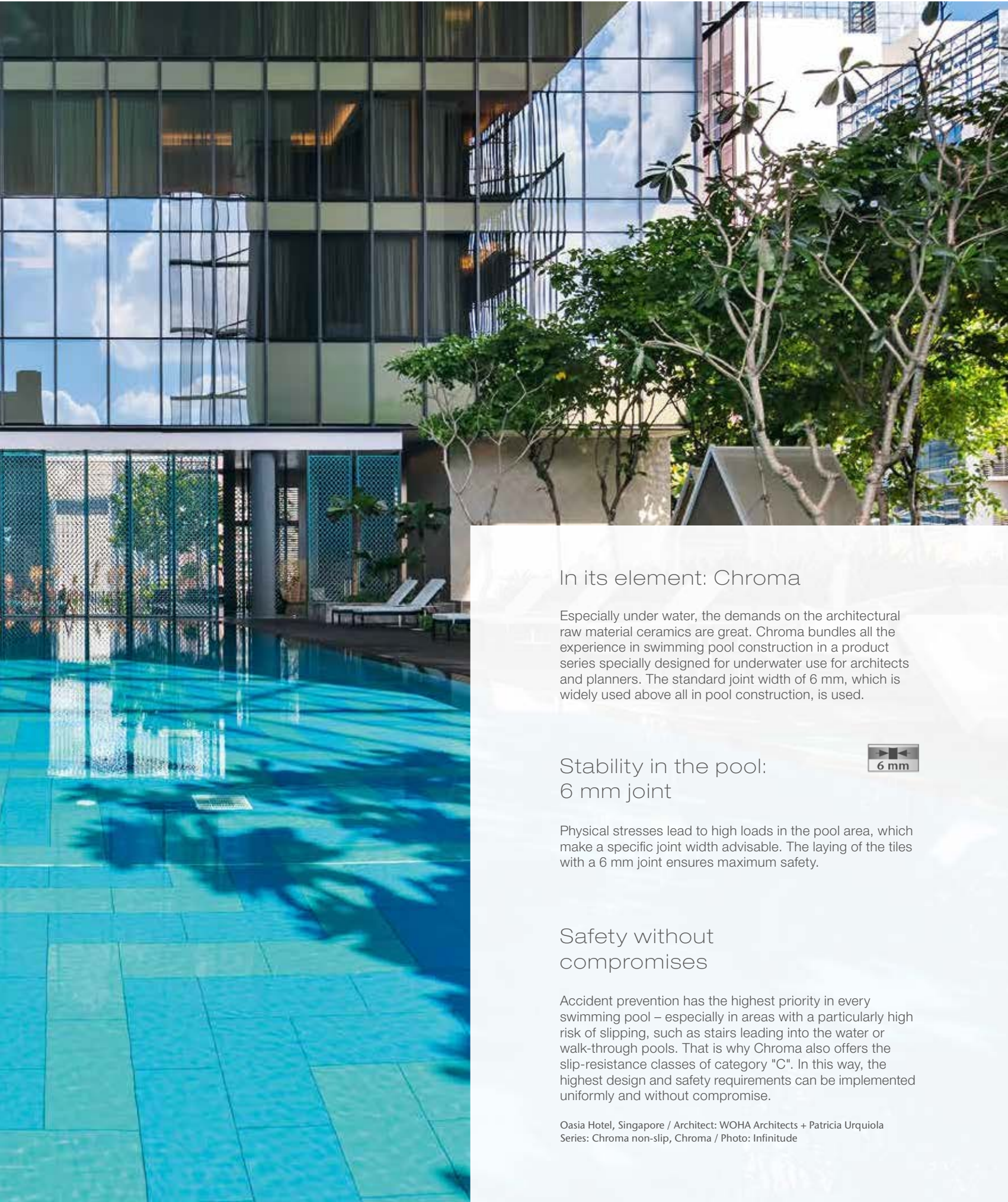

In its element: Chroma

Especially under water, the demands on the architectural raw material ceramics are great. Chroma bundles all the experience in swimming pool construction in a product series specially designed for underwater use for architects and planners. The standard joint width of 6 mm, which is widely used above all in pool construction, is used.

Stability in the pool: 6 mm joint



Physical stresses lead to high loads in the pool area, which make a specific joint width advisable. The laying of the tiles with a 6 mm joint ensures maximum safety.

Safety without compromises

Accident prevention has the highest priority in every swimming pool – especially in areas with a particularly high risk of slipping, such as stairs leading into the water or walk-through pools. That is why Chroma also offers the slip-resistance classes of category "C". In this way, the highest design and safety requirements can be implemented uniformly and without compromise.

Oasia Hotel, Singapore / Architect: WOHA Architects + Patricia Urquiola
Series: Chroma non-slip, Chroma / Photo: Infinitude

COLOR SYSTEM UNICOLOR – A color sphere becomes a sphere of possibilities

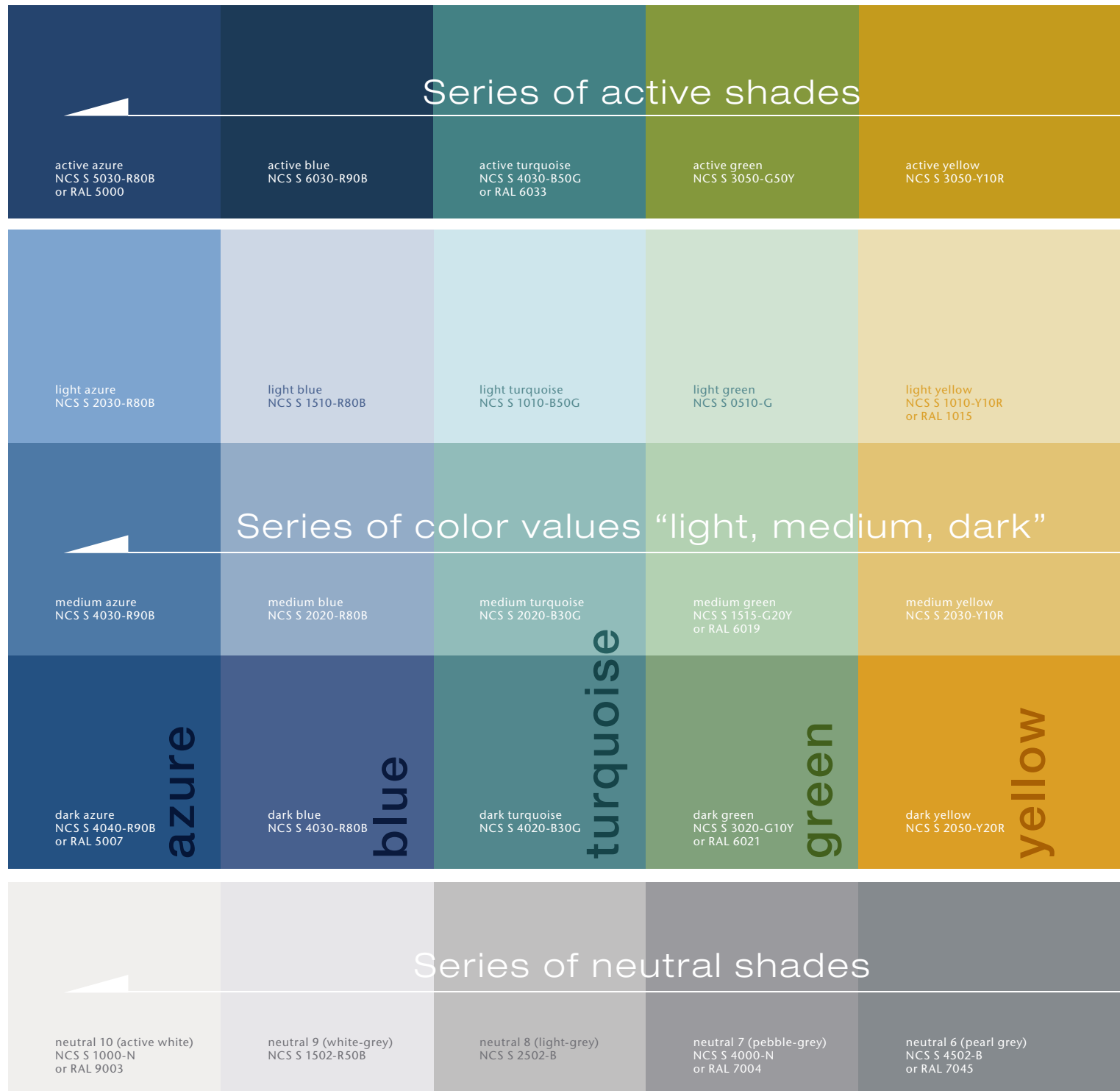

Contrasting colors (glossy)

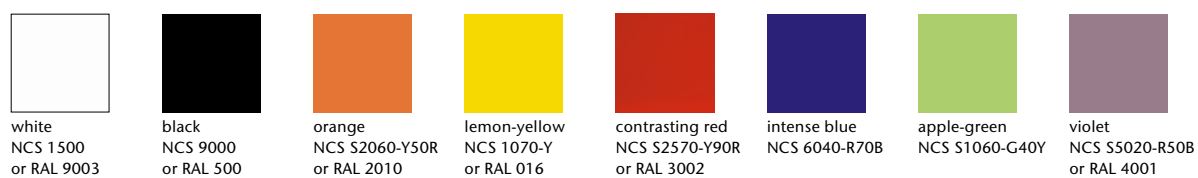

active ochre NCS S 3050-Y40R	active salmon NCS S 4040-Y70R	active oxid red NCS S 4050-Y90R	active stone grey NCS S 5030-Y90R	active sand grey NCS S 7010-Y90R
light ochre NCS S 2030-Y20R	light salmon NCS S 1515-Y50R	light oxid red NCS S 2010-Y80R	light stone grey NCS S 2502-R	light sand grey NCS S 1502-Y
medium ochre NCS S 3030-Y30R	medium salmon NCS S 2020-Y50R	medium oxid red NCS S 3020-Y80R	medium stone grey NCS S 3502-R or RAL 7036	medium sand grey NCS S 3005-Y50R
dark ochre NCS S 4030-Y50R	dark salmon NCS S 3040-Y60R	dark oxid red NCS S 5020-Y80R	dark stone grey NCS S 6005-Y80R	dark sand grey NCS S 6010-Y50R
ochre	salmon	oxid red	stone grey	sand grey
neutral 5 (basalt-grey) NCS S 5502-B or RAL 7046	neutral 4 (graphite-black) NCS S 6000-N or RAL 7037	neutral 3 (asphalt black) NCS S 6500-N	neutral 2 (anthracite) NCS S 7500-N or RAL 7015	neutral 1 (deep black) NCS S 9000-N or RAL 9017

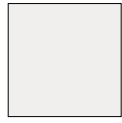

701
neutral 10 (active white)

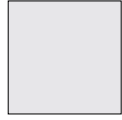

552119
neutral 9 (white-grey)



552118
neutral 8 (light-grey)



552117
neutral 7 (pebble-grey)



552116
neutral 6 (pearl grey)



552115
neutral 5 (basalt-grey)



552114
neutral 4 (graphite-black)



552113
neutral 3 (asphalt black)



552112
neutral 2 (anthracite)



5716
neutral 1 (deep black)



552004
dark azure



552008
dark blue



552012
dark turquoise



552016
dark green



552020
dark yellow



552024
dark ochre



552028
dark salmon



552032
dark oxid red



552036
dark stone grey



552040
dark sand grey



552003
medium azure



552007
medium blue



552011
medium turquoise



552015
medium green



552019
medium yellow



552023
medium ochre



552027
medium salmon



552031
medium oxid red



552035
medium stone grey



552039
medium sand grey



552002
light azure

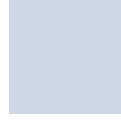

552006
light blue



552010
light turquoise



552014
light green



552018
light yellow



552022
light ochre



552026
light salmon



552030
light oxid red



552034
light stone grey



552038
light sand grey



552001
active azure



552005
active blue



552009
active turquoise



552013
active green



552017
active yellow



552021
active ochre



552025
active salmon



552029
active oxide red



552033
active stone grey



552037
active sand grey

Contrasting colors
(glossy)



700
white



717
black



151
orange



150
lemon-yellow



154
contrasting red



144
intense blue



152
apple-green



153
violet



*Floor/Wall tile
6,2 x 25 cm, smooth*

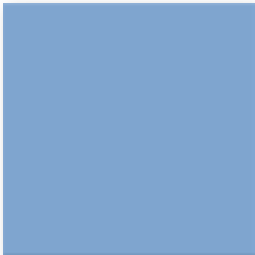

*Floor/Wall tile
25 x 25 cm, smooth*



*Floor/Wall tile
12,5 x 12,5 cm, smooth*



*Floor/Wall tile
12,5 x 25 cm, smooth*

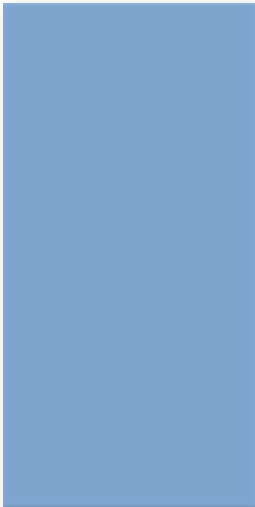

*Floor/Wall tile
25 x 50 cm, smooth*



*Floor/Wall tile
12,5 x 50 cm, smooth*

Floor/Wall Tiles

6.2 x 25 cm^{3/6}



12.5 x 12.5 cm^{3/6}



12.5 x 25 cm³



12.5 x 50 cm¹

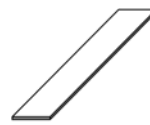

25 x 25 cm³



25 x 50 cm¹

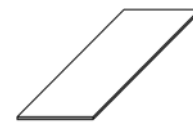

Model number	18210H	12020H	18120H	41550HK	12050H	42550HK
Nom. dim. - cm/in	6.2 x 25 / 2 1/2 x 10	12.5 x 12.5 / 5 x 5	12.5 x 25 / 5 x 10	12.5 x 50 / 5 x 20	25 x 25 / 10 x 10	25 x 50 / 10 x 20
Work size	56 x 244 x 6 mm	119 x 119 x 6 mm	119 x 244 x 6 mm	119 x 494 x 8 mm	244 x 244 x 6 mm	244 x 494 x 8 mm
Surface	smooth, silky-matt ⁵	smooth, silky-matt ⁵	smooth, silky-matt ⁵	smooth, silky-matt ⁵	smooth, silky-matt ⁵	smooth, silky-matt ⁵
m ² - pieces	64.000	64.000	32.000	16.000	16.000	8.000
m ² - kg	10.880	12.160	12.160	17.040	12.800	17.040
Bundle - pieces	88	88	44	8	18	9
Bundle - m ²	1.375	1.375	1.375	0.500	1.125	1.125
Bundle - kg	14.960	16.720	16.720	8.520	14.400	19.170
Pallet - m ²	132.000	115.500	115.500	55.000	91.125	40.500
Pallet - kg	1,436.160	1,404.480	1,404.480	937.200	1,166.400	690.120
Product standard	Alb	Alb	Alb	Alb	Alb	Alb
neutral 10 (active white glossy)	4 700i-18210H Price gr. A157 (m ²)	700i-12020H Price gr. A157 (m ²)	700i-18120H Price gr. A94 (m ²)	700i-41550HK Price gr. A178 (m ²)	700i-12050H Price gr. A157 (m ²)	700i-42550HK Price gr. A157 (m ²)
neutral 10 (active white matt)	4 701i-18210H Price gr. A157 (m ²)	701i-12020H Price gr. A157 (m ²)	701i-18120H Price gr. A94 (m ²)	701i-41550HK Price gr. A178 (m ²)	701i-12050H Price gr. A157 (m ²)	701i-42550HK Price gr. A157 (m ²)
neutral 9 (white grey)	4 552119-18210H² Price gr. A217 (m ²)	552119-12020H² Price gr. A217 (m ²)	552119-18120H Price gr. A121 (m ²)	552119-41550HK² Price gr. A235 (m ²)	552119-12050H² Price gr. A217 (m ²)	552119-42550HK² Price gr. A217 (m ²)
neutral 8 (light-grey)	4 552118-18210H Price gr. A187 (m ²)	552118-12020H² Price gr. A217 (m ²)	552118-18120H Price gr. A121 (m ²)	552118-41550HK² Price gr. A235 (m ²)	552118-12050H² Price gr. A217 (m ²)	552118-42550HK² Price gr. A217 (m ²)
neutral 7 (pebble grey)	4 552117-18210H Price gr. A187 (m ²)	552117-12020H² Price gr. A217 (m ²)	552117-18120H Price gr. A121 (m ²)	552117-41550HK² Price gr. A235 (m ²)	552117-12050H Price gr. A187 (m ²)	552117-42550HK² Price gr. A217 (m ²)
neutral 6 (pearl grey)	3 552116-18210H² Price gr. A217 (m ²)	552116-12020H² Price gr. A217 (m ²)	552116-18120H Price gr. A121 (m ²)	552116-41550HK² Price gr. A235 (m ²)	552116-12050H² Price gr. A217 (m ²)	552116-42550HK² Price gr. A217 (m ²)
neutral 5 (basalt grey)	3 552115-18210H² Price gr. A217 (m ²)	552115-12020H² Price gr. A217 (m ²)	552115-18120H² Price gr. A151 (m ²)	552115-41550HK² Price gr. A235 (m ²)	552115-12050H² Price gr. A217 (m ²)	552115-42550HK² Price gr. A217 (m ²)
neutral 4 (graphite black)	3 552114-18210H^{2/4} Price gr. A217 (m ²)	552114-12020H^{2/4} Price gr. A217 (m ²)	552114-18120H^{2/4} Price gr. A151 (m ²)	552114-41550HK^{2/4} Price gr. A235 (m ²)	552114-12050H^{2/4} Price gr. A217 (m ²)	552114-42550HK⁴ Price gr. A187 (m ²)
neutral 3 (asphalt black)	3 552113-18210H² Price gr. A217 (m ²)	552113-12020H² Price gr. A217 (m ²)	552113-18120H Price gr. A121 (m ²)	552113-41550HK² Price gr. A235 (m ²)	552113-12050H² Price gr. A217 (m ²)	552113-42550HK² Price gr. A217 (m ²)
neutral 2 (anthracite)	2 552112-18210H Price gr. A187 (m ²)	552112-12020H² Price gr. A187 (m ²)	552112-18120H Price gr. A121 (m ²)	552112-41550HK² Price gr. A235 (m ²)	552112-12050H Price gr. A187 (m ²)	552112-42550HK Price gr. A187 (m ²)
neutral 1 (deep black)	1 5716i-18210H⁴ Price gr. A187 (m ²)	5716i-12020H⁴ Price gr. A187 (m ²)	5716i-18120H⁴ Price gr. A121 (m ²)	5716-41550HK⁴ Price gr. A208 (m ²)	5716i-12050H⁴ Price gr. A187 (m ²)	5716i-42550HK⁴ Price gr. A187 (m ²)
active azure	2 552001-18210H Price gr. A187 (m ²)	552001-12020H Price gr. A208 (m ²)	552001-18120H Price gr. A121 (m ²)	552001-41550HK Price gr. A208 (m ²)	552001-12050H Price gr. A187 (m ²)	552001-42550HK Price gr. A187 (m ²)
light azure	4 552002-18210H Price gr. A187 (m ²)	552002-12020H Price gr. A187 (m ²)	552002-18120H Price gr. A121 (m ²)	552002-41550HK Price gr. A208 (m ²)	552002-12050H Price gr. A187 (m ²)	552002-42550HK Price gr. A187 (m ²)
medium azure	3 552003-18210H Price gr. A187 (m ²)	552003-12020H Price gr. A187 (m ²)	552003-18120H Price gr. A121 (m ²)	552003-41550HK² Price gr. A235 (m ²)	552003-12050H Price gr. A187 (m ²)	552003-42550HK Price gr. A187 (m ²)
dark azure	2 552004-18210H Price gr. A187 (m ²)	552004-12020H Price gr. A187 (m ²)	552004-18120H Price gr. A121 (m ²)	552004-41550HK² Price gr. A235 (m ²)	552004-12050H² Price gr. A217 (m ²)	552004-42550HK² Price gr. A217 (m ²)
active blue	2 552005-18210H² Price gr. A217 (m ²)	552005-12020H Price gr. A187 (m ²)	552005-18120H Price gr. A121 (m ²)	552005-41550HK² Price gr. A235 (m ²)	552005-12050H Price gr. A187 (m ²)	552005-42550HK² Price gr. A217 (m ²)
light blue	4 552006-18210H² Price gr. A217 (m ²)	552006-12020H Price gr. A187 (m ²)	552006-18120H Price gr. A121 (m ²)	552006-41550HK² Price gr. A235 (m ²)	552006-12050H Price gr. A187 (m ²)	552006-42550HK Price gr. A187 (m ²)
medium blue	3 552007-18210H Price gr. A187 (m ²)	552007-12020H Price gr. A187 (m ²)	552007-18120H Price gr. A121 (m ²)	552007-41550HK² Price gr. A235 (m ²)	552007-12050H Price gr. A187 (m ²)	552007-42550HK Price gr. A187 (m ²)
dark blue	2 552008-18210H Price gr. A187 (m ²)	552008-12020H² Price gr. A217 (m ²)	552008-18120H Price gr. A121 (m ²)	552008-41550HK² Price gr. A235 (m ²)	552008-12050H² Price gr. A217 (m ²)	552008-42550HK² Price gr. A217 (m ²)
active turquoise	2 552009-18210H Price gr. A187 (m ²)	552009-12020H² Price gr. A217 (m ²)	552009-18120H Price gr. A121 (m ²)	552009-41550HK² Price gr. A235 (m ²)	552009-12050H² Price gr. A217 (m ²)	552009-42550HK² Price gr. A217 (m ²)
light turquoise	4 552010-18210H Price gr. A187 (m ²)	552010-12020H Price gr. A187 (m ²)	552010-18120H Price gr. A121 (m ²)	552010-41550HK² Price gr. A235 (m ²)	552010-12050H² Price gr. A217 (m ²)	552010-42550HK² Price gr. A217 (m ²)
medium turquoise	3 552011-18210H Price gr. A187 (m ²)	552011-12020H Price gr. A187 (m ²)	552011-18120H Price gr. A121 (m ²)	552011-41550HK² Price gr. A235 (m ²)	552011-12050H Price gr. A187 (m ²)	552011-42550HK² Price gr. A217 (m ²)
dark turquoise	2 552012-18210H⁴ Price gr. A187 (m ²)	552012-12020H⁴ Price gr. A187 (m ²)	552012-18120H⁴ Price gr. A121 (m ²)	552012-41550HK^{2/4} Price gr. A235 (m ²)	552012-12050H^{2/4} Price gr. A217 (m ²)	552012-42550HK^{2/4} Price gr. A217 (m ²)



³ Overglazed edges / corners, refer to page 149

⁴ Color deviations from the standard due to production reasons are possible.

⁵ Exception neutral 10 (active white glossy): smooth, glossy

⁶ Supplied as double-tiles; to be broken by customer.

Overglazed Edges/Corners^{1/2}
Floor/Wall Tiles

6.2 x 25 cm



overglazed
corner left

6.2 x 25 cm



overglazed
corner right

12.5 x 12.5 cm



overglazed
corner left

12.5 x 25 cm



overglazed
corner left

12.5 x 25 cm



overglazed
corner right

25 x 25 cm

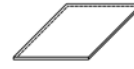

overglazed
corner left



Model number	Nom. dim. - cm/in	Work size	Surface	m ² - pieces	m ² - kg	Bundle - pieces	Bundle - m ²	Bundle - kg	Pallet - m ²	Pallet - kg	Product standard			
18213H	6.2 x 25 / 2 1/2 x 10	56 x 244 x 6 mm	smooth, silky-matt ⁴	64.000	10.880	88	1.375	14.960	132.000	1,436.160	Alb			
18214H	6.2 x 25 / 2 1/2 x 10	56 x 244 x 6 mm	smooth, silky-matt ⁴	64.000	10.880	88	1.375	14.960	132.000	1,436.160	Alb			
12023H	12.5 x 12.5 / 5 x 5	119 x 119 x 6 mm	smooth, silky-matt ⁴	64.000	12.160	88	1.375	16.720	115.500	1,404.480	Alb			
18123H	12.5 x 25 / 5 x 10	119 x 244 x 6 mm	smooth, silky-matt ⁴	32.000	12.160	44	1.375	16.720	115.500	1,404.480	Alb			
18124H	12.5 x 25 / 5 x 10	119 x 244 x 6 mm	smooth, silky-matt ⁴	32.000	12.160	44	1.375	16.720	115.500	1,404.480	Alb			
12053H	25 x 25 / 10 x 10	244 x 244 x 6 mm	smooth, silky-matt ⁴	16.000	12.800	18	1.125	14.400	91.125	1,166.400	Alb			
												4		
700i-18213H	Price gr. A157 (m ²)											neutral 10 (active white glossy)	VO	
701i-18213H	Price gr. A157 (m ²)											neutral 10 (active white matt)	VO	
5716i-18213H ³	Price gr. A187 (m ²)											1	neutral 1 (deep black)	VO
552001-18213H	Price gr. A187 (m ²)											2	active azure	VO
552002-18213H	Price gr. A187 (m ²)											4	light azure	VO
5716i-18214H ³	Price gr. A187 (m ²)													
552001-18214H	Price gr. A187 (pce.)													
552002-18214H	Price gr. A187 (m ²)													
5716i-12023H ³	Price gr. A187 (m ²)													
552001-12023H	Price gr. A187 (m ²)													
552002-12023H	Price gr. A187 (m ²)													
5716i-18123H ³	Price gr. A136 (m ²)													
552001-18123H	Price gr. A136 (m ²)													
552002-18123H	Price gr. A136 (m ²)													
5716i-18124H ³	Price gr. A136 (m ²)													
552001-18124H	Price gr. A136 (m ²)													
552002-18124H	Price gr. A136 (m ²)													
5716i-12053H ³	Price gr. A187 (m ²)													
552001-12053H	Price gr. A187 (m ²)													
552002-12053H	Price gr. A187 (m ²)													



³ Production-related color deviations from the standard are possible.
⁴ Exception neutral 10 (active white glossy): smooth, glossy



Overglazed edges available on request:				
Replace last figure 0 of Standard model no. by 3 = corner left	... 4 = corner right	overglazed edges	Example: Standard model no. 18120 = 119 x 244 x 6 mm, model no. 18123 = overglazed corner left

Floor/Wall Tiles

6.2 x 25 cm^{3/5}



12.5 x 12.5 cm^{3/5}



12.5 x 25 cm³



12.5 x 50 cm¹

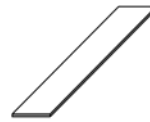

25 x 25 cm³



25 x 50 cm¹

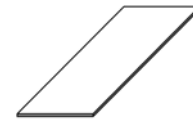

Model number	18210H	12020H	18120H	41550HK	12050H	42550HK
Nom. dim. - cm/in	6.2 x 25 / 2 1/2 x 10	12.5 x 12.5 / 5 x 5	12.5 x 25 / 5 x 10	12.5 x 50 / 5 x 20	25 x 25 / 10 x 10	25 x 50 / 10 x 20
Work size	56 x 244 x 6 mm	119 x 119 x 6 mm	119 x 244 x 6 mm	119 x 494 x 8 mm	244 x 244 x 6 mm	244 x 494 x 8 mm
Surface	smooth, silky-matt	smooth, silky-matt	smooth, silky-matt	smooth, silky-matt	smooth, silky-matt	smooth, silky-matt
m ² - pieces	64.000	64.000	32.000	16.000	16.000	8.000
m ² - kg	10.880	12.160	12.160	17.040	12.800	17.040
Bundle - pieces	88	88	44	8	18	9
Bundle - m ²	1.375	1.375	1.375	0.500	1.125	1.125
Bundle - kg	14.960	16.720	16.720	8.520	14.400	19.170
Pallet - m ²	132.000	115.500	115.500	55.000	91.125	40.500
Pallet - kg	1,436.160	1,404.480	1,404.480	937.200	1,166.400	690.120
Product standard	Alb	Alb	Alb	Alb	Alb	Alb
Stress group	2	2	2	2	2	2
active green	552013-18210H Price gr. A187 (m ²)	552013-12020H Price gr. A187 (m ²)	552013-18120H Price gr. A121 (m ²)	552013-41550HK² Price gr. A235 (m ²)	552013-12050H² Price gr. A217 (m ²)	552013-42550HK² Price gr. A217 (m ²)
light green	552014-18210H Price gr. A187 (m ²)	552014-12020H Price gr. A187 (m ²)	552014-18120H Price gr. A121 (m ²)	552014-41550HK² Price gr. A235 (m ²)	552014-12050H Price gr. A187 (m ²)	552014-42550HK² Price gr. A217 (m ²)
medium green	552015-18210H Price gr. A187 (m ²)	552015-12020H Price gr. A187 (m ²)	552015-18120H Price gr. A121 (m ²)	552015-41550HK² Price gr. A235 (m ²)	552015-12050H Price gr. A187 (m ²)	552015-42550HK Price gr. A187 (m ²)
dark green	552016-18210H Price gr. A187 (m ²)	552016-12020H Price gr. A187 (m ²)	552016-18120H Price gr. A121 (m ²)	552016-41550HK² Price gr. A235 (m ²)	552016-12050H Price gr. A187 (m ²)	552016-42550HK² Price gr. A217 (m ²)
active yellow	552017-18210H^{2/4} Price gr. A217 (m ²)	552017-12020H^{2/4} Price gr. A217 (m ²)	552017-18120H⁴ Price gr. A121 (m ²)	552017-41550HK^{2/4} Price gr. A235 (m ²)	552017-12050H^{2/4} Price gr. A217 (m ²)	552017-42550HK^{2/4} Price gr. A217 (m ²)
light yellow	552018-18210H² Price gr. A217 (m ²)	552018-12020H Price gr. A187 (m ²)	552018-18120H Price gr. A121 (m ²)	552018-41550HK² Price gr. A235 (m ²)	552018-12050H Price gr. A187 (m ²)	552018-42550HK Price gr. A187 (m ²)
medium yellow	552019-18210H Price gr. A187 (m ²)	552019-12020H Price gr. A187 (m ²)	552019-18120H Price gr. A121 (m ²)	552019-41550HK² Price gr. A235 (m ²)	552019-12050H Price gr. A187 (m ²)	552019-42550HK² Price gr. A217 (m ²)
dark yellow	552020-18210H⁴ Price gr. A187 (m ²)	552020-12020H^{2/4} Price gr. A217 (m ²)	552020-18120H⁴ Price gr. A121 (m ²)	552020-41550HK^{2/4} Price gr. A235 (m ²)	552020-12050H^{2/4} Price gr. A217 (m ²)	552020-42550HK^{2/4} Price gr. A217 (m ²)
active ochre	552021-18210H^{2/4} Price gr. A217 (m ²)	552021-12020H^{2/4} Price gr. A217 (m ²)	552021-18120H^{2/4} Price gr. A151 (m ²)	552021-41550HK^{2/4} Price gr. A235 (m ²)	552021-12050H^{2/4} Price gr. A217 (m ²)	552021-42550HK^{2/4} Price gr. A217 (m ²)
light ochre	552022-18210H Price gr. A187 (m ²)	552022-12020H² Price gr. A217 (m ²)	552022-18120H² Price gr. A151 (m ²)	552022-41550HK² Price gr. A235 (m ²)	552022-12050H² Price gr. A217 (m ²)	552022-42550HK² Price gr. A217 (m ²)
medium ochre	552023-18210H² Price gr. A217 (m ²)	552023-12020H² Price gr. A217 (m ²)	552023-18120H Price gr. A121 (m ²)	552023-41550HK² Price gr. A235 (m ²)	552023-12050H² Price gr. A217 (m ²)	552023-42550HK² Price gr. A217 (m ²)
dark ochre	552024-18210H² Price gr. A217 (m ²)	552024-12020H² Price gr. A217 (m ²)	552024-18120H Price gr. A121 (m ²)	552024-41550HK² Price gr. A235 (m ²)	552024-12050H² Price gr. A217 (m ²)	552024-42550HK² Price gr. A217 (m ²)
active salmon	552025-18210H⁴ Price gr. A187 (m ²)	552025-12020H^{2/4} Price gr. A217 (m ²)	552025-18120H^{2/4} Price gr. A151 (m ²)	552025-41550HK^{2/4} Price gr. A235 (m ²)	552025-12050H^{2/4} Price gr. A217 (m ²)	552025-42550HK^{2/4} Price gr. A217 (m ²)
light salmon	552026-18210H Price gr. A187 (m ²)	552026-12020H² Price gr. A217 (m ²)	552026-18120H Price gr. A121 (m ²)	552026-41550HK² Price gr. A235 (m ²)	552026-12050H² Price gr. A217 (m ²)	552026-42550HK² Price gr. A217 (m ²)
medium salmon	552027-18210H Price gr. A187 (m ²)	552027-12020H² Price gr. A217 (m ²)	552027-18120H² Price gr. A151 (m ²)	552027-41550HK² Price gr. A235 (m ²)	552027-12050H Price gr. A187 (m ²)	552027-42550HK² Price gr. A217 (m ²)
dark salmon	552028-18210H² Price gr. A217 (m ²)	552028-12020H² Price gr. A217 (m ²)	552028-18120H² Price gr. A151 (m ²)	552028-41550HK² Price gr. A235 (m ²)	552028-12050H² Price gr. A217 (m ²)	552028-42550HK² Price gr. A217 (m ²)
active oxide red	552029-18210H Price gr. A187 (m ²)	552029-12020H² Price gr. A217 (m ²)	552029-18120H Price gr. A121 (m ²)	552029-41550HK² Price gr. A235 (m ²)	552029-12050H Price gr. A187 (m ²)	552029-42550HK² Price gr. A217 (m ²)
light oxide red	552030-18210H² Price gr. A217 (m ²)	552030-12020H² Price gr. A217 (m ²)	552030-18120H² Price gr. A151 (m ²)	552030-41550HK² Price gr. A235 (m ²)	552030-12050H Price gr. A187 (m ²)	552030-42550HK² Price gr. A217 (m ²)
medium oxide red	552031-18210H Price gr. A187 (m ²)	552031-12020H² Price gr. A217 (m ²)	552031-18120H² Price gr. A151 (m ²)	552031-41550HK² Price gr. A235 (m ²)	552031-12050H Price gr. A187 (m ²)	552031-42550HK² Price gr. A217 (m ²)
dark oxide red	552032-18210H Price gr. A187 (m ²)	552032-12020H² Price gr. A217 (m ²)	552032-18120H Price gr. A121 (m ²)	552032-41550HK² Price gr. A235 (m ²)	552032-12050H² Price gr. A217 (m ²)	552032-42550HK² Price gr. A217 (m ²)

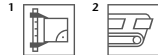

- ³ Overglazed edges / corners, refer to page 149
- ⁴ Color deviations from the standard due to production reasons are possible.
- ⁵ Supplied as double-tiles; to be broken by customer.

Floor/Wall Tiles

6.2 x 25 cm^{3/4}



12.5 x 12.5 cm^{3/4}

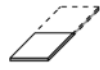

12.5 x 25 cm³



12.5 x 50 cm¹

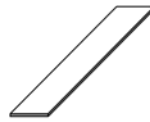

25 x 25 cm³



25 x 50 cm¹

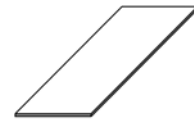

	18210H	12020H	18120H	41550HK	12050H	42550HK	Model number
	6.2 x 25 / 2 1/2 x 10	12.5 x 12.5 / 5 x 5	12.5 x 25 / 5 x 10	12.5 x 50 / 5 x 20	25 x 25 / 10 x 10	25 x 50 / 10 x 20	Nom. dim. - cm/in
	56 x 244 x 6 mm	119 x 119 x 6 mm	119 x 244 x 6 mm	119 x 494 x 8 mm	244 x 244 x 6 mm	244 x 494 x 8 mm	Work size
	smooth, silky-matt ⁶	smooth, silky-matt ⁶	smooth, silky-matt ⁶	smooth, silky-matt ⁶	smooth, silky-matt ⁶	smooth, silky-matt ⁶	Surface
	64.000	64.000	32.000	16.000	16.000	8.000	m ² - pieces
	10.880	12.160	12.160	17.040	12.800	17.040	m ² - kg
	88	88	44	8	18	9	Bundle - pieces
	1.375	1.375	1.375	0.500	1.125	1.125	Bundle - m ²
	14.960	16.720	16.720	8.520	14.400	19.170	Bundle - kg
	132.000	115.500	115.500	55.000	91.125	40.500	Pallet - m ²
	1,436.160	1,404.480	1,404.480	937.200	1,166.400	690.120	Pallet - kg
	Alb	Alb	Alb	Alb	Alb	Alb	Product standard
	552033-18210H	<i>552033-12020H²</i>	552033-18120H	<i>552033-41550HK²</i>	<i>552033-12050H²</i>	<i>552033-42550HK²</i>	2
	Price gr. A187 (m ²)	Price gr. A217 (m ²)	Price gr. A121 (m ²)	Price gr. A235 (m ²)	Price gr. A217 (m ²)	Price gr. A217 (m ²)	active stone grey <input type="checkbox"/> VO
	<i>552034-18210H²</i>	<i>552034-12020H²</i>	<i>552034-18120H²</i>	<i>552034-41550HK²</i>	<i>552034-12050H²</i>	<i>552034-42550HK²</i>	4
	Price gr. A217 (m ²)	Price gr. A217 (m ²)	Price gr. A151 (m ²)	Price gr. A235 (m ²)	Price gr. A217 (m ²)	Price gr. A217 (m ²)	light stone grey <input type="checkbox"/> VO
	552035-18210H	552035-12020H	552035-18120H	<i>552035-41550HK²</i>	<i>552035-12050H²</i>	<i>552035-42550HK²</i>	3
	Price gr. A187 (m ²)	Price gr. A187 (m ²)	Price gr. A121 (m ²)	Price gr. A235 (m ²)	Price gr. A217 (m ²)	Price gr. A217 (m ²)	medium stone grey <input type="checkbox"/> VO
	<i>552036-18210H²</i>	<i>552036-12020H²</i>	552036-18120H	<i>552036-41550HK²</i>	<i>552036-12050H²</i>	<i>552036-42550HK²</i>	2
	Price gr. A217 (m ²)	Price gr. A217 (m ²)	Price gr. A121 (m ²)	Price gr. A235 (m ²)	Price gr. A217 (m ²)	Price gr. A217 (m ²)	dark stone grey <input type="checkbox"/> VO
	<i>552037-18210H²</i>	<i>552037-12020H²</i>	552037-18120H	<i>552037-41550HK²</i>	<i>552037-12050H²</i>	<i>552037-42550HK²</i>	2
	Price gr. A217 (m ²)	Price gr. A217 (m ²)	Price gr. A121 (m ²)	Price gr. A235 (m ²)	Price gr. A217 (m ²)	Price gr. A217 (m ²)	active sand-grey <input type="checkbox"/> VO
	552038-18210H	552038-12020H	552038-18120H	<i>552038-41550HK²</i>	<i>552038-12050H</i>	<i>552038-42550HK²</i>	4
	Price gr. A187 (m ²)	Price gr. A187 (m ²)	Price gr. A121 (m ²)	Price gr. A235 (m ²)	Price gr. A187 (m ²)	Price gr. A217 (m ²)	light sand-grey <input type="checkbox"/> VO
	<i>552039-18210H²</i>	<i>552039-12020H²</i>	552039-18120H	<i>552039-41550HK²</i>	<i>552039-12050H²</i>	<i>552039-42550HK²</i>	3
	Price gr. A217 (m ²)	Price gr. A217 (m ²)	Price gr. A121 (m ²)	Price gr. A235 (m ²)	Price gr. A217 (m ²)	Price gr. A217 (m ²)	medium sand-grey <input type="checkbox"/> VO
	<i>552040-18210H²</i>	<i>552040-12020H²</i>	552040-18120H	<i>552040-41550HK²</i>	<i>552040-12050H²</i>	552040-42550HK	2
	Price gr. A217 (m ²)	Price gr. A217 (m ²)	Price gr. A121 (m ²)	Price gr. A235 (m ²)	Price gr. A217 (m ²)	Price gr. A187 (m ²)	dark sand-grey <input type="checkbox"/> VO
	<i>717i-18210H²</i>	<i>717i-12020H²</i>	<i>717i-18120H²</i>	<i>717i-41550HK²</i>	<i>717i-12050H²</i>	<i>717i-42550HK²</i>	1
	Price gr. A217 (m ²)	Price gr. A217 (m ²)	Price gr. A151 (m ²)	Price gr. A235 (m ²)	Price gr. A217 (m ²)	Price gr. A217 (m ²)	black glossy <input type="checkbox"/> VO
	<i>151i-18210H²</i>	<i>151i-12020H²</i>	<i>151i-18120H²</i>	<i>151i-41550HK²</i>	<i>151i-12050H²</i>	<i>151i-42550HK²</i>	1
	Price gr. A217 (m ²)	Price gr. A217 (m ²)	Price gr. A151 (m ²)	Price gr. A235 (m ²)	Price gr. A217 (m ²)	Price gr. A217 (m ²)	orange glossy <input type="checkbox"/> VO
	<i>150i-18210H²</i>	<i>150i-12020H²</i>	<i>150i-18120H²</i>	<i>150i-41550HK²</i>	<i>150i-12050H²</i>	<i>150i-42550HK²</i>	2
	Price gr. A217 (m ²)	Price gr. A217 (m ²)	Price gr. A151 (m ²)	Price gr. A235 (m ²)	Price gr. A217 (m ²)	Price gr. A217 (m ²)	lemon-yellow <input type="checkbox"/> VO
	<i>154i-18210H²</i>	<i>154i-12020H²</i>	<i>154i-18120H²</i>	<i>154i-41550HK²</i>	<i>154i-12050H²</i>	<i>154i-42550HK²</i>	1
	Price gr. A217 (m ²)	Price gr. A217 (m ²)	Price gr. A151 (m ²)	Price gr. A235 (m ²)	Price gr. A217 (m ²)	Price gr. A217 (m ²)	glossy <input type="checkbox"/> VO
	<i>144-18210^{2/5}</i>	<i>144-12020^{2/5}</i>	<i>144-18120^{2/5}</i>	<i>144-41550K^{2/5}</i>	<i>144-12050^{2/5}</i>	<i>144-42550K^{2/5}</i>	1
	Price gr. A217 (m ²)	Price gr. A217 (m ²)	Price gr. A151 (m ²)	Price gr. A235 (m ²)	Price gr. A217 (m ²)	Price gr. A217 (m ²)	contrasting red <input type="checkbox"/> VO
	<i>152i-18210H²</i>	<i>152i-12020H²</i>	<i>152i-18120H²</i>	<i>152i-41550HK²</i>	<i>152i-12050H²</i>	<i>152i-42550HK²</i>	2
	Price gr. A217 (m ²)	Price gr. A217 (m ²)	Price gr. A151 (m ²)	Price gr. A235 (m ²)	Price gr. A217 (m ²)	Price gr. A217 (m ²)	glossy <input type="checkbox"/> VO
	<i>153i-18210H²</i>	<i>153i-12020H²</i>	<i>153i-18120H²</i>	<i>153i-41550HK²</i>	<i>153i-12050H²</i>	<i>153i-42550HK²</i>	1
	Price gr. A217 (m ²)	Price gr. A217 (m ²)	Price gr. A151 (m ²)	Price gr. A235 (m ²)	Price gr. A217 (m ²)	Price gr. A217 (m ²)	intense blue <input type="checkbox"/> VO
							apple-green <input type="checkbox"/> VO
							glossy <input type="checkbox"/> VO
							violet glossy <input type="checkbox"/> VO



¹ Overglazed edges / corners, refer to page 149

² Supplied as double-tiles; to be broken by customer.

³ without Hytect coating

⁴ Exception: contrasting colors black, orange, lemon-yellow, contrasting red, intense blue, apple-green, violet: smooth, glossy



Overglazed edges available on request:			overglazed edges	Example: Standard model no. 18120 = 119 x 244 x 6 mm, model no. 18123 = overglazed corner left
Replace last figure 0 of Standard model no. by 3 = corner left	... 4 = corner right		



Solebad, Werne, Germany / Architect: Geising + Böker GmbH, Büro Vechta
Photo: Jochen Stüber





Slip resistance "B"

-/B



91 white / neutral 10 (active white)



553119 neutral 9 (white-grey)



553118 neutral 8 (light-grey)



553117 neutral 7 (pebble-grey)



553116 neutral 6 (pearl grey)



553115 neutral 5 (basalt grey)



553114 neutral 4 (graphite black)



553113 neutral 3 (asphalt black)



553112 neutral 2 (anthracite)



340 black / neutral 1 (deep black)

-/B



553004 dark azure



553008 dark blue



553016 dark green



553019 medium yellow



553023 medium ochre



553027 medium salmon

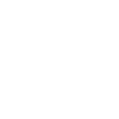

553031 medium oxide red



553036 dark stone grey



553040 dark sand grey



553003 medium azure



553007 medium blue



553011 medium turquoise



553015 medium green



553019 medium yellow



553023 medium ochre



553027 medium salmon



553031 medium oxide red



553035 medium stone grey



553039 medium sand grey



553002 light azure



553006 light blue



553010 light turquoise



553014 light green



553018 light yellow



553026 light salmon



553034 light stone grey

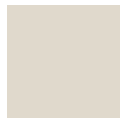

553038 light sand grey

-/B



553001 active azure



553033 active stone grey



553037 active sand grey

-/B



77 contrasting red



553033 active stone grey



553037 active sand grey



Floor tile
12.5 x 12.5 cm, 5 x 5 in, smooth, -/B



Floor tile
12.5 x 25 cm, 5 x 10 in, smooth, -/B



Floor tile
25 x 25 cm, 10 x 10 in, smooth, -/B

On request, other colors of the series Chroma are also available as non-slip glazes with a joint width of 6 mm.

Slip resistance „B“

Floor Tiles²

12.5 x 12.5 cm³



12.5 x 25 cm



25 x 25 cm



	32020H	38110H	32050H	Model number
	12.5 x 12.5 / 5 x 5	12.5 x 25 / 5 x 10	25 x 25 / 10 x 10	Nom. dim. - cm/in
	119 x 119 x 8 mm	119 x 244 x 8 mm	244 x 244 x 8 mm	Work size
	smooth, silky-matt	smooth, silky-matt	smooth, silky-matt	Surface
	64.000	32.000	16.000	m ² - pieces
	15.360	15.680	16.960	m ² - kg
	66	33	14	Bundle - pieces
	1.031	1.031	0.875	Bundle - m ²
	15.840	16.170	14.840	Bundle - kg
	86.625	86.625	70.875	Pallet - m ²
	1,330.560	1,358.280	1,202.040	Pallet - kg
	Alb	Alb	Alb	Product standard
	-/B ☒	-/B ☒	-/B ☒	Slip resistance
	2	2	2	Stress group
	91i-32020H	91i-38110H	91i-32050H	neutral 10
	Price gr. A217 (m ²)	Price gr. A199 (m ²)	Price gr. A217 (m ²)	(active white) <input type="checkbox"/> VO
	340i-32020H	340i-38110H	340i-32050H	neutral 1
	Price gr. A217 (m ²)	Price gr. A199 (m ²)	Price gr. A217 (m ²)	(deep black) <input type="checkbox"/> VO
	553001-32020H	553001-38110H	553001-32050H	active azure <input type="checkbox"/> VO
	Price gr. A217 (m ²)	Price gr. A199 (m ²)	Price gr. A217 (m ²)	
	553002-32020H	553002-38110H	553002-32050H	light azure <input type="checkbox"/> VO
	Price gr. A217 (m ²)	Price gr. A199 (m ²)	Price gr. A217 (m ²)	
	553003-32020H	553003-38110H	553003-32050H	medium azure <input type="checkbox"/> VO
	Price gr. A217 (m ²)	Price gr. A199 (m ²)	Price gr. A217 (m ²)	
	553004-32020H	553004-38110H	553004-32050H	dark azure <input type="checkbox"/> VO
	Price gr. A217 (m ²)	Price gr. A199 (m ²)	Price gr. A217 (m ²)	
	553006-32020H	553006-38110H	553006-32050H	light blue <input type="checkbox"/> VO
	Price gr. A217 (m ²)	Price gr. A199 (m ²)	Price gr. A217 (m ²)	
	553007-32020H	553007-38110H	553007-32050H	medium blue <input type="checkbox"/> VO
	Price gr. A217 (m ²)	Price gr. A199 (m ²)	Price gr. A217 (m ²)	
	553008-32020H	553008-38110H¹	553008-32050H¹	dark blue <input type="checkbox"/> VO
	Price gr. A217 (m ²)	Price gr. A199 (m ²)	Price gr. A217 (m ²)	
	553010-32020H	553010-38110H	553010-32050H¹	light turquoise <input type="checkbox"/> VO
	Price gr. A217 (m ²)	Price gr. A199 (m ²)	Price gr. A217 (m ²)	
	553011-32020H	553011-38110H	553011-32050H	medium turquoise <input type="checkbox"/> VO
	Price gr. A217 (m ²)	Price gr. A199 (m ²)	Price gr. A217 (m ²)	
	553014-32020H	553014-38110H¹	553014-32050H¹	light green <input type="checkbox"/> VO
	Price gr. A217 (m ²)	Price gr. A199 (m ²)	Price gr. A217 (m ²)	
	553015-32020H	553015-38110H	553015-32050H	medium green <input type="checkbox"/> VO
	Price gr. A217 (m ²)	Price gr. A199 (m ²)	Price gr. A217 (m ²)	
	553016-32020H	553016-38110H	553016-32050H	dark green <input type="checkbox"/> VO
	Price gr. A217 (m ²)	Price gr. A199 (m ²)	Price gr. A217 (m ²)	
	553018-32020H¹	553018-38110H¹	553018-32050H¹	light yellow <input type="checkbox"/> VO
	Price gr. A217 (m ²)	Price gr. A199 (m ²)	Price gr. A217 (m ²)	
	553019-32020H	553019-38110H	553019-32050H	medium yellow <input type="checkbox"/> VO
	Price gr. A217 (m ²)	Price gr. A199 (m ²)	Price gr. A217 (m ²)	
	553023-32020H¹	553023-38110H	553023-32050H	medium ochre <input type="checkbox"/> VO
	Price gr. A217 (m ²)	Price gr. A199 (m ²)	Price gr. A217 (m ²)	
	553026-32020H¹	553026-38110H¹	553026-32050H¹	light salmon <input type="checkbox"/> VO
	Price gr. A217 (m ²)	Price gr. A199 (m ²)	Price gr. A217 (m ²)	
	553027-32020H¹	553027-38110H	553027-32050H	medium salmon <input type="checkbox"/> VO
	Price gr. A217 (m ²)	Price gr. A199 (m ²)	Price gr. A217 (m ²)	
	553031-32020H	553031-38110H¹	553031-32050H¹	medium oxide red <input type="checkbox"/> VO
	Price gr. A217 (m ²)	Price gr. A199 (m ²)	Price gr. A217 (m ²)	
	553033-32020H¹	553033-38110H¹	553033-32050H¹	active stone grey <input type="checkbox"/> VO
	Price gr. A217 (m ²)	Price gr. A199 (m ²)	Price gr. A217 (m ²)	
	553034-32020H	553034-38110H¹	553034-32050H¹	light stone grey <input type="checkbox"/> VO
	Price gr. A217 (m ²)	Price gr. A199 (m ²)	Price gr. A217 (m ²)	
	553035-32020H	553035-38110H	553035-32050H¹	medium stone grey <input type="checkbox"/> VO
	Price gr. A217 (m ²)	Price gr. A199 (m ²)	Price gr. A217 (m ²)	
	553036-32020H	553036-38110H	553036-32050H¹	dark stone grey <input type="checkbox"/> VO
	Price gr. A217 (m ²)	Price gr. A199 (m ²)	Price gr. A217 (m ²)	



¹ Rounded edges / corners refer to page 157

² Supplied as double-tiles; to be broken by customer.



Slip resistance „B“

Floor Tiles²

12.5 x 12.5 cm³

12.5 x 25 cm

25 x 25 cm



Model number	32020H	38110H	32050H			
Nom. dim. - cm/in	12.5 x 12,5 / 5 x 5	12.5 x 25 / 5 x 10	25 x 25 / 10 x 10			
Work size	119 x 119 x 8 mm	119 x 244 x 8 mm	244 x 244 x 8 mm			
Surface	smooth, silky-matt	smooth, silky-matt	smooth, silky-matt			
m ² - pieces	64.000	32.000	16.000			
m ² - kg	15.360	15.680	16.960			
Bundle - pieces	66	33	14			
Bundle - m ²	1.031	1.031	0.875			
Bundle - kg	15.840	16.170	14.840			
Pallet - m ²	86.625	86.625	70.875			
Pallet - kg	1,330.500	1,358.280	1,202.040			
Product standard	Alb	Alb	Alb			
Slip resistance	-/B ☒	-/B ☒	-/B ☒			
Stress group	2	2	2			
active sand-grey <input type="checkbox"/>	553037-32020H ¹ Price gr. A217 (m ²)	553037-38110H ¹ Price gr. A199 (m ²)	553037-32050H ¹ Price gr. A217 (m ²)			
light sand-grey <input type="checkbox"/>	553038-32020H Price gr. A217 (m ²)	553038-38110H Price gr. A199 (m ²)	553038-32050H ¹ Price gr. A217 (m ²)			
medium sand-grey <input type="checkbox"/>	553039-32020H Price gr. A217 (m ²)	553039-38110H ¹ Price gr. A199 (m ²)	553039-32050H ¹ Price gr. A217 (m ²)			
dark sand-grey <input type="checkbox"/>	553040-32020H Price gr. A217 (m ²)	553040-38110H ¹ Price gr. A199 (m ²)	553040-32050H ¹ Price gr. A217 (m ²)			
neutral 9 (white grey) <input type="checkbox"/>	553119-32020H ¹ Price gr. A217 (m ²)	553119-38110H ¹ Price gr. A199 (m ²)	553119-32050H Price gr. A217 (m ²)			
neutral 8 (light-grey) <input type="checkbox"/>	553118-32020H Price gr. A217 (m ²)	553118-38110H ¹ Price gr. A199 (m ²)	553118-32050H Price gr. A217 (m ²)			
neutral 7 (pebble grey) <input type="checkbox"/>	553117-32020H Price gr. A217 (m ²)	553117-38110H Price gr. A199 (m ²)	553117-32050H Price gr. A217 (m ²)			
neutral 6 (pearl grey) <input type="checkbox"/>	553116-32020H ¹ Price gr. A217 (m ²)	553116-38110H Price gr. A199 (m ²)	553116-32050H ¹ Price gr. A217 (m ²)			
neutral 5 (basalt grey) <input type="checkbox"/>	553115-32020H ¹ Price gr. A217 (m ²)	553115-38110H ¹ Price gr. A199 (m ²)	553115-32050H ¹ Price gr. A217 (m ²)			
neutral 4 (graphite black) <input type="checkbox"/>	553114-32020H ¹ Price gr. A217 (m ²)	553114-38110H ¹ Price gr. A199 (m ²)	553114-32050H Price gr. A217 (m ²)			
neutral 3 (asphalt black) <input type="checkbox"/>	553113-32020H Price gr. A217 (m ²)	553113-38110H Price gr. A199 (m ²)	553113-32050H Price gr. A217 (m ²)			
neutral 2 (anthracite) <input type="checkbox"/>	553112-32020H Price gr. A217 (m ²)	553112-38110H Price gr. A199 (m ²)	553112-32050H Price gr. A217 (m ²)			
contrasting red <input type="checkbox"/>	77i-32020H Price gr. A217 (m ²)	77i-38110H Price gr. A199 (m ²)	77i-32050H Price gr. A217 (m ²)			



² Rounded edges / corners refer to page 157

³ Supplied as double-tiles; to be broken by customer.

Slip resistance „B“ – rounded edges/corners^{1/2}

Floor Tiles

12.5 x 12.5 cm



12.5 x 12.5 cm



12.5 x 25 cm



12.5 x 25 cm



12.5 x 25 cm



12.5 x 25 cm



rounded edge

rounded corner

short side rounded

long side rounded

rounded corner left

rounded corner right

32025H	32027H	38115H	38116H	38117H	38118H	Model number
12.5 x 12.5 / 5 x 5	12.5 x 12.5 / 5 x 5	12.5 x 25 / 5 x 10	12.5 x 25 / 5 x 10	12.5 x 25 / 5 x 10	12.5 x 25 / 5 x 10	Nom. dim. - cm/in
119 x 119 x 8 mm	119 x 119 x 8 mm	119 x 244 x 8 mm	119 x 244 x 8 mm	119 x 244 x 8 mm	119 x 244 x 8 mm	Work size
smooth, silky-matt	smooth, silky-matt	smooth, silky-matt	smooth, silky-matt	smooth, silky-matt	smooth, silky-matt	Surface
0.240	0.240	0.490	0.490	0.490	0.490	m ² - pieces
66	66	33	33	33	33	m ² - kg
15.840	15.840	16.170	16.170	16.170	16.170	Bundle - pieces
						Bundle - m ²
						Bundle - kg
						Pallet - m ²
						Pallet - kg
Alb	Alb	Alb	Alb	Alb	Alb	Product standard
-/B	-/B	-/B	-/B	-/B	-/B	Slip resistance
2	2	2	2	2	2	Stress group
91i-32025H	91i-32027H	91i-38115H	91i-38116H	91i-38117H	91i-38118H	neutral 10
Price gr. A410 (pce.)	Price gr. A410 (pce.)	Price gr. A416 (pce.)	Price gr. A416 (pce.)	Price gr. A416 (pce.)	Price gr. A416 (pce.)	(active white) <input type="checkbox"/>
340i-32025H	340i-32027H	340i-38115H	340i-38116H	340i-38117H	340i-38118H	neutral 1
Price gr. A410 (pce.)	Price gr. A410 (pce.)	Price gr. A416 (pce.)	Price gr. A416 (pce.)	Price gr. A416 (pce.)	Price gr. A416 (pce.)	(deep black) <input type="checkbox"/>
553001-32025H	553001-32027H	553001-38115H	553001-38116H	553001-38117H	553001-38118H	active azure <input type="checkbox"/>
Price gr. A410 (pce.)	Price gr. A410 (pce.)	Price gr. A416 (pce.)	Price gr. A416 (pce.)	Price gr. A416 (pce.)	Price gr. A416 (pce.)	
553002-32025H	553002-32027H	553002-38115H	553002-38116H	553002-38117H	553002-38118H	light azure <input type="checkbox"/>
Price gr. A410 (pce.)	Price gr. A410 (pce.)	Price gr. A416 (pce.)	Price gr. A416 (pce.)	Price gr. A416 (pce.)	Price gr. A416 (pce.)	



Floor Tiles



rounded edge

rounded corner

32055H	32057H	Model number
25 x 25 / 10 x 10	25 x 25 / 10 x 10	Nom. dim. - cm/in
244 x 244 x 8 mm	244 x 244 x 8 mm	Work size
smooth, silky-matt	smooth, silky-matt	Surface
1.060	1.060	m ² - pieces
14	14	m ² - kg
14.840	14.840	Bundle - pieces
		Bundle - m ²
		Bundle - kg
		Pallet - m ²
		Pallet - kg
Alb	Alb	Product standard
-/B	-/B	Slip resistance
2	2	Stress group
91i-32055H	91i-32057H	neutral 10
Price gr. A434 (pce.)	Price gr. A434 (pce.)	(active white) <input type="checkbox"/>
340i-32055H	340i-32057H	neutral 1
Price gr. A434 (pce.)	Price gr. A434 (pce.)	(deep black) <input type="checkbox"/>
553001-32055H	553001-32057H	active azure <input type="checkbox"/>
Price gr. A434 (pce.)	Price gr. A434 (pce.)	
553002-32055H	553002-32057H	light azure <input type="checkbox"/>
Price gr. A434 (pce.)	Price gr. A434 (pce.)	



Rounded edges

Replace last figure 0 of Standard model no. by ...

... 7 = corner left

... 8 = corner right

overglazed edges

Example: Standard model no. 38110 = 119 x 244 x 6 mm,
model no. 38117 = rounded corner left

Slip resistance "C"

-/C



81 white / neutral 10 (active white)



554119 neutral 9 (white-grey)



554118 neutral 8 (light-grey)



554117 neutral 7 (pebble-grey)



554113 neutral 3 (asphalt black)



554111 black / neutral 1 (deep black)

-/C



554004 dark azure



554008 dark blue



554016 dark green



554036 dark stone grey



554040 dark sand grey



554003 medium azure



554007 medium blue



554011 medium turquoise



554015 medium green



554019 medium yellow



554023 medium ochre



554027 medium salmon



554031 medium oxide red



554035 medium stone grey



554039 medium sand grey



554002 light azure

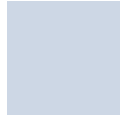

554006 light blue



554010 light turquoise



554014 light green



554026 light salmon



554038 light sand grey

-/C



554001 active azure

-/C



78 contrasting red



Floor tile
12.5 x 12.5 cm, 5 x 5 in, structured, -/C



Floor tile
12.5 x 25 cm, 5 x 10 in, structured, -/C



Floor tile
25 x 25 cm, 10 x 10 in, structured, -/C

On request, other colors of the series Chroma are also available as non-slip glazes with a joint width of 6 mm.

Slip resistance „C“
Floor Tiles²

12.5 x 12.5 cm³



12.5 x 25 cm



25 x 25 cm



				32020H	38110H	32050H	Model number
				12.5 x 12.5 / 5 x 5	12.5 x 25 / 5 x 10	25 x 25 / 10 x 10	Nom. dim. - cm/in
				119 x 119 x 8 mm	119 x 244 x 8 mm	244 x 244 x 8 mm	Work size
				smooth, silky-matt	smooth, silky-matt	smooth, silky-matt	Surface
				64.000	32.000	16.000	m ² - pieces
				15.360	15.680	16.960	m ² - kg
				66	33	14	Bundle - pieces
				1.031	1.031	0.875	Bundle - m ²
				15.840	16.170	14.840	Bundle - kg
				86.625	86.625	70.875	Pallet - m ²
				1,330.560	1,358.280	1,202.040	Pallet - kg
				Alb	Alb	Alb	Product standard
				-/C	-/C	-/C	Slip resistance
				2	2	2	Stress group
				81i-32020H	81i-38110H	81i-32050H	neutral 10
				Price gr. A217 (m ²)	Price gr. A199 (m ²)	Price gr. A217 (m ²)	(active white) <input type="checkbox"/>
				554111-32020H	554111-38110H	554111-32050H¹	neutral 1
				Price gr. A217 (m ²)	Price gr. A199 (m ²)	Price gr. A217 (m ²)	(deep black) <input type="checkbox"/>
				554001-32020H	554001-38110H	554001-32050H¹	active azure <input type="checkbox"/>
				Price gr. A217 (m ²)	Price gr. A199 (m ²)	Price gr. A217 (m ²)	
				554002-32020H	554002-38110H	554002-32050H	light azure <input type="checkbox"/>
				Price gr. A217 (m ²)	Price gr. A199 (m ²)	Price gr. A217 (m ²)	
				554003-32020H	554003-38110H	554003-32050H	medium azure <input type="checkbox"/>
				Price gr. A217 (m ²)	Price gr. A199 (m ²)	Price gr. A217 (m ²)	
				554004-32020H	554004-38110H	554004-32050H¹	dark azure <input type="checkbox"/>
				Price gr. A217 (m ²)	Price gr. A199 (m ²)	Price gr. A217 (m ²)	
				554006-32020H	554006-38110H	554006-32050H¹	light blue <input type="checkbox"/>
				Price gr. A217 (m ²)	Price gr. A199 (m ²)	Price gr. A217 (m ²)	
				554007-32020H	554007-38110H	554007-32050H¹	medium blue <input type="checkbox"/>
				Price gr. A217 (m ²)	Price gr. A199 (m ²)	Price gr. A217 (m ²)	
				554008-32020H	554008-38110H	554008-32050H¹	dark blue <input type="checkbox"/>
				Price gr. A217 (m ²)	Price gr. A199 (m ²)	Price gr. A217 (m ²)	
				554010-32020H	554010-38110H	554010-32050H¹	light turquoise <input type="checkbox"/>
				Price gr. A217 (m ²)	Price gr. A199 (m ²)	Price gr. A217 (m ²)	
				554011-32020H	554011-38110H	554011-32050H¹	medium turquoise <input type="checkbox"/>
				Price gr. A217 (m ²)	Price gr. A199 (m ²)	Price gr. A217 (m ²)	
				554014-32020H	554014-38110H¹	554014-32050H¹	light green <input type="checkbox"/>
				Price gr. A217 (m ²)	Price gr. A199 (m ²)	Price gr. A217 (m ²)	
				554015-32020H	554015-38110H¹	554015-32050H¹	medium green <input type="checkbox"/>
				Price gr. A217 (m ²)	Price gr. A199 (m ²)	Price gr. A217 (m ²)	
				554016-32020H	554016-38110H	554016-32050H	dark green <input type="checkbox"/>
				Price gr. A217 (m ²)	Price gr. A199 (m ²)	Price gr. A217 (m ²)	
				554019-32020H	554019-38110H	554019-32050H¹	medium yellow <input type="checkbox"/>
				Price gr. A217 (m ²)	Price gr. A199 (m ²)	Price gr. A217 (m ²)	
				554023-32020H	554023-38110H	554023-32050H	medium ochre <input type="checkbox"/>
				Price gr. A217 (m ²)	Price gr. A199 (m ²)	Price gr. A217 (m ²)	
				554026-32020H¹	554026-38110H¹	554026-32050H¹	light salmon <input type="checkbox"/>
				Price gr. A217 (m ²)	Price gr. A199 (m ²)	Price gr. A217 (m ²)	
				554027-32020H	554027-38110H	554027-32050H¹	medium salmon <input type="checkbox"/>
				Price gr. A217 (m ²)	Price gr. A199 (m ²)	Price gr. A217 (m ²)	
				554031-32020H	554031-38110H	554031-32050H¹	medium oxide red <input type="checkbox"/>
				Price gr. A217 (m ²)	Price gr. A199 (m ²)	Price gr. A217 (m ²)	
				554035-32020H	554035-38110H	554035-32050H¹	medium stone grey <input type="checkbox"/>
				Price gr. A217 (m ²)	Price gr. A199 (m ²)	Price gr. A217 (m ²)	
				554036-32020H	554036-38110H	554036-32050H¹	dark stone grey <input type="checkbox"/>
				Price gr. A217 (m ²)	Price gr. A199 (m ²)	Price gr. A217 (m ²)	
				554038-32020H	554038-38110H	554038-32050H	light sand-grey <input type="checkbox"/>
				Price gr. A217 (m ²)	Price gr. A199 (m ²)	Price gr. A217 (m ²)	
				554039-32020H	554039-38110H	554039-32050H¹	medium sand-grey <input type="checkbox"/>
				Price gr. A217 (m ²)	Price gr. A199 (m ²)	Price gr. A217 (m ²)	
				554040-32020H	554040-38110H	554040-32050H¹	dark sand-grey <input type="checkbox"/>
				Price gr. A217 (m ²)	Price gr. A199 (m ²)	Price gr. A217 (m ²)	
				554119-32020H¹	554119-38110H	554119-32050H¹	neutral 9
				Price gr. A217 (m ²)	Price gr. A199 (m ²)	Price gr. A217 (m ²)	(white grey) <input type="checkbox"/>
				554118-32020H	554118-38110H	554118-32050H¹	neutral 8
				Price gr. A217 (m ²)	Price gr. A199 (m ²)	Price gr. A217 (m ²)	(light-grey) <input type="checkbox"/>
				554117-32020H	554117-38110H	554117-32050H	neutral 7
				Price gr. A217 (m ²)	Price gr. A199 (m ²)	Price gr. A217 (m ²)	(pebble grey) <input type="checkbox"/>
				554113-32020H	554113-38110H	554113-32050H	neutral 3
				Price gr. A217 (m ²)	Price gr. A199 (m ²)	Price gr. A217 (m ²)	(asphalt black) <input type="checkbox"/>
				78i-32020H	78i-38110H	78i-32050H¹	contrasting red <input type="checkbox"/>
				Price gr. A217 (m ²)	Price gr. A199 (m ²)	Price gr. A217 (m ²)	



² Rounded edges / corners refer to page 160

³ Supplied as double-tiles; to be broken by customer.



Slip resistance „C“ – rounded edges / corners^{1/2}

Floor Tiles

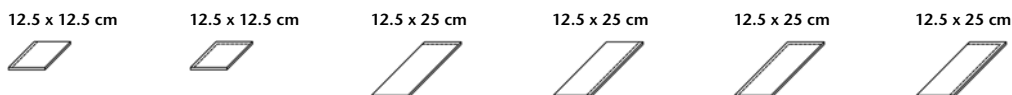

rounded edge rounded corner short side rounded long side rounded rounded corner left rounded corner right

Model number	32025H	32027H	38115H	38116H	38117H	38118H
Nom. dim. - cm/in	12.5 x 12.5 / 5 x 5	12.5 x 12.5 / 5 x 5	12.5 x 25 / 5 x 10	12.5 x 25 / 5 x 10	12.5 x 25 / 5 x 10	12.5 x 25 / 5 x 10
Work size	119 x 119 x 8 mm	119 x 119 x 8 mm	119 x 244 x 8 mm	119 x 244 x 8 mm	119 x 244 x 8 mm	119 x 244 x 8 mm
Surface	structured, silky-matt	structured, silky-matt	structured, silky-matt	structured, silky-matt	structured, silky-matt	structured, silky-matt
m ² - pieces						
m ² - kg	0.240	0.240	0.490	0,490	0.490	0.490
Bundle - pieces	66	66	33	33	33	33
Bundle - m ²						
Bundle - kg	15.840	15.840	16.170	16.170	16.170	16.170
Pallet - m ²						
Pallet - kg						
Product standard	Alb	Alb	Alb	Alb	Alb	Alb
Slip resistance	-/C ☒	-/C ☒	-/C ☒	-/C ☒	-/C ☒	-/C ☒
Stress group	2	2	2	2	2	2
neutral 10	81i-32025H	81i-32027H	81i-38115H	81i-38116H	81i-38117H	81i-38118H
(active white) <input type="checkbox"/>	Price gr. A410 (pce.)	Price gr. A410 (pce.)	Price gr. A416 (pce.)	Price gr. A416 (pce.)	Price gr. A416 (pce.)	Price gr. A416 (pce.)
neutral 1	554111-32025H	554111-32027H	554111-38115H	554111-38116H	554111-38117H	554111-38118H
(deep black) <input type="checkbox"/>	Price gr. A410 (pce.)	Price gr. A410 (pce.)	Price gr. A416 (pce.)	Price gr. A416 (pce.)	Price gr. A416 (pce.)	Price gr. A416 (pce.)
active azure <input type="checkbox"/>	554001-32025H	554001-32027H	554001-38115H	554001-38116H	554001-38117H	554001-38118H
	Price gr. A410 (pce.)	Price gr. A410 (pce.)	Price gr. A416 (pce.)	Price gr. A416 (pce.)	Price gr. A416 (pce.)	Price gr. A416 (pce.)
light azure <input type="checkbox"/>	554002-32025H	554002-32027H	554002-38115H	554002-38116H	554002-38117H	554002-38118H
	Price gr. A410 (pce.)	Price gr. A410 (pce.)	Price gr. A416 (pce.)	Price gr. A416 (pce.)	Price gr. A416 (pce.)	Price gr. A416 (pce.)

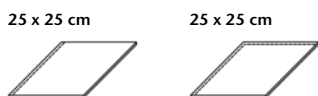

rounded edge rounded corner

Model number	32055H	32057H				
Nom. dim. - cm/in	25 x 25 / 10 x 10	25 x 25 / 10 x 10				
Work size	244 x 244 x 8 mm	244 x 244 x 8 mm				
Surface	structured, silky-matt	structured, silky-matt				
m ² - pieces						
m ² - kg	1.060	1.060				
Bundle - pieces	14	14				
Bundle - m ²						
Bundle - kg	14.840	14.840				
Pallet - m ²						
Pallet - kg						
Product standard	Alb	Alb				
Slip resistance	-/C ☒	-/C ☒				
Stress group	2	2				
neutral 10	81i-32055H	81i-32057H				
(active white) <input type="checkbox"/>	Price gr. A434 (pce.)	Price gr. A434 (pce.)				
neutral 1	554111-32055H	554111-32057H				
(deep black) <input type="checkbox"/>	Price gr. A434 (pce.)	Price gr. A434 (pce.)				
active azure <input type="checkbox"/>	554001-32055H	554001-32057H				
	Price gr. A434 (pce.)	Price gr. A434 (pce.)				
light azure <input type="checkbox"/>	554002-32055H	554002-32057H				
	Price gr. A434 (pce.)	Price gr. A434 (pce.)				

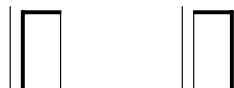

Rounded edges

Replace last figure 0 of Standard model no. by 7 = corner left	... 8 = corner right	overglazed edges	Example: Standard model no. 38110 = 119 x 244 x 6 mm, model no. 38117 = rounded corner left
--	---------------------	----------------------	------------------	---



Oasia Hotel, Singapore / Architect: WOHA Architects + Patricia Urquiola / Series: Chroma non-slip, Chroma / Photo: Infitude





Bybadet, Alesund, Norway / Architect: Invit Arkitekter AS / Photo: Tove Lauluten







R10/A R10/B R11/B



Quantum



926
white / neutral 10 (active white)



555023
medium ochre

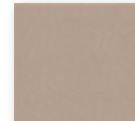

Floor/wall tile
12.5 x 12.5 cm, 5 x 5 in, smooth, R10/A



555118
neutral 8 (light-grey)



555036
dark stone grey



555035
medium stone grey

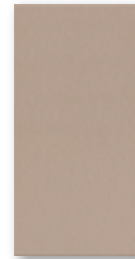

Floor/wall tile
12.5 x 25 cm, 5 x 10 in, smooth, R10/A



555117
neutral 7 (pebble-grey)



555040
dark sand grey



555039
medium sand grey



555038
light sand grey



555113
neutral 3 (asphalt black)

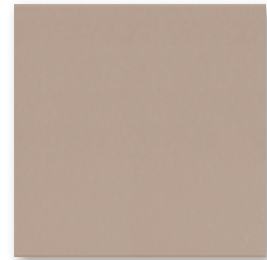

Floor/wall tile
25 x 25 cm, 10 x 10 in, smooth, R10/A



918
black / neutral 1 (deep black)

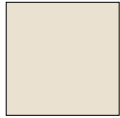

901
natural-white



Floor/wall tile
25 x 50 cm, 10 x 20 in, smooth, R10/A

Grid Profile

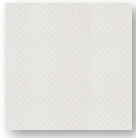

Grid profile tile
12.5 x 12.5 cm, 5 x 5 in, relief, R11/B

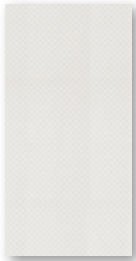

Grid profile tile
12.5 x 25 cm, 5 x 10 in, relief, R11/B

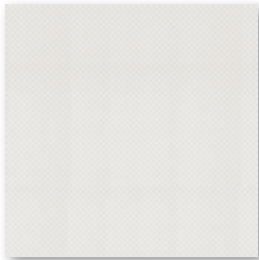

Grid profile tile
25 x 25 cm, 10 x 10 in, relief, R11/B



Grid profile tile
25 x 50 cm, 10 x 20 in, relief, R11/B

Shower Tub System

Shower tub system
Corner (one piece)
12.5 x 12.5 cm, 5 x 5 in, smooth, R10/B



Shower tub system
Strip
12.5 x 12.5 cm, 5 x 5 in
smooth, R10/B

Shower tub system
Strip
25 x 12.5 cm, 10 x 5 in
smooth, R10/B

Cove skirting, r = 12 mm
25 x 12.5 cm, 10 x 5 in, smooth



External angle,
smooth

Internal angle,
smooth

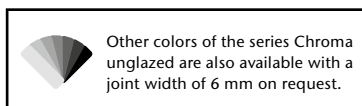

Other colors of the series Chroma unglazed are also available with a joint width of 6 mm on request.

Quantum

Floor/Wall Tiles

12,5 x 12,5 cm³



12,5 x 25 cm



25 x 25 cm



25 x 50 cm^{1/2/4}

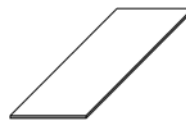

Model number	32020H	38110H	32050H	42550HK			
Nom. dim. - cm/in	12.5 x 12.5 / 5 x 5	12.5 x 25 / 5 x 10	25 x 25 / 10 x 10	25 x 50 / 10 x 20			
Work size	119 x 119 x 8 mm	119 x 244 x 8 mm	244 x 244 x 8 mm	244 x 494 x 8 mm			
Surface	smooth, silky-matt	smooth, silky-matt	smooth, silky-matt	smooth, silky-matt			
m ² - pieces	64.000	32.000	16.000	8.000			
m ² - kg	15.360	15.680	16.960	17.040			
Bundle - pieces	66	33	14	9			
Bundle - m ²	1.031	1.031	0.875	1.125			
Bundle - kg	15.840	16.170	14.840	19.170			
Pallet - m ²	86.625	86.625	70.875	40.500			
Pallet - kg	1,330.560	1,358.280	1,202.040	690.120			
Product standard	Alb	Alb	Alb	Alb			
Slip resistance	R10/A	R10/A	R10/A	R10/A			
Stress group	2	2	2	2			
neutral 10	926i-32020H	926i-38110H	926i-32050H	926i-42550HK			
(active white) <input type="checkbox"/>	Price gr. A166 (m ²)	Price gr. A166 (m ²)	Price gr. A166 (m ²)	Price gr. A178 (m ²)			
neutral 1	918i-32020H	918i-38110H	918i-32050H	918i-42550HK			
(deep black) <input type="checkbox"/>	Price gr. A166 (m ²)	Price gr. A166 (m ²)	Price gr. A166 (m ²)	Price gr. A178 (m ²)			
medium ochre <input type="checkbox"/>	<i>S55023-32020H^{2/4}</i>	<i>S55023-38110H^{2/4}</i>	<i>S55023-32050H^{2/4}</i>	<i>S55023-42550HK</i>			
	Price gr. A166 (m ²)	Price gr. A166 (m ²)	Price gr. A166 (m ²)	Price gr. A178 (m ²)			
medium stone grey <input type="checkbox"/>	<i>S55035-32020H^{2/4}</i>	<i>S55035-38110H^{2/4}</i>	<i>S55035-32050H^{2/4}</i>	<i>S55035-42550HK</i>			
	Price gr. A166 (m ²)	Price gr. A166 (m ²)	Price gr. A166 (m ²)	Price gr. A178 (m ²)			
dark stone grey <input type="checkbox"/>	<i>S55036-32020H^{2/4}</i>	<i>S55036-38110H^{2/4}</i>	<i>S55036-32050H^{2/4}</i>	<i>S55036-42550HK</i>			
	Price gr. A166 (m ²)	Price gr. A166 (m ²)	Price gr. A166 (m ²)	Price gr. A178 (m ²)			
light sand-grey <input type="checkbox"/>	<i>S55038-32020H^{2/4}</i>	<i>S55038-38110H^{2/4}</i>	<i>S55038-32050H^{2/4}</i>	<i>S55038-42550HK</i>			
	Price gr. A166 (m ²)	Price gr. A166 (m ²)	Price gr. A166 (m ²)	Price gr. A178 (m ²)			
medium sand-grey <input type="checkbox"/>	<i>S55039-32020H^{2/4}</i>	<i>S55039-38110H^{2/4}</i>	<i>S55039-32050H^{2/4}</i>	<i>S55039-42550HK</i>			
	Price gr. A166 (m ²)	Price gr. A166 (m ²)	Price gr. A166 (m ²)	Price gr. A178 (m ²)			
dark sand-grey <input type="checkbox"/>	<i>S55040-32020H^{2/4}</i>	<i>S55040-38110H^{2/4}</i>	<i>S55040-32050H^{2/4}</i>	<i>S55040-42550HK</i>			
	Price gr. A166 (m ²)	Price gr. A166 (m ²)	Price gr. A166 (m ²)	Price gr. A178 (m ²)			
neutral 3	<i>S55113-32020H^{2/4}</i>	<i>S55113-38110H^{2/4}</i>	<i>S55113-32050H^{2/4}</i>	<i>S55113-42550HK</i>			
(asphalt black) <input type="checkbox"/>	Price gr. A166 (m ²)	Price gr. A166 (m ²)	Price gr. A166 (m ²)	Price gr. A178 (m ²)			
neutral 7	<i>S55117-32020H^{2/4}</i>	<i>S55117-38110H^{2/4}</i>	<i>S55117-32050H^{2/4}</i>	<i>S55117-42550HK</i>			
(pebble grey) <input type="checkbox"/>	Price gr. A166 (m ²)	Price gr. A166 (m ²)	Price gr. A166 (m ²)	Price gr. A178 (m ²)			
neutral 8	<i>S55118-32020H^{2/4}</i>	<i>S55118-38110H^{2/4}</i>	<i>S55118-32050H^{2/4}</i>	<i>S55118-42550HK</i>			
(light-grey) <input type="checkbox"/>	Price gr. A166 (m ²)	Price gr. A166 (m ²)	Price gr. A166 (m ²)	Price gr. A178 (m ²)			
natural white <input type="checkbox"/>	901i-32020H	901i-38110H	901i-32050H	901i-42550HK			
	Price gr. A166 (m ²)	Price gr. A166 (m ²)	Price gr. A166 (m ²)	Price gr. A178 (m ²)			



³ Supplied as double-tiles; to be broken by customer.

⁴ Minimum order quantity: 200 m²

Quantum

Floor Tiles

12.5 x 12.5 cm³



12.5 x 25 cm



25 x 25 cm



25 x 50 cm^{1/2/4}

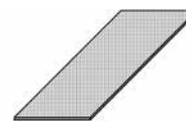

			Grid profile tile	Grid profile tile	Grid profile tile	Grid profile tile	
			32100H	34090H	32080H	42580HK	Model number
			12,5 x 12,5 / 5 x 5	12,5 x 25 / 5 x 10	25 x 25 / 10 x 10	25 x 50 / 10 x 20	Nom. dim. - cm/in
			119 x 119 x 8 mm	119 x 244 x 8 mm	244 x 244 x 8 mm	244 x 494 x 8 mm	Work size
			relief, silky-matt	relief, silky-matt	relief, silky-matt	relief, silky-matt	Surface
			64.000	32.000	16.000	8.000	m ² - pieces
			15.360	15.360	16.800	17.040	m ² - kg
			66	33	14	9	Bundle - pieces
			1.031	1.031	0.875	1.125	Bundle - m ²
			15.840	15.840	14.700	19.170	Bundle - kg
			86.625	86.625	70.875	40.500	Pallet - m ²
			1,330.560	1,330.560	1,190.700	690.120	Pallet - kg
			Alb	Alb	Alb	Alb	Product standard
			R11/B	R11/B	R11/B	R11/B	Slip resistance
			2	2	2	2	Stress group
			926i-32100H	926i-34090H	926i-32080H	926i-42580HK	neutral 10
			Price gr. A178 (m ²)	Price gr. A178 (m ²)	Price gr. A178 (m ²)	Price gr. A196 (m ²)	(active white) <input type="checkbox"/> VO
			918i-32100H	918i-34090H	918i-32080H	918i-42580HK	neutral 1
			Price gr. A178 (m ²)	Price gr. A178 (m ²)	Price gr. A178 (m ²)	Price gr. A196 (m ²)	(deep black) <input type="checkbox"/> VO
			<i>555023-32100H^{2/4}</i>	<i>555023-34090H^{2/4}</i>	<i>555023-32080H^{2/4}</i>	<i>555023-42580HK</i>	
			Price gr. A178 (m ²)	Price gr. A178 (m ²)	Price gr. A178 (m ²)	Price gr. A196 (m ²)	medium ochre <input type="checkbox"/> VO
			<i>555035-32100H^{2/4}</i>	<i>555035-34090H^{2/4}</i>	<i>555035-32080H^{2/4}</i>	<i>555035-42580HK</i>	
			Price gr. A178 (m ²)	Price gr. A178 (m ²)	Price gr. A178 (m ²)	Price gr. A196 (m ²)	medium stone grey <input type="checkbox"/> VO
			<i>555036-32100H^{2/4}</i>	<i>555036-34090H^{2/4}</i>	<i>555036-32080H^{2/4}</i>	<i>555036-42580HK</i>	
			Price gr. A178 (m ²)	Price gr. A178 (m ²)	Price gr. A178 (m ²)	Price gr. A196 (m ²)	dark stone grey <input type="checkbox"/> VO
			<i>555038-32100H^{2/4}</i>	<i>555038-34090H^{2/4}</i>	<i>555038-32080H^{2/4}</i>	<i>555038-42580HK</i>	
			Price gr. A178 (m ²)	Price gr. A178 (m ²)	Price gr. A178 (m ²)	Price gr. A196 (m ²)	light sand-grey <input type="checkbox"/> VO
			<i>555039-32100H^{2/4}</i>	<i>555039-34090H^{2/4}</i>	<i>555039-32080H^{2/4}</i>	<i>555039-42580HK</i>	
			Price gr. A178 (m ²)	Price gr. A178 (m ²)	Price gr. A178 (m ²)	Price gr. A196 (m ²)	medium sand-grey <input type="checkbox"/> VO
			<i>555040-32100H^{2/4}</i>	<i>555040-34090H^{2/4}</i>	<i>555040-32080H^{2/4}</i>	<i>555040-42580HK</i>	
			Price gr. A178 (m ²)	Price gr. A178 (m ²)	Price gr. A178 (m ²)	Price gr. A196 (m ²)	dark sand-grey <input type="checkbox"/> VO
			<i>555113-32100H^{2/4}</i>	<i>555113-34090H^{2/4}</i>	<i>555113-32080H^{2/4}</i>	<i>555113-42580HK</i>	
			Price gr. A178 (m ²)	Price gr. A178 (m ²)	Price gr. A178 (m ²)	Price gr. A196 (m ²)	neutral 3
			<i>555117-32100H^{2/4}</i>	<i>555117-34090H^{2/4}</i>	<i>555117-32080H^{2/4}</i>	<i>555117-42580HK</i>	(asphalt black) <input type="checkbox"/> VO
			Price gr. A178 (m ²)	Price gr. A178 (m ²)	Price gr. A178 (m ²)	Price gr. A196 (m ²)	neutral 7
			<i>555118-32100H^{2/4}</i>	<i>555118-34090H^{2/4}</i>	<i>555118-32080H^{2/4}</i>	<i>555118-42580HK</i>	(pebble grey) <input type="checkbox"/> VO
			Price gr. A178 (m ²)	Price gr. A178 (m ²)	Price gr. A178 (m ²)	Price gr. A196 (m ²)	neutral 8
			901i-32100H	901i-34090H	901i-32080H	901i-42580HK	(light-grey) <input type="checkbox"/> VO
			Price gr. A178 (m ²)	Price gr. A178 (m ²)	Price gr. A178 (m ²)	Price gr. A196 (m ²)	natural white <input type="checkbox"/> VO



³ Supplied as double-tiles; to be broken by customer.

⁴ Minimum order quantity: 200 m²

Quantum

Shower Tub System²

12.5 x 25 cm



12.5 x 12.5 cm



12.5 x 12.5 cm



Lip 10 mm Strip

Lip 10 mm Strip

Corner

Model number	27182H	27180H	27181H
Nom. dim. - cm/in	12.5 x 25 / 5 x 10	12.5 x 12.5 / 5 x 5	12.5 x 12.5 / 5 x 5
Work size	119 x 244 x 18/8 mm	119 x 119 x 18/8 mm	119 x 119 x 18/8 mm
Surface	smooth, silky-matt	smooth, silky-matt	smooth, silky-matt
m - pieces	4.000	8,000	
m/pce. - kg	2.720/m	2.720/m	0.500/Stück
Bundle - pieces	22	44	12
Bundle - m	5.500	5.500	
Bundle - kg	14.960	14.960	6.000
Pallet - m			
Pallet - kg			
Product standard	Alb	Alb	Alb
Slip resistance	R10/B	R10/B	R10/B
neutral 10	926i-27182H	926i-27180H	926i-27181H
(active white) <input type="checkbox"/>	Price gr. A506 (pce.)	Price gr. A455 (pce.)	Price gr. A489 (pce.)
neutral 1	918i-27182H	918i-27180H	918i-27181H
(deep black) <input type="checkbox"/>	Price gr. A506 (pce.)	Price gr. A455 (pce.)	Price gr. A489 (pce.)
medium ochre <input type="checkbox"/>	555023-27182H ¹	555023-27180H ¹	555023-27181H ¹
	Price gr. A506 (pce.)	Price gr. A455 (pce.)	Price gr. A489 (pce.)
medium stone grey <input type="checkbox"/>	555035-27182H ¹	555035-27180H ¹	555035-27181H ¹
	Price gr. A506 (pce.)	Price gr. A455 (pce.)	Price gr. A489 (pce.)
dark stone grey <input type="checkbox"/>	555036-27182H ¹	555036-27180H ¹	555036-27181H ¹
	Price gr. A506 (pce.)	Price gr. A455 (pce.)	Price gr. A489 (pce.)
light sand-grey <input type="checkbox"/>	555038-27182H ¹	555038-27180H ¹	555038-27181H ¹
	Price gr. A506 (pce.)	Price gr. A455 (pce.)	Price gr. A489 (pce.)
medium sand-grey <input type="checkbox"/>	555039-27182H ¹	555039-27180H ¹	555039-27181H ¹
	Price gr. A506 (pce.)	Price gr. A455 (pce.)	Price gr. A489 (pce.)
dark sand-grey <input type="checkbox"/>	555040-27182H ¹	555040-27180H ¹	555040-27181H ¹
	Price gr. A506 (pce.)	Price gr. A455 (pce.)	Price gr. A489 (pce.)
neutral 3	555113-27182H ¹	555113-27180H ¹	555113-27181H ¹
(asphalt black) <input type="checkbox"/>	Price gr. A506 (pce.)	Price gr. A455 (pce.)	Price gr. A489 (pce.)
neutral 7	555117-27182H ¹	555117-27180H ¹	555117-27181H ¹
(pebble grey) <input type="checkbox"/>	Price gr. A506 (pce.)	Price gr. A455 (pce.)	Price gr. A489 (pce.)
neutral 8	555118-27182H ¹	555118-27180H ¹	555118-27181H ¹
(light-grey) <input type="checkbox"/>	Price gr. A506 (pce.)	Price gr. A455 (pce.)	Price gr. A489 (pce.)
natural white <input type="checkbox"/>	901i-27182H	901i-27180H	901i-27181H
	Price gr. A506 (pce.)	Price gr. A455 (pce.)	Price gr. A489 (pce.)



² For details, refer to page 295

Quantum

Safety Strip Tile^{1/2}

6.2 x 25 cm



rounded long edge

Skirtings¹

7.9 x 25 cm



Skirting

12.5 x 25 cm³



*Cove skirting,
r = 12 mm*



*External Corner
mitred pair*



*Internal Corner
mitred pair*

<i>rounded long edge</i>	<i>Skirting</i>	<i>Cove skirting, r = 12 mm</i>	<i>External Corner mitred pair</i>	<i>Internal Corner mitred pair</i>	
34306H	34020H	37080	37081	37082	Model number
6,2 x 25 / 2 1/2 x 10	7,9 x 25 / 3 1/8 x 10	12,5 x 25 / 5 x 10			Nom. dim. - cm/in
56 x 244 x 8 mm	73 x 244 x 8 mm	125 x 244/12 x 8 mm	(2x) 131 x 125/12 x 8 mm	(2x) 119 x 125/12 x 8 mm	Work size
gerillt, seidenmatt	eben, seidenmatt	eben, seidenmatt	eben, seidenmatt	eben, seidenmatt	Surface
4,000	4,000	4,000			m - pieces
0,800/m	1,160/m	2,520/m	0,600/Paar	0,400/Paar	m/pair - kg
66 Stück	33 Stück	20 Stück	10 Paar	10 Paar	Bundle - pce./pair
16,500	8,250	5,000			Bundle - m
13,200	9,570	12,600	6,000	4,000	Bundle - kg
					Pallet - m
					Pallet - kg
Alb	Alb	Alb	Alb	Alb	Product standard
-/C					Slip resistance
	926i-34020H	926-37080	926-37081	926-37082	neutral 10
	Price gr. A410 (pce.)	Price gr. A423 (pce.)	Price gr. A455 (pair)	Price gr. A455 (pair)	(active white) <input type="checkbox"/> VO
	918i-34020H	918-37080	918-37081	918-37082	neutral 1
	Price gr. A410 (pce.)	Price gr. A423 (pce.)	Price gr. A455 (pair)	Price gr. A455 (pair)	(deep black) <input type="checkbox"/> VO
	901i-34020H	901-37080	901-37081	901-37082	natural white <input type="checkbox"/> VO
	Price gr. A410 (pce.)	Price gr. A423 (pce.)	Price gr. A455 (pair)	Price gr. A455 (pair)	



² Especially suitable for non-slip and clearly visible (stair) edge design.

³ The cove skirtings comply with DIN EN 14411, group Al_b, glazed (GL)







Colorful and flexible

The color range specially developed for Plural comprises 50 colors matched to one another. Whether glazed or unglazed, earthenware, stoneware or porcelain stoneware – the narrow 3 mm joint is just as standard with Plural as the pollutant-reducing Hytect coating and the design in various slip-resistance classes. Thus, Plural can be used in many indoor and outdoor areas: from the facade to the floor, from the underground station to the wellness landscape.

Meerbad Meerbusch, Meerbusch, Germany / Architect: Planteam Ruhr, Gelsenkirchen, Germany / Series: Pool edge system Wiesbaden
Plural stoneware, Plural non-slip / Photo: Jochen Stüber

COLOR SYSTEM UNICOLOR – A color sphere becomes a sphere of possibilities



Contrasting colors



active ochre NCS S 3050-Y40R	active salmon NCS S 4040-Y70R	active oxid red NCS S 4050-Y90R	active stone grey NCS S 5030-Y90R	active sand grey NCS S 7010-Y90R
light ochre NCS S 2030-Y20R	light salmon NCS S 1515-Y50R	light oxid red NCS S 2010-Y80R	light stone grey NCS S 2502-R	light sand grey NCS S 1502-Y
medium ochre NCS S 3030-Y30R	medium salmon NCS S 2020-Y50R	medium oxid red NCS S 3020-Y80R	medium stone grey NCS S 3502-R or RAL 7036	medium sand grey NCS S 3005-Y50R
dark ochre NCS S 4030-Y50R	dark salmon NCS S 3040-Y60R	dark oxid red NCS S 5020-Y80R	dark stone grey NCS S 6005-Y80R	dark sand grey NCS S 6010-Y50R
ochre	salmon	oxid red	stone grey	sand grey
neutral 5 (basalt-grey) NCS S 5502-B or RAL 7046	neutral 4 (graphite-black) NCS S 6000-N or RAL 7037	neutral 3 (asphalt black) NCS S 6500-N	neutral 2 (anthracite) NCS S 7500-N or RAL 7015	neutral 1 (deep black) NCS S 9000-N or RAL 9017



1120/1121
neutral 10 (active white)



1119
neutral 9 (white-grey)



1118
neutral 8 (light-grey)



1117
neutral 7 (pebble-grey)



1116
neutral 6 (pearl grey)



1115
neutral 5 (basalt-grey)



1114
neutral 4 (graphite-black)



1113
neutral 3 (asphalt black)



1112
neutral 2 (anthracite)



1111
neutral 1 (deep black)



1004
dark azure



1003
medium azure



1002
light azure



1001
active azure



1008
dark blue



1007
medium blue

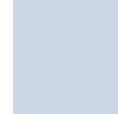

1006
light blue



1005
active blue



1012
dark turquoise



1011
medium turquoise



1010
light turquoise



1009
active turquoise



1016
dark green



1015
medium green



1014
light green



1013
active green



1020
dark yellow



1019
medium yellow



1018
light yellow



1017
active yellow



1024
dark ochre



1023
medium ochre



1022
light ochre



1021
active ochre



1028
dark salmon



1027
medium salmon



1026
light salmon



1025
active salmon



1032
dark oxide red



1031
medium oxide red



1030
light oxide red



1029
active oxide red



1036
dark stone grey



1035
medium stone grey



1034
light stone grey



1033
active stone grey



1040
dark sand grey



1039
medium sand grey



1038
light sand grey



1037
active sand grey

Formats – Earthenware



Wall tile 10 x 20 cm
4 x 8 in, smooth

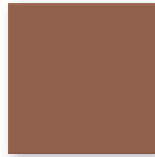

Wall tile 15 x 15 cm
6 x 6 in, smooth



Wall tile 20 x 20 cm
8 x 8 in, smooth



Wall tile 30 x 60 cm
12 x 24 in, smooth



Wall tile 10 x 30 cm
4 x 12 in, smooth



Wall tile 15 x 30 cm
6 x 12 in, smooth



Wall tile 20 x 40 cm
8 x 16 in, smooth



Wall tile 10 x 40 cm
4 x 16 in, smooth



Wall tile 10 x 60 cm
4 x 24 in, smooth

Wall Tiles

10 x 20 cm



10 x 30 cm



10 x 40 cm



10 x 60 cm



15 x 15 cm^{2/3}



15 x 15 cm²



15 x 30 cm²



Nom. dim. - cm/in	10 x 20 / 4 x 8	10 x 30 / 4 x 12	10 x 40 / 4 x 16	10 x 60 / 4 x 24	15 x 15 / 6 x 6	15 x 15 / 6 x 6	15 x 30 / 6 x 12
Work size	97 x 197 x 6.5 mm	97 x 297 x 9 mm	97 x 397 x 7.5 mm	97 x 597 x 9 mm	147 x 147 x 6.5 mm	147 x 147 x 6.5 mm	147 x 297 x 6.5 mm
Surface	silky-matt, for op-theat.	silky-matt, for op-theat.	silky-matt, for op-theat.	silky-matt, for op-theat.	glossy	glossy	silky-matt, for op-theat.
m ² - pieces	50.000	33.333	25.000	16.667	44.000	44.000	22.222
m ² - kg	11.050	14.100	13.375	14.084	10.780	10.780	10.622
Bundle - pieces	33	16	12	16	44	44	24
Bundle - m ²	0.660	0.480	0.480	0.960	1.000	1.000	1.080
Bundle - kg	7.293	6.768	6.420	13.520	10.780	10.780	11.472
Pallet - m ²	59.400	65.281	46.080	38.399	100.000	100.000	91.801
Pallet - kg	656.370	920.448	616.320	540.800	1,078.000	1,078.000	975.120
Product standard	BIII	BIII	BIII	BIII	BIII	BIII	BIII
neutral 10 (active)	120-1121H³	113-1121H³	140-1121H³	160-1121H³	115-1121H³		130-1121H³
white glossy	Price gr. A157 (m ²)	Price gr. A121 (m ²)	Price gr. A121 (m ²)	Price gr. A154 (m ²)	Price gr. A70 (m ²)		Price gr. A100 (m ²)
neutral 10	120-1120H	113-1120H	140-1120H	160-1120H		116-1120H	130-1120H
(active white)	Price gr. A157 (m ²)	Price gr. A121 (m ²)	Price gr. A121 (m ²)	Price gr. A154 (m ²)		Price gr. A70 (m ²)	Price gr. A100 (m ²)
neutral 9	120-1119H	113-1119H¹	140-1119H	160-1119H	115-1119H	116-1119H	130-1119H
(white-grey)	Price gr. A178 (m ²)	Price gr. A169 (m ²)	Price gr. A148 (m ²)	Price gr. A169 (m ²)	Price gr. A94 (m ²)	Price gr. A94 (m ²)	Price gr. A121 (m ²)
neutral 8	120-1118H¹	113-1118H¹	140-1118H¹	160-1118H¹	115-1118H¹	116-1118H	130-1118H¹
(light-grey)	Price gr. A211 (m ²)	Price gr. A169 (m ²)	Price gr. A169 (m ²)	Price gr. A199 (m ²)	Price gr. A121 (m ²)	Price gr. A70 (m ²)	Price gr. A148 (m ²)
neutral 7	120-1117H	113-1117H¹	140-1117H	160-1117H	115-1117H	116-1117H	130-1117H
(pebble grey)	Price gr. A178 (m ²)	Price gr. A169 (m ²)	Price gr. A148 (m ²)	Price gr. A169 (m ²)	Price gr. A94 (m ²)	Price gr. A94 (m ²)	Price gr. A121 (m ²)
neutral 6	120-1116H¹	113-1116H¹	140-1116H¹	160-1116H¹	115-1116H¹	116-1116H	130-1116H¹
(pearl grey)	Price gr. A211 (m ²)	Price gr. A169 (m ²)	Price gr. A169 (m ²)	Price gr. A199 (m ²)	Price gr. A121 (m ²)	Price gr. A94 (m ²)	Price gr. A148 (m ²)
neutral 5	120-1115H	113-1115H¹	140-1115H	160-1115H	115-1115H	116-1115H	130-1115H
(basalt grey)	Price gr. A178 (m ²)	Price gr. A169 (m ²)	Price gr. A148 (m ²)	Price gr. A169 (m ²)	Price gr. A94 (m ²)	Price gr. A94 (m ²)	Price gr. A121 (m ²)
neutral 4	120-1114H¹	113-1114H¹	140-1114H¹	160-1114H¹	115-1114H¹	116-1114H	130-1114H¹
(graphite black)	Price gr. A211 (m ²)	Price gr. A169 (m ²)	Price gr. A169 (m ²)	Price gr. A199 (m ²)	Price gr. A121 (m ²)	Price gr. A94 (m ²)	Price gr. A148 (m ²)
neutral 3	120-1113H	113-1113H¹	140-1113H	160-1113H	115-1113H	116-1113H	130-1113H
(asphalt black)	Price gr. A178 (m ²)	Price gr. A169 (m ²)	Price gr. A148 (m ²)	Price gr. A169 (m ²)	Price gr. A94 (m ²)	Price gr. A94 (m ²)	Price gr. A121 (m ²)
neutral 2	120-1112H¹	113-1112H¹	140-1112H¹	160-1112H¹	115-1112H¹	116-1112H	130-1112H¹
(anthracite)	Price gr. A211 (m ²)	Price gr. A169 (m ²)	Price gr. A169 (m ²)	Price gr. A199 (m ²)	Price gr. A121 (m ²)	Price gr. A94 (m ²)	Price gr. A121 (m ²)
neutral 1	120-1111H	113-1111H¹	140-1111H	160-1111H	115-1111H	116-1111H	130-1111H
(deep black)	Price gr. A178 (m ²)	Price gr. A169 (m ²)	Price gr. A148 (m ²)	Price gr. A169 (m ²)	Price gr. A94 (m ²)	Price gr. A94 (m ²)	Price gr. A121 (m ²)
active azure	120-1001H¹	113-1001H¹	140-1001H¹	160-1001H¹	115-1001H¹	116-1001H¹	130-1001H¹
	Price gr. A211 (m ²)	Price gr. A169 (m ²)	Price gr. A169 (m ²)	Price gr. A199 (m ²)	Price gr. A121 (m ²)	Price gr. A121 (m ²)	Price gr. A148 (m ²)
light azure	120-1002H¹	113-1002H¹	140-1002H¹	160-1002H¹	115-1002H¹	116-1002H	130-1002H¹
	Price gr. A211 (m ²)	Price gr. A169 (m ²)	Price gr. A169 (m ²)	Price gr. A199 (m ²)	Price gr. A121 (m ²)	Price gr. A94 (m ²)	Price gr. A148 (m ²)
medium azure	120-1003H¹	113-1003H¹	140-1003H¹	160-1003H¹	115-1003H¹	116-1003H¹	130-1003H¹
	Price gr. A211 (m ²)	Price gr. A169 (m ²)	Price gr. A169 (m ²)	Price gr. A199 (m ²)	Price gr. A121 (m ²)	Price gr. A121 (m ²)	Price gr. A148 (m ²)
dark azure	120-1004H	113-1004H¹	140-1004H	160-1004H	115-1004H	116-1004H	130-1004H
	Price gr. A178 (m ²)	Price gr. A169 (m ²)	Price gr. A148 (m ²)	Price gr. A169 (m ²)	Price gr. A94 (m ²)	Price gr. A94 (m ²)	Price gr. A121 (m ²)
active blue	120-1005H¹	113-1005H¹	140-1005H¹	160-1005H¹	115-1005H¹	116-1005H¹	130-1005H¹
	Price gr. A211 (m ²)	Price gr. A169 (m ²)	Price gr. A148 (m ²)	Price gr. A199 (m ²)	Price gr. A121 (m ²)	Price gr. A121 (m ²)	Price gr. A148 (m ²)
light blue	120-1006H¹	113-1006H¹	140-1006H¹	160-1006H¹	115-1006H¹	116-1006H	130-1006H¹
	Price gr. A211 (m ²)	Price gr. A169 (m ²)	Price gr. A169 (m ²)	Price gr. A199 (m ²)	Price gr. A121 (m ²)	Price gr. A94 (m ²)	Price gr. A148 (m ²)
medium blue	120-1007H¹	113-1007H¹	140-1007H¹	160-1007H¹	115-1007H¹	116-1007H¹	130-1007H¹
	Price gr. A211 (m ²)	Price gr. A169 (m ²)	Price gr. A169 (m ²)	Price gr. A199 (m ²)	Price gr. A121 (m ²)	Price gr. A121 (m ²)	Price gr. A148 (m ²)
dark blue	120-1008H	113-1008H¹	140-1008H	160-1008H	115-1008H	116-1008H	130-1008H
	Price gr. A178 (m ²)	Price gr. A169 (m ²)	Price gr. A148 (m ²)	Price gr. A169 (m ²)	Price gr. A94 (m ²)	Price gr. A94 (m ²)	Price gr. A121 (m ²)
active turquoise	120-1009H¹	113-1009H¹	140-1009H¹	160-1009H¹	115-1009H¹	116-1009H¹	130-1009H¹
	Price gr. A211 (m ²)	Price gr. A169 (m ²)	Price gr. A169 (m ²)	Price gr. A199 (m ²)	Price gr. A121 (m ²)	Price gr. A121 (m ²)	Price gr. A148 (m ²)
light turquoise	120-1010H¹	113-1010H¹	140-1010H¹	160-1010H¹	115-1010H¹	116-1010H¹	130-1010H¹
	Price gr. A211 (m ²)	Price gr. A169 (m ²)	Price gr. A169 (m ²)	Price gr. A199 (m ²)	Price gr. A121 (m ²)	Price gr. A94 (m ²)	Price gr. A148 (m ²)
medium turquoise	120-1011H¹	113-1011H¹	140-1011H¹	160-1011H¹	115-1011H¹	116-1011H¹	130-1011H¹
	Price gr. A211 (m ²)	Price gr. A169 (m ²)	Price gr. A169 (m ²)	Price gr. A199 (m ²)	Price gr. A121 (m ²)	Price gr. A121 (m ²)	Price gr. A148 (m ²)
dark turquoise	120-1012H	113-1012H¹	140-1012H	160-1012H	115-1012H	116-1012H	130-1012H
	Price gr. A178 (m ²)	Price gr. A169 (m ²)	Price gr. A148 (m ²)	Price gr. A169 (m ²)	Price gr. A94 (m ²)	Price gr. A94 (m ²)	Price gr. A121 (m ²)
active green	120-1013H¹	113-1013H¹	140-1013H¹	160-1013H¹	115-1013H¹	116-1013H¹	130-1013H¹
	Price gr. A211 (m ²)	Price gr. A169 (m ²)	Price gr. A169 (m ²)	Price gr. A199 (m ²)	Price gr. A121 (m ²)	Price gr. A121 (m ²)	Price gr. A148 (m ²)
light green	120-1014H¹	113-1014H¹	140-1014H¹	160-1014H¹	115-1014H¹	116-1014H	130-1014H¹
	Price gr. A211 (m ²)	Price gr. A169 (m ²)	Price gr. A169 (m ²)	Price gr. A199 (m ²)	Price gr. A121 (m ²)	Price gr. A94 (m ²)	Price gr. A148 (m ²)
medium green	120-1015H¹	113-1015H¹	140-1015H¹	160-1015H¹	115-1015H¹	116-1015H¹	130-1015H¹
	Price gr. A211 (m ²)	Price gr. A169 (m ²)	Price gr. A169 (m ²)	Price gr. A199 (m ²)	Price gr. A121 (m ²)	Price gr. A121 (m ²)	Price gr. A148 (m ²)
dark green	120-1016H	113-1016H¹	140-1016H	160-1016H	115-1016H	116-1016H	130-1016H
	Price gr. A178 (m ²)	Price gr. A169 (m ²)	Price gr. A148 (m ²)	Price gr. A169 (m ²)	Price gr. A94 (m ²)	Price gr. A94 (m ²)	Price gr. A121 (m ²)



² One overglazed head edge 10% per delivery. Edges overglazed 2/3 each.

³ Not suitable for operating theatres.

Wall Tiles

20 x 20 cm²



20 x 40 cm²



30 x 60 cm

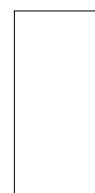

				20 x 20 / 8 x 8	20 x 40 / 8 x 16	30 x 60 / 12 x 24	Nom. dim. - cm/in
				197 x 197 x 6.5 mm	197 x 397 x 7.5 mm	297 x 597 x 9 mm	Work size
				silky-matt, for op-theat.	silky-matt, for op-theat.	silky-matt, for op-theat.	Surface
				25.000	12.500	5.556	m ² - pieces
				10.900	12.975	14.946	m ² - kg
				25	16	9	Bundle - pieces
				1.000	1.280	1.620	Bundle - m ²
				10.900	16.608	24.210	Bundle - kg
				96.000	92.160	77.754	Pallet - m ²
				1,046.400	1,195.776	1,162.080	Pallet - kg
				BIII	BIII	BIII	Product standard
				220-1121H³	240-1121H³	360-1121H³	neutral 10 (active
				Price gr. A70 (m ²)	Price gr. A100 (m ²)	Price gr. A88 (m ²)	white glossy) <input type="checkbox"/>
				220-1120H	240-1120H	360-1120H	neutral 10
				Price gr. A70 (m ²)	Price gr. A100 (m ²)	Price gr. A88 (m ²)	(active white) <input type="checkbox"/>
				220-1119H	240-1119H	360-1119H	neutral 9
				Price gr. A94 (m ²)	Price gr. A121 (m ²)	Price gr. A109 (m ²)	(white-grey) <input type="checkbox"/>
				220-1118H	240-1118H¹	360-1118H	neutral 8
				Price gr. A70 (m ²)	Price gr. A148 (m ²)	Price gr. A109 (m ²)	(light-grey) <input type="checkbox"/>
				220-1117H	240-1117H	360-1117H	neutral 7
				Price gr. A94 (m ²)	Price gr. A121 (m ²)	Price gr. A109 (m ²)	(pebble grey) <input type="checkbox"/>
				220-1116H	240-1116H¹	360-1116H¹	neutral 6
				Price gr. A94 (m ²)	Price gr. A148 (m ²)	Price gr. A136 (m ²)	(pearl grey) <input type="checkbox"/>
				220-1115H	240-1115H	360-1115H	neutral 5
				Price gr. A94 (m ²)	Price gr. A121 (m ²)	Price gr. A109 (m ²)	(basalt grey) <input type="checkbox"/>
				220-1114H	240-1114H¹	360-1114H¹	neutral 4
				Price gr. A94 (m ²)	Price gr. A148 (m ²)	Price gr. A136 (m ²)	(graphite black) <input type="checkbox"/>
				220-1113H	240-1113H	360-1113H	neutral 3
				Price gr. A94 (m ²)	Price gr. A121 (m ²)	Price gr. A109 (m ²)	(asphalt black) <input type="checkbox"/>
				220-1112H	240-1112H¹	360-1112H¹	neutral 2
				Price gr. A94 (m ²)	Price gr. A148 (m ²)	Price gr. A136 (m ²)	(anthracite) <input type="checkbox"/>
				220-1111H	240-1111H	360-1111H	neutral 1
				Price gr. A94 (m ²)	Price gr. A121 (m ²)	Price gr. A109 (m ²)	(deep black) <input type="checkbox"/>
				220-1001H¹	240-1001H¹	360-1001H¹	active azure <input type="checkbox"/>
				Price gr. A121 (m ²)	Price gr. A148 (m ²)	Price gr. A136 (m ²)	
				220-1002H	240-1002H	360-1002H¹	light azure <input type="checkbox"/>
				Price gr. A94 (m ²)	Price gr. A121 (m ²)	Price gr. A136 (m ²)	
				220-1003H¹	240-1003H¹	360-1003H¹	medium azure <input type="checkbox"/>
				Price gr. A121 (m ²)	Price gr. A148 (m ²)	Price gr. A136 (m ²)	
				220-1004H	240-1004H	360-1004H	dark azure <input type="checkbox"/>
				Price gr. A94 (m ²)	Price gr. A121 (m ²)	Price gr. A109 (m ²)	
				220-1005H¹	240-1005H¹	360-1005H¹	active blue <input type="checkbox"/>
				Price gr. A121 (m ²)	Price gr. A148 (m ²)	Price gr. A136 (m ²)	
				220-1006H	240-1006H	360-1006H¹	light blue <input type="checkbox"/>
				Price gr. A94 (m ²)	Price gr. A121 (m ²)	Price gr. A136 (m ²)	
				220-1007H¹	240-1007H¹	360-1007H¹	medium blue <input type="checkbox"/>
				Price gr. A121 (m ²)	Price gr. A148 (m ²)	Price gr. A136 (m ²)	
				220-1008H	240-1008H	360-1008H	dark blue <input type="checkbox"/>
				Price gr. A94 (m ²)	Price gr. A121 (m ²)	Price gr. A109 (m ²)	
				220-1009H¹	240-1009H¹	360-1009H¹	active turquoise <input type="checkbox"/>
				Price gr. A121 (m ²)	Price gr. A148 (m ²)	Price gr. A136 (m ²)	
				220-1010H	240-1010H	360-1010H¹	light turquoise <input type="checkbox"/>
				Price gr. A94 (m ²)	Price gr. A121 (m ²)	Price gr. A136 (m ²)	
				220-1011H¹	240-1011H¹	360-1011H¹	medium turquoise <input type="checkbox"/>
				Price gr. A121 (m ²)	Price gr. A148 (m ²)	Price gr. A136 (m ²)	
				220-1012H	240-1012H	360-1012H	dark turquoise <input type="checkbox"/>
				Price gr. A94 (m ²)	Price gr. A121 (m ²)	Price gr. A109 (m ²)	
				220-1013H¹	240-1013H¹	360-1013H¹	active green <input type="checkbox"/>
				Price gr. A121 (m ²)	Price gr. A148 (m ²)	Price gr. A136 (m ²)	
				220-1014H	240-1014H	360-1014H¹	light green <input type="checkbox"/>
				Price gr. A94 (m ²)	Price gr. A121 (m ²)	Price gr. A136 (m ²)	
				220-1015H¹	240-1015H¹	360-1015H¹	medium green <input type="checkbox"/>
				Price gr. A121 (m ²)	Price gr. A148 (m ²)	Price gr. A136 (m ²)	
				220-1016H	240-1016H	360-1016H	dark green <input type="checkbox"/>
				Price gr. A94 (m ²)	Price gr. A121 (m ²)	Price gr. A109 (m ²)	



¹ One overglazed head edge 10% per delivery. Edges overglazed 2/3 each.
³ Not suitable for operating theatres.

Wall Tiles

10 x 20 cm



10 x 30 cm



10 x 40 cm



10 x 60 cm



15 x 15 cm^{2/3}



15 x 15 cm²



15 x 30 cm²



Nom. dim. - cm/in	10 x 20 / 4 x 8	10 x 30 / 4 x 12	10 x 40 / 4 x 16	10 x 60 / 4 x 24	15 x 15 / 6 x 6	15 x 15 / 6 x 6	15 x 30 / 6 x 12
Work size	97 x 197 x 6.5 mm	97 x 297 x 9 mm	97 x 397 x 7.5 mm	97 x 597 x 9 mm	147 x 147 x 6.5 mm	147 x 147 x 6.5 mm	147 x 297 x 6.5 mm
Surface	silky-matt, for op-theat.	silky-matt, for op-theat.	silky-matt, for op-theat.	silky-matt, for op-theat.	glossy	glossy	silky-matt, for op-theat.
m ² - pieces	50.000	33.333	25.000	16.667	44.000	44.000	22.222
m ² - kg	11.050	14.100	13.375	14.084	10.780	10.780	10.622
Bundle - pieces	33	16	12	16	44	44	24
Bundle - m ²	0.660	0.480	0.480	0.960	1.000	1.000	1.080
Bundle - kg	7.293	6.768	6.420	13.520	10.780	10.780	11.472
Pallet - m ²	59.400	65.281	46.080	38.399	100.000	100.000	91.801
Pallet - kg	656.370	920.448	616.320	540.800	1,078.000	1,078.000	975.120
Product standard	BIII	BIII	BIII	BIII	BIII	BIII	BIII
active yellow	120-1017H ¹ Price gr. A211 (m ²)	113-1017H ¹ Price gr. A169 (m ²)	140-1017H ¹ Price gr. A169 (m ²)	160-1017H ¹ Price gr. A199 (m ²)	115-1017H ¹ Price gr. A121 (m ²)	116-1017H ¹ Price gr. A121 (m ²)	130-1017H ¹ Price gr. A148 (m ²)
light yellow	120-1018H ¹ Price gr. A211 (m ²)	113-1018H ¹ Price gr. A169 (m ²)	140-1018H ¹ Price gr. A169 (m ²)	160-1018H ¹ Price gr. A199 (m ²)	115-1018H ¹ Price gr. A121 (m ²)	116-1018H ¹ Price gr. A94 (m ²)	130-1018H ¹ Price gr. A148 (m ²)
medium yellow	120-1019H ¹ Price gr. A211 (m ²)	113-1019H ¹ Price gr. A169 (m ²)	140-1019H ¹ Price gr. A169 (m ²)	160-1019H ¹ Price gr. A199 (m ²)	115-1019H ¹ Price gr. A121 (m ²)	116-1019H ¹ Price gr. A121 (m ²)	130-1019H ¹ Price gr. A148 (m ²)
dark yellow	120-1020H ¹ Price gr. A178 (m ²)	113-1020H ¹ Price gr. A169 (m ²)	140-1020H ¹ Price gr. A148 (m ²)	160-1020H ¹ Price gr. A169 (m ²)	115-1020H ¹ Price gr. A94 (m ²)	116-1020H ¹ Price gr. A94 (m ²)	130-1020H ¹ Price gr. A121 (m ²)
active ochre	120-1021H ¹ Price gr. A211 (m ²)	113-1021H ¹ Price gr. A169 (m ²)	140-1021H ¹ Price gr. A169 (m ²)	160-1021H ¹ Price gr. A199 (m ²)	115-1021H ¹ Price gr. A121 (m ²)	116-1021H ¹ Price gr. A121 (m ²)	130-1021H ¹ Price gr. A148 (m ²)
light ochre	120-1022H ¹ Price gr. A211 (m ²)	113-1022H ¹ Price gr. A169 (m ²)	140-1022H ¹ Price gr. A169 (m ²)	160-1022H ¹ Price gr. A199 (m ²)	115-1022H ¹ Price gr. A121 (m ²)	116-1022H ¹ Price gr. A94 (m ²)	130-1022H ¹ Price gr. A148 (m ²)
medium ochre	120-1023H ¹ Price gr. A211 (m ²)	113-1023H ¹ Price gr. A169 (m ²)	140-1023H ¹ Price gr. A169 (m ²)	160-1023H ¹ Price gr. A199 (m ²)	115-1023H ¹ Price gr. A121 (m ²)	116-1023H ¹ Price gr. A121 (m ²)	130-1023H ¹ Price gr. A148 (m ²)
dark ochre	120-1024H ¹ Price gr. A178 (m ²)	113-1024H ¹ Price gr. A169 (m ²)	140-1024H ¹ Price gr. A148 (m ²)	160-1024H ¹ Price gr. A169 (m ²)	115-1024H ¹ Price gr. A94 (m ²)	116-1024H ¹ Price gr. A94 (m ²)	130-1024H ¹ Price gr. A121 (m ²)
active salmon	120-1025H ¹ Price gr. A211 (m ²)	113-1025H ¹ Price gr. A169 (m ²)	140-1025H ¹ Price gr. A169 (m ²)	160-1025H ¹ Price gr. A199 (m ²)	115-1025H ¹ Price gr. A121 (m ²)	116-1025H ¹ Price gr. A121 (m ²)	130-1025H ¹ Price gr. A148 (m ²)
light salmon	120-1026H ¹ Price gr. A211 (m ²)	113-1026H ¹ Price gr. A169 (m ²)	140-1026H ¹ Price gr. A169 (m ²)	160-1026H ¹ Price gr. A199 (m ²)	115-1026H ¹ Price gr. A121 (m ²)	116-1026H ¹ Price gr. A94 (m ²)	130-1026H ¹ Price gr. A148 (m ²)
medium salmon	120-1027H ¹ Price gr. A211 (m ²)	113-1027H ¹ Price gr. A169 (m ²)	140-1027H ¹ Price gr. A169 (m ²)	160-1027H ¹ Price gr. A199 (m ²)	115-1027H ¹ Price gr. A121 (m ²)	116-1027H ¹ Price gr. A121 (m ²)	130-1027H ¹ Price gr. A148 (m ²)
dark salmon	120-1028H ¹ Price gr. A178 (m ²)	113-1028H ¹ Price gr. A169 (m ²)	140-1028H ¹ Price gr. A148 (m ²)	160-1028H ¹ Price gr. A169 (m ²)	115-1028H ¹ Price gr. A94 (m ²)	116-1028H ¹ Price gr. A94 (m ²)	130-1028H ¹ Price gr. A121 (m ²)
active oxide red	120-1029H ¹ Price gr. A211 (m ²)	113-1029H ¹ Price gr. A169 (m ²)	140-1029H ¹ Price gr. A169 (m ²)	160-1029H ¹ Price gr. A199 (m ²)	115-1029H ¹ Price gr. A121 (m ²)	116-1029H ¹ Price gr. A121 (m ²)	130-1029H ¹ Price gr. A148 (m ²)
light oxide red	120-1030H ¹ Price gr. A211 (m ²)	113-1030H ¹ Price gr. A169 (m ²)	140-1030H ¹ Price gr. A169 (m ²)	160-1030H ¹ Price gr. A199 (m ²)	115-1030H ¹ Price gr. A121 (m ²)	116-1030H ¹ Price gr. A94 (m ²)	130-1030H ¹ Price gr. A148 (m ²)
medium oxide red	120-1031H ¹ Price gr. A211 (m ²)	113-1031H ¹ Price gr. A169 (m ²)	140-1031H ¹ Price gr. A169 (m ²)	160-1031H ¹ Price gr. A199 (m ²)	115-1031H ¹ Price gr. A121 (m ²)	116-1031H ¹ Price gr. A121 (m ²)	130-1031H ¹ Price gr. A148 (m ²)
dark oxide red	120-1032H ¹ Price gr. A178 (m ²)	113-1032H ¹ Price gr. A169 (m ²)	140-1032H ¹ Price gr. A148 (m ²)	160-1032H ¹ Price gr. A169 (m ²)	115-1032H ¹ Price gr. A94 (m ²)	116-1032H ¹ Price gr. A94 (m ²)	130-1032H ¹ Price gr. A121 (m ²)
active stone grey	120-1033H ¹ Price gr. A211 (m ²)	113-1033H ¹ Price gr. A169 (m ²)	140-1033H ¹ Price gr. A169 (m ²)	160-1033H ¹ Price gr. A199 (m ²)	115-1033H ¹ Price gr. A121 (m ²)	116-1033H ¹ Price gr. A121 (m ²)	130-1033H ¹ Price gr. A148 (m ²)
light stone grey	120-1034H ¹ Price gr. A211 (m ²)	113-1034H ¹ Price gr. A169 (m ²)	140-1034H ¹ Price gr. A169 (m ²)	160-1034H ¹ Price gr. A199 (m ²)	115-1034H ¹ Price gr. A121 (m ²)	116-1034H ¹ Price gr. A94 (m ²)	130-1034H ¹ Price gr. A148 (m ²)
medium stone grey	120-1035H ¹ Price gr. A211 (m ²)	113-1035H ¹ Price gr. A169 (m ²)	140-1035H ¹ Price gr. A169 (m ²)	160-1035H ¹ Price gr. A199 (m ²)	115-1035H ¹ Price gr. A121 (m ²)	116-1035H ¹ Price gr. A121 (m ²)	130-1035H ¹ Price gr. A148 (m ²)
dark stone grey	120-1036H ¹ Price gr. A178 (m ²)	113-1036H ¹ Price gr. A169 (m ²)	140-1036H ¹ Price gr. A148 (m ²)	160-1036H ¹ Price gr. A169 (m ²)	115-1036H ¹ Price gr. A94 (m ²)	116-1036H ¹ Price gr. A94 (m ²)	130-1036H ¹ Price gr. A121 (m ²)
active sand-grey	120-1037H ¹ Price gr. A211 (m ²)	113-1037H ¹ Price gr. A169 (m ²)	140-1037H ¹ Price gr. A169 (m ²)	160-1037H ¹ Price gr. A199 (m ²)	115-1037H ¹ Price gr. A121 (m ²)	116-1037H ¹ Price gr. A121 (m ²)	130-1037H ¹ Price gr. A148 (m ²)
light sand-grey	120-1038H ¹ Price gr. A211 (m ²)	113-1038H ¹ Price gr. A148 (m ²)	140-1038H ¹ Price gr. A148 (m ²)	160-1038H ¹ Price gr. A199 (m ²)	115-1038H ¹ Price gr. A94 (m ²)	116-1038H ¹ Price gr. A94 (m ²)	130-1038H ¹ Price gr. A121 (m ²)
medium sand-grey	120-1039H ¹ Price gr. A211 (m ²)	113-1039H ¹ Price gr. A169 (m ²)	140-1039H ¹ Price gr. A169 (m ²)	160-1039H ¹ Price gr. A199 (m ²)	115-1039H ¹ Price gr. A121 (m ²)	116-1039H ¹ Price gr. A121 (m ²)	130-1039H ¹ Price gr. A121 (m ²)
dark sand-grey	120-1040H ¹ Price gr. A178 (m ²)	113-1040H ¹ Price gr. A169 (m ²)	140-1040H ¹ Price gr. A148 (m ²)	160-1040H ¹ Price gr. A169 (m ²)	115-1040H ¹ Price gr. A94 (m ²)	116-1040H ¹ Price gr. A94 (m ²)	130-1040H ¹ Price gr. A121 (m ²)



² One overglazed head edge 10 % per delivery. Edges overglazed 2/3 each.

³ Not suitable for operating theatres.

Wall Tiles

20 x 20 cm²



20 x 40 cm²



30 x 60 cm

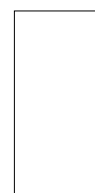

				20 x 20 / 8 x 8	20 x 40 / 8 x 16	30 x 60 / 12 x 24	Nom. dim. - cm/in
				197 x 197 x 6.5 mm	197 x 397 x 7.5 mm	297 x 597 x 9 mm	Work size
				silky-matt, for op-theat.	silky-matt, for op-theat.	silky-matt, for op-theat.	Surface
				25.000	12.500	5.556	m ² - pieces
				10.900	12.975	14.946	m ² - kg
				25	16	9	Bundle - pieces
				1.000	1.280	1.620	Bundle - m ²
				10.900	16.608	24.210	Bundle - kg
				96.000	92.160	77.754	Pallet - m ²
				1,046.400	1,195.776	1,162.080	Pallet - kg
				Bill	Bill	Bill	Product standard
				220-1017H ¹	240-1017H ¹	360-1017H ¹	active yellow <input type="checkbox"/>
				Price gr. A121 (m ²)	Price gr. A148 (m ²)	Price gr. A136 (m ²)	
				220-1018H	240-1018H	360-1018H ¹	light yellow <input type="checkbox"/>
				Price gr. A94 (m ²)	Price gr. A121 (m ²)	Price gr. A136 (m ²)	
				220-1019H ¹	240-1019H ¹	360-1019H ¹	medium yellow <input type="checkbox"/>
				Price gr. A121 (m ²)	Price gr. A148 (m ²)	Price gr. A136 (m ²)	
				220-1020H	240-1020H	360-1020H	dark yellow <input type="checkbox"/>
				Price gr. A94 (m ²)	Price gr. A121 (m ²)	Price gr. A109 (m ²)	
				220-1021H ¹	240-1021H ¹	360-1021H ¹	active ochre <input type="checkbox"/>
				Price gr. A121 (m ²)	Price gr. A148 (m ²)	Price gr. A136 (m ²)	
				220-1022H	240-1022H	360-1022H ¹	light ochre <input type="checkbox"/>
				Price gr. A94 (m ²)	Price gr. A121 (m ²)	Price gr. A136 (m ²)	
				220-1023H ¹	240-1023H ¹	360-1023H ¹	medium ochre <input type="checkbox"/>
				Price gr. A121 (m ²)	Price gr. A148 (m ²)	Price gr. A136 (m ²)	
				220-1024H	240-1024H	360-1024H	dark ochre <input type="checkbox"/>
				Price gr. A94 (m ²)	Price gr. A121 (m ²)	Price gr. A109 (m ²)	
				220-1025H ¹	240-1025H ¹	360-1025H ¹	active salmon <input type="checkbox"/>
				Price gr. A121 (m ²)	Price gr. A148 (m ²)	Price gr. A136 (m ²)	
				220-1026H	240-1026H	360-1026H ¹	light salmon <input type="checkbox"/>
				Price gr. A94 (m ²)	Price gr. A121 (m ²)	Price gr. A136 (m ²)	
				220-1027H ¹	240-1027H ¹	360-1027H ¹	medium salmon <input type="checkbox"/>
				Price gr. A121 (m ²)	Price gr. A148 (m ²)	Price gr. A136 (m ²)	
				220-1028H	240-1028H	360-1028H	dark salmon <input type="checkbox"/>
				Price gr. A94 (m ²)	Price gr. A121 (m ²)	Price gr. A109 (m ²)	
				220-1029H ¹	240-1029H ¹	360-1029H ¹	active oxide red <input type="checkbox"/>
				Price gr. A121 (m ²)	Price gr. A148 (m ²)	Price gr. A136 (m ²)	
				220-1030H	240-1030H	360-1030H ¹	light oxide red <input type="checkbox"/>
				Price gr. A94 (m ²)	Price gr. A121 (m ²)	Price gr. A136 (m ²)	
				220-1031H ¹	240-1031H ¹	360-1031H ¹	medium oxide red <input type="checkbox"/>
				Price gr. A121 (m ²)	Price gr. A148 (m ²)	Price gr. A136 (m ²)	
				220-1032H	240-1032H	360-1032H	dark oxide red <input type="checkbox"/>
				Price gr. A94 (m ²)	Price gr. A121 (m ²)	Price gr. A109 (m ²)	
				220-1033H ¹	240-1033H ¹	360-1033H ¹	active stone grey <input type="checkbox"/>
				Price gr. A121 (m ²)	Price gr. A148 (m ²)	Price gr. A136 (m ²)	
				220-1034H	240-1034H	360-1034H ¹	light stone grey <input type="checkbox"/>
				Price gr. A94 (m ²)	Price gr. A121 (m ²)	Price gr. A136 (m ²)	
				220-1035H ¹	240-1035H ¹	360-1035H ¹	medium stone grey <input type="checkbox"/>
				Price gr. A121 (m ²)	Price gr. A148 (m ²)	Price gr. A136 (m ²)	
				220-1036H	240-1036H	360-1036H	dark stone grey <input type="checkbox"/>
				Price gr. A94 (m ²)	Price gr. A121 (m ²)	Price gr. A109 (m ²)	
				220-1037H ¹	240-1037H ¹	360-1037H ¹	active sand-grey <input type="checkbox"/>
				Price gr. A121 (m ²)	Price gr. A148 (m ²)	Price gr. A136 (m ²)	
				220-1038H	240-1038H	360-1038H	light sand-grey <input type="checkbox"/>
				Price gr. A94 (m ²)	Price gr. A121 (m ²)	Price gr. A109 (m ²)	
				220-1039H	240-1039H ¹	360-1039H ¹	medium sand-grey <input type="checkbox"/>
				Price gr. A94 (m ²)	Price gr. A148 (m ²)	Price gr. A136 (m ²)	
				220-1040H	240-1040H	360-1040H	dark sand-grey <input type="checkbox"/>
				Price gr. A94 (m ²)	Price gr. A121 (m ²)	Price gr. A109 (m ²)	



² One overglazed head edge 10% per delivery. Edges overglazed 2/3 each.

³ Not suitable for operating theatres.

Plural
Contrasting colors



2120/2121/700/701
neutral 10 (active white)



2119/552119
neutral 9 (white-grey)



2118/552118
neutral 8 (light-grey)



2117/552117
neutral 7 (pebble-grey)



2116/552116
neutral 6 (pearl grey)



2115/552115
neutral 5 (basalt-grey)



2114/552114
neutral 4 (graphite-black)



2113/552113
neutral 3 (asphalt black)



2112/552112
neutral 2 (anthracite)



2112/5716
neutral 1 (deep black)



2004/552004
dark azure



2008/552008
dark blue



2012/552012
dark turquoise



2016/552016
dark green



2020/552020
dark yellow



2024/552024
dark ochre



2028/552028
dark salmon



2032/552032
dark oxide red



2036/552036
dark stone grey



2040/552040
dark sand grey



2003/552003
medium azure



2007/552007
medium blue



2011/552011
medium turquoise



2015/552015
medium green



2019/552019
medium yellow



2023/552023
medium ochre



2027/552027
medium salmon



2031/552031
medium oxide red



2035/552035
medium stone grey



2039/552039
medium sand grey



2002/552002
azur hell

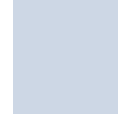

2006/552006
light blue



2010/552010
light turquoise



2014/552014
light green



2018/552018
light yellow



2022/552022
light ochre



2026/552026
light salmon



2030/552030
light oxide red



2034/552034
light stone grey



2038/552038
light sand grey



2001/552001
light azure



2005/552005
active blue



2009/552009
active turquoise



2013/552013
active green



2017/552017
active yellow



2021/552021
active ochre



2025/552025
active salmon



2029/552029
active oxide red



2033/552033
active stone grey



2037/552037
active sand grey



2504
deep anthracite



2508
deep blue



2512
deep green



2516
deep yellow



2520
deep orange



2524
deep red

Formats Stoneware

Mosaic 1 x 1 cm, 3/8 x 3/8 in

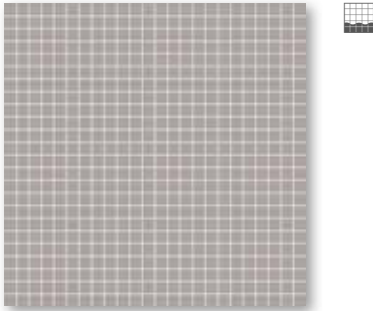

Mosaic sheet 30 x 30 cm, 12 x 12 in, smooth

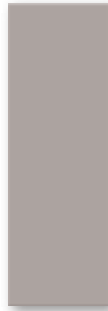

Floor/wall tile
10 x 30 cm, 4 x 12 in, smooth

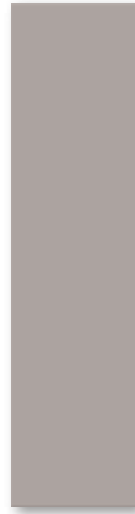

Floor/wall tile
12,5 x 50 cm, 5 x 20 in, smooth

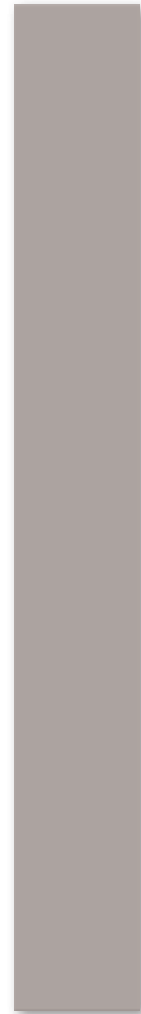

Floor/wall tile
12.5 x 100 cm, 5 x 40 in, smooth

Mosaic 2.5 x 2.5 cm, 1 x 1 in

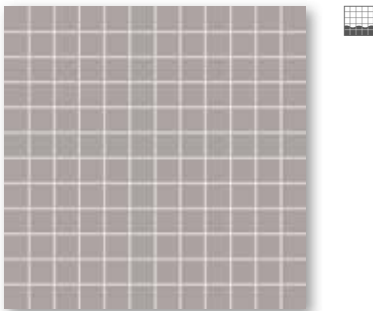

Mosaic sheet 30 x 30 cm, 12 x 12 in, smooth



Floor/wall tile
15 x 15 cm, 6 x 6 in, smooth



Floor/wall tile
20 x 20 cm, 8 x 8 in, smooth

Mosaic 5 x 5 cm, 2 x 2 in

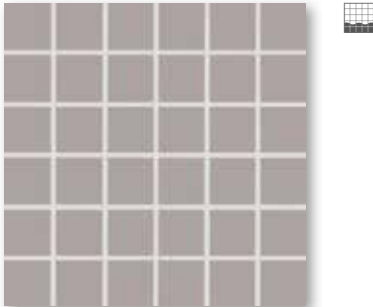

Mosaic sheet 30 x 30 cm, 12 x 12 in, smooth



Floor/wall tile
20 x 40 cm, 8 x 16 in, smooth

Mosaic 10 x 10 cm, 4 x 4 in

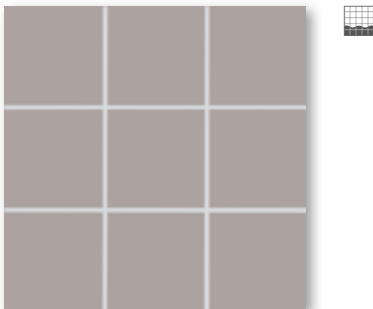

Mosaic sheet 30 x 30 cm, 12 x 12 in, smooth



Mosaics glued thermoplastically on back of AGROB BUCHTAL can be used not only in dry zones but also without any problems in underwater areas (e.g. swimming pools/whirlpools) as well as in permanently wet areas.

Do you already know our Mosaic Designer at our website www.agrob-buchtal.com?

There, you will have the possibility of designing your individual color gradients, mosaic compositions and the laying of pictures.

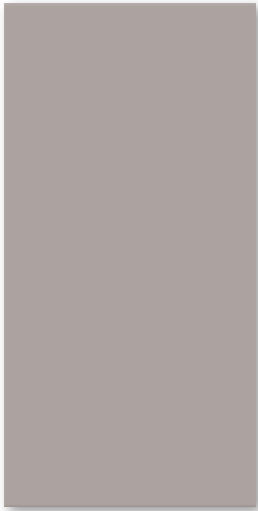

Floor/wall tile
25 x 50 cm, 10 x 20 in, smooth



Floor/wall tile
30 x 30 cm, 12 x 12 in, smooth

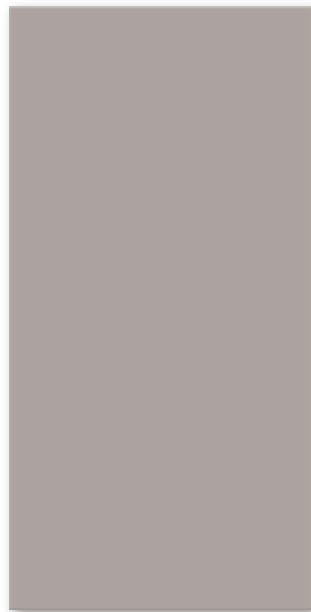

Floor/wall tile
30 x 60 cm, 12 x 24 in, smooth

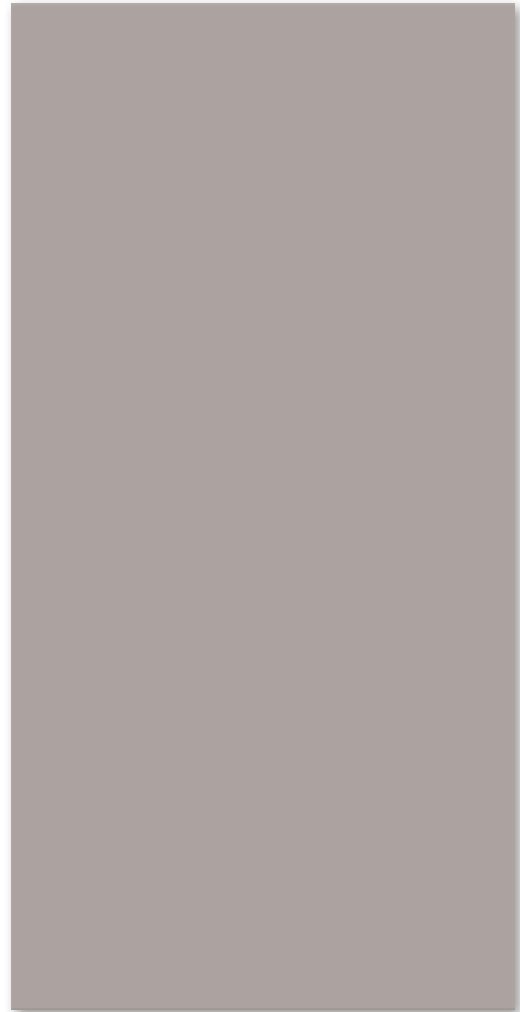

Floor/wall tile
50 x 100 cm, 20 x 40 in, smooth



Cove skirting,
smooth
10 x 10 cm
4 x 4 in, smooth



Internal
corner,
smooth



External
corner,
smooth

Dry-pressed Ceramic Tiles, DIN EN 14411, group Bl_b, glazed (GL) for floor and wall coverings
in indoor and outdoor areas (stoneware tiles) // Extruded Ceramic Tiles, Precision, DIN EN 14411,
group Al_b, glazed (GL) for floor and wall coverings in indoor and outdoor areas (stoneware tiles)

Mosaic

Floor/Wall Tiles

1 x 1 cm^{3/5}

2.5 x 2.5 cm^{3/5}

5 x 5 cm^{3/5}

10 x 10 cm^{3/5/7}

10 x 30 cm

12.5 x 50 cm²

12.5 x 100 cm²

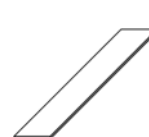
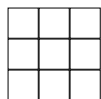
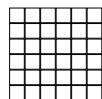
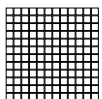
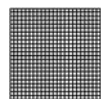

Sheet: 313 x 313 mm

Sheet: 297 x 297 mm

Sheet: 297 x 297 mm

Sheet: 297 x 297 mm

1 x 1 / 3/8 x 3/8	2.5 x 2.5 / 1 x 1	5 x 5 / 2 x 2	10 x 10 / 4 x 4	703	341550HK	352010HK	Model number
12 x 12 x 6.5 mm	23 x 23 x 6.5 mm	47 x 47 x 6.5 mm	97 x 97 x 6.5 mm	10 x 30 / 4 x 12	12,5 x 50 / 5 x 20	12,5 x 100 / 5 x 40	Nom. dim. - cm/in
smooth, for op-theat.	smooth, for op-theat.	smooth, for op-theat.	smooth, for op-theat.	smooth, silky-matt ⁶	smooth, silky-matt ⁶	smooth, silky-matt ⁶	Surface
10 sheets	11 sheets	11 sheets	11 sheets	11 sheets	16.000	8.000	m ² - pieces
11.930	12.100	12.331	13.101	12.333	17.040	17.040	m ² - kg
10 sheets	11 sheets	11 sheets	11 sheets	38	8	10	Bundle - pieces
1.000	1.000	1.000	1.000	1.140	0.500	1.250	Bundle - m ²
11.930	12.100	12.331	13.101	14.060	8.520	21.300	Bundle - kg
24.000	48.000	64.000	64.000	95.761	55.000	67.500	Pallet - m ²
286.320	580.800	789.184	838.464	1,181.040	937.200	1,150.200	Pallet - kg
Blb	Blb	Blb	Blb	Alb	Alb	Alb	Product standard
1	1	1	1	1	1	1	Stress group
		705-2121H	710-2121H	703-2121H	700i-341550HK	700i-352010HK	4 neutral 10 (active
		Price gr. A187 (m ²)	Price gr. A142 (m ²)	Price gr. A142 (m ²)	Price gr. A211 (m ²)	Price gr. A265 (m ²)	white glossy) <input type="checkbox"/>
701-2120H¹	702-2120H	705-2120H	710-2120H	703-2120H	701i-341550HK	701i-352010HK	4 neutral 10
Price gr. A361 (m ²)	Price gr. A229 (m ²)	Price gr. A187 (m ²)	Price gr. A142 (m ²)	Price gr. A142 (m ²)	Price gr. A211 (m ²)	Price gr. A265 (m ²)	(active white) <input type="checkbox"/>
701-2119H¹	702-2119H¹	705-2119H	710-2119H	703-2119H¹	552119-341550HK¹	552119-352010HK¹	4 neutral 9
Price gr. A361 (m ²)	Price gr. A280 (m ²)	Price gr. A211 (m ²)	Price gr. A157 (m ²)	Price gr. A187 (m ²)	Price gr. A259 (m ²)	Price gr. A313 (m ²)	(white-grey) <input type="checkbox"/>
701-2118H¹	702-2118H	705-2118H	710-2118H	703-2118H	552118-341550HK	552118-352010HK	4 neutral 8
Price gr. A361 (m ²)	Price gr. A229 (m ²)	Price gr. A187 (m ²)	Price gr. A142 (m ²)	Price gr. A142 (m ²)	Price gr. A211 (m ²)	Price gr. A265 (m ²)	(light-grey) <input type="checkbox"/>
701-2117H¹	702-2117H¹	705-2117H	710-2117H	703-2117H¹	552117-341550HK	552117-352010HK	4 neutral 7
Price gr. A361 (m ²)	Price gr. A280 (m ²)	Price gr. A211 (m ²)	Price gr. A157 (m ²)	Price gr. A187 (m ²)	Price gr. A229 (m ²)	Price gr. A289 (m ²)	(pebble grey) <input type="checkbox"/>
701-2116H¹	702-2116H¹	705-2116H¹	710-2116H¹	703-2116H¹	552116-341550HK¹	552116-352010HK¹	3 neutral 6
Price gr. A361 (m ²)	Price gr. A280 (m ²)	Price gr. A238 (m ²)	Price gr. A187 (m ²)	Price gr. A187 (m ²)	Price gr. A259 (m ²)	Price gr. A313 (m ²)	(pearl grey) <input type="checkbox"/>
701-2115H¹	702-2115H¹	705-2115H	710-2115H	703-2115H¹	552115-341550HK¹	552115-352010HK¹	3 neutral 5
Price gr. A361 (m ²)	Price gr. A280 (m ²)	Price gr. A211 (m ²)	Price gr. A157 (m ²)	Price gr. A187 (m ²)	Price gr. A259 (m ²)	Price gr. A313 (m ²)	(basalt grey) <input type="checkbox"/>
701-2114H¹	702-2114H¹	705-2114H	710-2114H	703-2114H^{1/4}	552114-341550HK^{1/4}	552114-352010HK^{1/4}	3 neutral 4
Price gr. A361 (m ²)	Price gr. A280 (m ²)	Price gr. A211 (m ²)	Price gr. A157 (m ²)	Price gr. A187 (m ²)	Price gr. A259 (m ²)	Price gr. A313 (m ²)	(graphite black) <input type="checkbox"/>
701-2113H¹	702-2113H¹	705-2113H	710-2113H	703-2113H	552113-341550HK	552113-352010HK	3 neutral 3
Price gr. A361 (m ²)	Price gr. A280 (m ²)	Price gr. A211 (m ²)	Price gr. A157 (m ²)	Price gr. A157 (m ²)	Price gr. A229 (m ²)	Price gr. A289 (m ²)	(asphalt black) <input type="checkbox"/>
701-2112H¹	702-2112H¹	705-2112H	710-2112H	703-2112H¹	552112-341550HK¹	552112-352010HK¹	2 neutral 2
Price gr. A361 (m ²)	Price gr. A280 (m ²)	Price gr. A211 (m ²)	Price gr. A157 (m ²)	Price gr. A187 (m ²)	Price gr. A259 (m ²)	Price gr. A313 (m ²)	(anthracite) <input type="checkbox"/>
701-2111H¹	702-2111H	705-2111H	710-2111H	703-2111H⁴	5716-341550HK^{1/4}	5716-352010HK^{1/4}	1 neutral 1
Price gr. A361 (m ²)	Price gr. A250 (m ²)	Price gr. A211 (m ²)	Price gr. A157 (m ²)	Price gr. A187 (m ²)	Price gr. A259 (m ²)	Price gr. A313 (m ²)	(deep black) <input type="checkbox"/>
701-2001H¹	702-2001H¹	705-2001H	710-2001H	703-2001H	552001-341550HK	552001-352010HK	2 active azure
Price gr. A361 (m ²)	Price gr. A280 (m ²)	Price gr. A211 (m ²)	Price gr. A157 (m ²)	Price gr. A157 (m ²)	Price gr. A229 (m ²)	Price gr. A289 (m ²)	(active) <input type="checkbox"/>
701-2002H¹	702-2002H¹	705-2002H	710-2002H	703-2002H¹	552002-341550HK¹	552002-352010HK¹	4 light azure
Price gr. A361 (m ²)	Price gr. A280 (m ²)	Price gr. A211 (m ²)	Price gr. A157 (m ²)	Price gr. A187 (m ²)	Price gr. A259 (m ²)	Price gr. A313 (m ²)	(active) <input type="checkbox"/>
701-2003H¹	702-2003H	705-2003H	710-2003H	703-2003H	552003-341550HK	552003-352010HK	3 medium azure
Price gr. A361 (m ²)	Price gr. A250 (m ²)	Price gr. A211 (m ²)	Price gr. A157 (m ²)	Price gr. A157 (m ²)	Price gr. A229 (m ²)	Price gr. A289 (m ²)	(active) <input type="checkbox"/>
701-2004H¹	702-2004H	705-2004H	710-2004H	703-2004H¹	552004-341550HK¹	552004-352010HK¹	2 dark azure
Price gr. A361 (m ²)	Price gr. A250 (m ²)	Price gr. A211 (m ²)	Price gr. A157 (m ²)	Price gr. A187 (m ²)	Price gr. A259 (m ²)	Price gr. A313 (m ²)	(active) <input type="checkbox"/>
701-2005H¹	702-2005H¹	705-2005H	710-2005H	703-2005H¹	552005-341550HK¹	552005-352010HK¹	2 active blue
Price gr. A361 (m ²)	Price gr. A280 (m ²)	Price gr. A211 (m ²)	Price gr. A157 (m ²)	Price gr. A187 (m ²)	Price gr. A259 (m ²)	Price gr. A313 (m ²)	(active) <input type="checkbox"/>
701-2006H¹	702-2006H¹	705-2006H	710-2006H	703-2006H¹	552006-341550HK¹	552006-352010HK¹	4 light blue
Price gr. A361 (m ²)	Price gr. A280 (m ²)	Price gr. A211 (m ²)	Price gr. A157 (m ²)	Price gr. A187 (m ²)	Price gr. A259 (m ²)	Price gr. A313 (m ²)	(active) <input type="checkbox"/>
701-2007H¹	702-2007H¹	705-2007H	710-2007H	703-2007H¹	552007-341550HK¹	552007-352010HK¹	3 medium blue
Price gr. A361 (m ²)	Price gr. A280 (m ²)	Price gr. A211 (m ²)	Price gr. A157 (m ²)	Price gr. A187 (m ²)	Price gr. A259 (m ²)	Price gr. A313 (m ²)	(active) <input type="checkbox"/>
701-2008H¹	702-2008H	705-2008H	710-2008H	703-2008H¹	552008-341550HK¹	552008-352010HK¹	2 dark blue
Price gr. A361 (m ²)	Price gr. A250 (m ²)	Price gr. A211 (m ²)	Price gr. A157 (m ²)	Price gr. A187 (m ²)	Price gr. A259 (m ²)	Price gr. A313 (m ²)	(active) <input type="checkbox"/>
701-2009H¹	702-2009H¹	705-2009H	710-2009H	703-2009H¹	552009-341550HK¹	552009-352010HK¹	2 active turquoise
Price gr. A361 (m ²)	Price gr. A280 (m ²)	Price gr. A211 (m ²)	Price gr. A157 (m ²)	Price gr. A187 (m ²)	Price gr. A259 (m ²)	Price gr. A313 (m ²)	(active) <input type="checkbox"/>
701-2010H¹	702-2010H¹	705-2010H	710-2010H	703-2010H¹	552010-341550HK¹	552010-352010HK¹	4 light turquoise
Price gr. A361 (m ²)	Price gr. A280 (m ²)	Price gr. A211 (m ²)	Price gr. A157 (m ²)	Price gr. A187 (m ²)	Price gr. A259 (m ²)	Price gr. A313 (m ²)	(active) <input type="checkbox"/>
701-2011H¹	702-2011H¹	705-2011H	710-2011H	703-2011H¹	552011-341550HK¹	552011-352010HK¹	3 medium turquoise
Price gr. A361 (m ²)	Price gr. A280 (m ²)	Price gr. A211 (m ²)	Price gr. A157 (m ²)	Price gr. A187 (m ²)	Price gr. A259 (m ²)	Price gr. A313 (m ²)	(active) <input type="checkbox"/>
701-2012H¹	702-2012H¹	705-2012H	710-2012H	703-2012H^{1/4}	552012-341550HK^{1/4}	552012-352010HK^{1/4}	2 dark turquoise
Price gr. A361 (m ²)	Price gr. A280 (m ²)	Price gr. A211 (m ²)	Price gr. A157 (m ²)	Price gr. A187 (m ²)	Price gr. A259 (m ²)	Price gr. A313 (m ²)	(active) <input type="checkbox"/>
701-2013H¹	702-2013H¹	705-2013H	710-2013H	703-2013H¹	552013-341550HK¹	552013-352010HK¹	2 active green
Price gr. A361 (m ²)	Price gr. A280 (m ²)	Price gr. A211 (m ²)	Price gr. A157 (m ²)	Price gr. A187 (m ²)	Price gr. A259 (m ²)	Price gr. A313 (m ²)	(active) <input type="checkbox"/>
701-2014H¹	702-2014H¹	705-2014H	710-2014H	703-2014H¹	552014-341550HK¹	552014-352010HK¹	4 light green
Price gr. A361 (m ²)	Price gr. A280 (m ²)	Price gr. A211 (m ²)	Price gr. A157 (m ²)	Price gr. A187 (m ²)	Price gr. A259 (m ²)	Price gr. A313 (m ²)	(active) <input type="checkbox"/>
701-2015H¹	702-2015H¹	705-2015H	710-2015H	703-2015H¹	552015-341550HK¹	552015-352010HK¹	3 medium green
Price gr. A361 (m ²)	Price gr. A280 (m ²)	Price gr. A211 (m ²)	Price gr. A157 (m ²)	Price gr. A187 (m ²)	Price gr. A259 (m ²)	Price gr. A313 (m ²)	(active) <input type="checkbox"/>
701-2016H¹	702-2016H¹	705-2016H	710-2016H	703-2016H¹	552016-341550HK¹	552016-352010HK¹	2 dark green
Price gr. A361 (m ²)	Price gr. A280 (m ²)	Price gr. A211 (m ²)	Price gr. A157 (m ²)	Price gr. A187 (m ²)	Price gr. A259 (m ²)	Price gr. A313 (m ²)	(active) <input type="checkbox"/>



⁴ Production-related color deviations from the standard are possible.
⁵ Upon request, defined color nuances and mosaic pictures can also be supplied.

⁶ Exception: neutral 10 (glossy), smooth, glossy
⁷ Overglazed edges proportionately in the sheet.
Shower tub system, refer to series Plural non-slip, page 195/197



Floor/Wall Tiles

15 x 15 cm



20 x 20 cm



20 x 40 cm



25 x 50 cm²



30 x 30 cm²



30 x 60 cm²



50 x 100 cm²

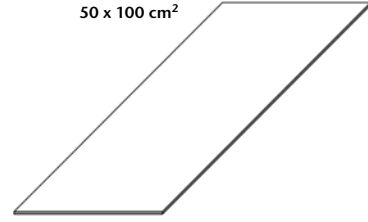

Model number	15 x 15 cm	20 x 20 cm	20 x 40 cm	25 x 50 cm ²	30 x 30 cm ²	30 x 60 cm ²	50 x 100 cm ²
Nom. dim. - cm/in	15 x 15 / 6 x 6	20 x 20 / 8 x 8	20 x 40 / 8 x 16	25 x 50 / 10 x 20	30 x 30 / 12 x 12	30 x 60 / 12 x 24	50 x 100 / 20 x 40
Work size	147 x 147 x 6.5 mm	197 x 197 x 6.5 mm	197 x 397 x 6.5 mm	247 x 497 x 8 mm	297 x 297 x 8 mm	297 x 597 x 8 mm	497 x 997 x 8 mm
Surface	smooth, for op-theat.	smooth, for op-theat.	smooth, for op-theat.	smooth, silky-matt ⁴	smooth, silky-matt ⁴	smooth, silky-matt ⁴	smooth, silky-matt ⁴
m ² - pieces	44.000	25.000	12.500	8.000	11.111	5.556	2.000
m ² - kg	13.816	13.875	14.100	17.040	17.222	17.413	18.080
Bundle - pieces	44	25	16	9	14	6	2
Bundle - m ²	1.000	1.000	1.280	1.125	1.260	1.080	1.000
Bundle - kg	13.816	13.875	18.048	19.170	21.700	18.804	18.080
Pallet - m ²	80.000	72.000	72.960	40.500	52.921	43.197	52.000
Pallet - kg	1,105.280	999.000	1,028.736	690.120	911.400	752.160	940.160
Product standard	Blb	Blb	Blb	Alb	Alb	Alb	Alb
Stress group	1	1	1	1	2	1	1
neutral 10 (active white glossy) <input type="checkbox"/>	4			700i-342550HK Price gr. A157 (m ²)	730 Price gr. A166 (m ²)	760 Price gr. A166 (m ²)	352050HK Price gr. A211 (m ²)
neutral 10 (active white) <input type="checkbox"/>	4	715-2120H Price gr. A115 (m ²)	720-2120H Price gr. A115 (m ²)	740-2120H Price gr. A127 (m ²)	701i-342550HK Price gr. A157 (m ²)	730-2120H Price gr. A166 (m ²)	760-2120H Price gr. A166 (m ²)
neutral 9 (white-grey) <input type="checkbox"/>	4	715-2119H ¹ Price gr. A166 (m ²)	720-2119H ¹ Price gr. A166 (m ²)	740-2119H ¹ Price gr. A173 (m ²)	552119-342550HK Price gr. A181 (m ²)	730-2119H ¹ Price gr. A217 (m ²)	760-2119H ¹ Price gr. A217 (m ²)
neutral 8 (light-grey) <input type="checkbox"/>	4	715-2118H Price gr. A115 (m ²)	720-2118H Price gr. A115 (m ²)	740-2118H Price gr. A127 (m ²)	552118-342550HK Price gr. A157 (m ²)	730-2118H Price gr. A166 (m ²)	760-2118H Price gr. A166 (m ²)
neutral 7 (pebble grey) <input type="checkbox"/>	4	715-2117H ¹ Price gr. A166 (m ²)	720-2117H ¹ Price gr. A166 (m ²)	740-2117H ¹ Price gr. A173 (m ²)	552117-342550HK Price gr. A181 (m ²)	730-2117H ¹ Price gr. A217 (m ²)	760-2117H ¹ Price gr. A217 (m ²)
neutral 6 (pearl grey) <input type="checkbox"/>	3	715-2116H ¹ Price gr. A166 (m ²)	720-2116H ¹ Price gr. A166 (m ²)	740-2116H ¹ Price gr. A173 (m ²)	552116-342550HK Price gr. A181 (m ²)	730-2116H ¹ Price gr. A217 (m ²)	760-2116H ¹ Price gr. A217 (m ²)
neutral 5 (basalt grey) <input type="checkbox"/>	3	715-2115H ¹ Price gr. A166 (m ²)	720-2115H ¹ Price gr. A166 (m ²)	740-2115H ¹ Price gr. A173 (m ²)	552115-342550HK Price gr. A181 (m ²)	730-2115H ¹ Price gr. A217 (m ²)	760-2115H ¹ Price gr. A217 (m ²)
neutral 4 (graphite black) <input type="checkbox"/>	3	715-2114H Price gr. A142 (m ²)	720-2114H Price gr. A142 (m ²)	740-2114H ¹ Price gr. A173 (m ²)	552114-342550HK ³ Price gr. A181 (m ²)	730-2114H ^{1/3} Price gr. A217 (m ²)	760-2114H ^{1/3} Price gr. A217 (m ²)
neutral 3 (asphalt black) <input type="checkbox"/>	3	715-2113H ¹ Price gr. A166 (m ²)	720-2113H ¹ Price gr. A166 (m ²)	740-2113H ¹ Price gr. A173 (m ²)	552113-342550HK Price gr. A181 (m ²)	730-2113H Price gr. A187 (m ²)	760-2113H Price gr. A187 (m ²)
neutral 2 (anthracite) <input type="checkbox"/>	2	715-2112H Price gr. A142 (m ²)	720-2112H Price gr. A142 (m ²)	740-2112H ¹ Price gr. A173 (m ²)	552112-342550HK Price gr. A181 (m ²)	730-2112H ¹ Price gr. A217 (m ²)	760-2112H Price gr. A187 (m ²)
neutral 1 (deep black) <input type="checkbox"/>	1	715-2111H Price gr. A142 (m ²)	720-2111H Price gr. A142 (m ²)	740-2111H Price gr. A151 (m ²)	5716-342550HK ³ Price gr. A181 (m ²)	730-2111H ³ Price gr. A217 (m ²)	760-2111H ^{1/3} Price gr. A217 (m ²)
active azure <input type="checkbox"/>	2	715-2001H ¹ Price gr. A166 (m ²)	720-2001H ¹ Price gr. A166 (m ²)	740-2001H ¹ Price gr. A173 (m ²)	552001-342550HK Price gr. A181 (m ²)	730-2001H Price gr. A187 (m ²)	760-2001H Price gr. A187 (m ²)
light azure <input type="checkbox"/>	4	715-2002H ¹ Price gr. A166 (m ²)	720-2002H ¹ Price gr. A166 (m ²)	740-2002H ¹ Price gr. A173 (m ²)	552002-342550HK Price gr. A181 (m ²)	730-2002H ¹ Price gr. A217 (m ²)	760-2002H ¹ Price gr. A217 (m ²)
medium azure <input type="checkbox"/>	3	715-2003H Price gr. A142 (m ²)	720-2003H Price gr. A142 (m ²)	740-2003H Price gr. A151 (m ²)	552003-342550HK Price gr. A181 (m ²)	730-2003H Price gr. A187 (m ²)	760-2003H Price gr. A187 (m ²)
dark azure <input type="checkbox"/>	2	715-2004H ¹ Price gr. A166 (m ²)	720-2004H ¹ Price gr. A142 (m ²)	740-2004H ¹ Price gr. A173 (m ²)	552004-342550HK Price gr. A181 (m ²)	730-2004H ¹ Price gr. A217 (m ²)	760-2004H ¹ Price gr. A217 (m ²)
active blue <input type="checkbox"/>	2	715-2005H ¹ Price gr. A166 (m ²)	720-2005H ¹ Price gr. A166 (m ²)	740-2005H ¹ Price gr. A173 (m ²)	552005-342550HK Price gr. A181 (m ²)	730-2005H ¹ Price gr. A217 (m ²)	760-2005H ¹ Price gr. A217 (m ²)
light blue <input type="checkbox"/>	4	715-2006H ¹ Price gr. A166 (m ²)	720-2006H ¹ Price gr. A166 (m ²)	740-2006H ¹ Price gr. A173 (m ²)	552006-342550HK Price gr. A181 (m ²)	730-2006H ¹ Price gr. A217 (m ²)	760-2006H ¹ Price gr. A217 (m ²)
medium blue <input type="checkbox"/>	3	715-2007H Price gr. A142 (m ²)	720-2007H Price gr. A142 (m ²)	740-2007H Price gr. A151 (m ²)	552007-342550HK Price gr. A181 (m ²)	730-2007H ¹ Price gr. A217 (m ²)	760-2007H ¹ Price gr. A217 (m ²)
dark blue <input type="checkbox"/>	2	715-2008H ¹ Price gr. A166 (m ²)	720-2008H ¹ Price gr. A142 (m ²)	740-2008H ¹ Price gr. A173 (m ²)	552008-342550HK Price gr. A181 (m ²)	730-2008H ¹ Price gr. A217 (m ²)	760-2008H ¹ Price gr. A217 (m ²)
active turquoise <input type="checkbox"/>	2	715-2009H ¹ Price gr. A166 (m ²)	720-2009H ¹ Price gr. A166 (m ²)	740-2009H ¹ Price gr. A173 (m ²)	552009-342550HK Price gr. A181 (m ²)	730-2009H ¹ Price gr. A217 (m ²)	760-2009H ¹ Price gr. A217 (m ²)
light turquoise <input type="checkbox"/>	4	715-2010H Price gr. A142 (m ²)	720-2010H Price gr. A142 (m ²)	740-2010H Price gr. A151 (m ²)	552010-342550HK Price gr. A181 (m ²)	730-2010H ¹ Price gr. A217 (m ²)	760-2010H ¹ Price gr. A217 (m ²)
medium turquoise <input type="checkbox"/>	3	715-2011H ¹ Price gr. A166 (m ²)	720-2011H ¹ Price gr. A166 (m ²)	740-2011H ¹ Price gr. A173 (m ²)	552011-342550HK Price gr. A181 (m ²)	730-2011H ¹ Price gr. A217 (m ²)	760-2011H ¹ Price gr. A217 (m ²)
dark turquoise <input type="checkbox"/>	2	715-2012H ¹ Price gr. A166 (m ²)	720-2012H ¹ Price gr. A166 (m ²)	740-2012H ¹ Price gr. A173 (m ²)	552012-342550HK ³ Price gr. A181 (m ²)	730-2012H ^{1/3} Price gr. A217 (m ²)	760-2012H ^{1/3} Price gr. A217 (m ²)
active green <input type="checkbox"/>	2	715-2013H ¹ Price gr. A166 (m ²)	720-2013H ¹ Price gr. A166 (m ²)	740-2013H ¹ Price gr. A173 (m ²)	552013-342550HK Price gr. A181 (m ²)	730-2013H ¹ Price gr. A217 (m ²)	760-2013H ¹ Price gr. A217 (m ²)
light green <input type="checkbox"/>	4	715-2014H Price gr. A142 (m ²)	720-2014H Price gr. A142 (m ²)	740-2014H Price gr. A151 (m ²)	552014-342550HK Price gr. A181 (m ²)	730-2014H ¹ Price gr. A217 (m ²)	760-2014H ¹ Price gr. A217 (m ²)
medium green <input type="checkbox"/>	3	715-2015H ¹ Price gr. A166 (m ²)	720-2015H ¹ Price gr. A166 (m ²)	740-2015H ¹ Price gr. A173 (m ²)	552015-342550HK Price gr. A181 (m ²)	730-2015H ¹ Price gr. A217 (m ²)	760-2015H ¹ Price gr. A217 (m ²)
dark green <input type="checkbox"/>	2	715-2016H ¹ Price gr. A166 (m ²)	720-2016H ¹ Price gr. A166 (m ²)	740-2016H ¹ Price gr. A173 (m ²)	552016-342550HK Price gr. A181 (m ²)	730-2016H ¹ Price gr. A217 (m ²)	760-2016H ¹ Price gr. A217 (m ²)



¹ Production-related color deviations from the standard are possible.
² Exception: neutral 10 (glossy), smooth, glossy

Mosaics

Floor/Wall Tiles

1 x 1 cm^{3/5}

2.5 x 2.5 cm^{3/5}

5 x 5 cm^{3/5}

10 x 10 cm^{3/5/6}

10 x 30 cm

12.5 x 50 cm²

12.5 x 100 cm²

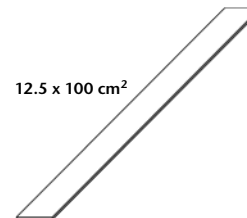
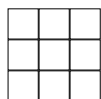
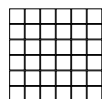
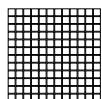
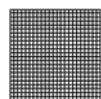

Sheet: 313 x 313 mm

Sheet: 297 x 297 mm

Sheet: 297 x 297 mm

Sheet: 297 x 297 mm

1 x 1 / 3/8 x 3/8 12 x 12 x 6.5 mm smooth, for op-theat. 10 sheets 11.930 10 sheets 1.000 11.930 24.000 286.320 Blb	2.5 x 2.5 / 1 x 1 23 x 23 x 6.5 mm smooth, for op-theat. 11 sheets 12.100 11 sheets 1.000 12.100 48.000 580.800 Blb	5 x 5 / 2 x 2 47 x 47 x 6.5 mm smooth, for op-theat. 11 sheets 12.331 11 sheets 1.000 12.331 64.000 789.184 Blb	10 x 10 / 4 x 4 97 x 97 x 6.5 mm smooth, for op-theat. 11 sheets 13.101 11 sheets 1.000 13.101 64.000 838.464 Blb	703 10 x 30 / 4 x 12 97 x 297 x 6 mm smooth, silky-matt 33.333 12.333 38 1.140 14.060 95.761 1,181.040 Alb	341550HK 12.5 x 50 / 5 x 20 122 x 497 x 8 mm smooth, silky-matt 16.000 17.040 8 0.500 8.520 55.000 937.200 Alb	352010HK 12.5 x 100 / 5 x 40 122 x 997 x 8 mm smooth, silky-matt 8.000 17.040 10 1.250 21.300 67.500 1,150.200 Alb	Model number Nom. dim. - cm/in Work size Surface m ² - pieces m ² - kg Bundle - pieces Bundle - m ² Bundle - kg Pallet - m ² Pallet - kg Product standard Stress group
1	1	1	1	1	1	1	2
701-2017H ¹ Price gr. A361 (m ²)	702-2017H ¹ Price gr. A280 (m ²)	705-2017H Price gr. A211 (m ²)	710-2017H Price gr. A157 (m ²)	703-2017H ^{1/4} Price gr. A187 (m ²)	552017-341550HK ^{1/4} Price gr. A259 (m ²)	552017-352010HK ^{1/4} Price gr. A313 (m ²)	active yellow <input type="checkbox"/>
701-2018H ¹ Price gr. A361 (m ²)	702-2018H ¹ Price gr. A280 (m ²)	705-2018H Price gr. A211 (m ²)	710-2018H Price gr. A157 (m ²)	703-2018H ¹ Price gr. A187 (m ²)	552018-341550HK ¹ Price gr. A259 (m ²)	552018-352010HK ¹ Price gr. A313 (m ²)	light yellow <input type="checkbox"/>
701-2019H ¹ Price gr. A361 (m ²)	702-2019H ¹ Price gr. A280 (m ²)	705-2019H Price gr. A211 (m ²)	710-2019H Price gr. A157 (m ²)	703-2019H ¹ Price gr. A187 (m ²)	552019-341550HK ¹ Price gr. A259 (m ²)	552019-352010HK ¹ Price gr. A313 (m ²)	medium yellow <input type="checkbox"/>
701-2020H ¹ Price gr. A361 (m ²)	702-2020H ¹ Price gr. A280 (m ²)	705-2020H Price gr. A211 (m ²)	710-2020H Price gr. A157 (m ²)	703-2020H ^{1/4} Price gr. A187 (m ²)	552020-341550HK ^{1/4} Price gr. A259 (m ²)	552020-352010HK ^{1/4} Price gr. A313 (m ²)	dark yellow <input type="checkbox"/>
701-2021H ¹ Price gr. A361 (m ²)	702-2021H ¹ Price gr. A280 (m ²)	705-2021H Price gr. A211 (m ²)	710-2021H Price gr. A157 (m ²)	703-2021H ^{1/4} Price gr. A187 (m ²)	552021-341550HK ^{1/4} Price gr. A259 (m ²)	552021-352010HK ^{1/4} Price gr. A313 (m ²)	active ochre <input type="checkbox"/>
701-2022H ¹ Price gr. A361 (m ²)	702-2022H ¹ Price gr. A280 (m ²)	705-2022H Price gr. A211 (m ²)	710-2022H Price gr. A157 (m ²)	703-2022H ¹ Price gr. A187 (m ²)	552022-341550HK ¹ Price gr. A259 (m ²)	552022-352010HK ¹ Price gr. A313 (m ²)	light ochre <input type="checkbox"/>
701-2023H ¹ Price gr. A361 (m ²)	702-2023H ¹ Price gr. A280 (m ²)	705-2023H Price gr. A211 (m ²)	710-2023H Price gr. A157 (m ²)	703-2023H ¹ Price gr. A187 (m ²)	552023-341550HK ¹ Price gr. A259 (m ²)	552023-352010HK ¹ Price gr. A313 (m ²)	medium ochre <input type="checkbox"/>
701-2024H ¹ Price gr. A361 (m ²)	702-2024H ¹ Price gr. A280 (m ²)	705-2024H Price gr. A211 (m ²)	710-2024H Price gr. A157 (m ²)	703-2024H ¹ Price gr. A187 (m ²)	552024-341550HK ¹ Price gr. A259 (m ²)	552024-352010HK ¹ Price gr. A313 (m ²)	dark ochre <input type="checkbox"/>
701-2025H ¹ Price gr. A361 (m ²)	702-2025H ¹ Price gr. A280 (m ²)	705-2025H Price gr. A211 (m ²)	710-2025H Price gr. A157 (m ²)	703-2025H ^{1/4} Price gr. A187 (m ²)	552025-341550HK ^{1/4} Price gr. A259 (m ²)	552025-352010HK ^{1/4} Price gr. A313 (m ²)	active salmon <input type="checkbox"/>
701-2026H ¹ Price gr. A361 (m ²)	702-2026H ¹ Price gr. A280 (m ²)	705-2026H Price gr. A211 (m ²)	710-2026H Price gr. A157 (m ²)	703-2026H ¹ Price gr. A187 (m ²)	552026-341550HK ¹ Price gr. A259 (m ²)	552026-352010HK ¹ Price gr. A313 (m ²)	light salmon <input type="checkbox"/>
701-2027H ¹ Price gr. A361 (m ²)	702-2027H ¹ Price gr. A280 (m ²)	705-2027H Price gr. A211 (m ²)	710-2027H Price gr. A157 (m ²)	703-2027H ¹ Price gr. A187 (m ²)	552027-341550HK ¹ Price gr. A259 (m ²)	552027-352010HK ¹ Price gr. A313 (m ²)	medium salmon <input type="checkbox"/>
701-2028H ¹ Price gr. A361 (m ²)	702-2028H ¹ Price gr. A280 (m ²)	705-2028H Price gr. A211 (m ²)	710-2028H Price gr. A157 (m ²)	703-2028H ¹ Price gr. A187 (m ²)	552028-341550HK ¹ Price gr. A259 (m ²)	552028-352010HK ¹ Price gr. A313 (m ²)	dark salmon <input type="checkbox"/>
701-2029H ¹ Price gr. A361 (m ²)	702-2029H ¹ Price gr. A280 (m ²)	705-2029H Price gr. A211 (m ²)	710-2029H Price gr. A157 (m ²)	703-2029H ¹ Price gr. A187 (m ²)	552029-341550HK ¹ Price gr. A259 (m ²)	552029-352010HK ¹ Price gr. A313 (m ²)	active oxide red <input type="checkbox"/>
701-2030H ¹ Price gr. A361 (m ²)	702-2030H ¹ Price gr. A280 (m ²)	705-2030H Price gr. A211 (m ²)	710-2030H Price gr. A157 (m ²)	703-2030H ¹ Price gr. A187 (m ²)	552030-341550HK ¹ Price gr. A259 (m ²)	552030-352010HK ¹ Price gr. A313 (m ²)	light oxide red <input type="checkbox"/>
701-2031H ¹ Price gr. A361 (m ²)	702-2031H ¹ Price gr. A280 (m ²)	705-2031H Price gr. A211 (m ²)	710-2031H Price gr. A157 (m ²)	703-2031H ¹ Price gr. A187 (m ²)	552031-341550HK ¹ Price gr. A259 (m ²)	552031-352010HK ¹ Price gr. A313 (m ²)	medium oxide red <input type="checkbox"/>
701-2032H ¹ Price gr. A361 (m ²)	702-2032H ¹ Price gr. A280 (m ²)	705-2032H Price gr. A211 (m ²)	710-2032H Price gr. A157 (m ²)	703-2032H ¹ Price gr. A187 (m ²)	552032-341550HK ¹ Price gr. A259 (m ²)	552032-352010HK ¹ Price gr. A313 (m ²)	dark oxide red <input type="checkbox"/>
701-2033H ¹ Price gr. A361 (m ²)	702-2033H ¹ Price gr. A280 (m ²)	705-2033H Price gr. A211 (m ²)	710-2033H Price gr. A157 (m ²)	703-2033H ¹ Price gr. A187 (m ²)	552033-341550HK ¹ Price gr. A259 (m ²)	552033-352010HK ¹ Price gr. A313 (m ²)	active stone grey <input type="checkbox"/>
701-2034H ¹ Price gr. A361 (m ²)	702-2034H ¹ Price gr. A280 (m ²)	705-2034H Price gr. A211 (m ²)	710-2034H Price gr. A157 (m ²)	703-2034H ¹ Price gr. A187 (m ²)	552034-341550HK ¹ Price gr. A259 (m ²)	552034-352010HK ¹ Price gr. A313 (m ²)	light stone grey <input type="checkbox"/>
701-2035H ¹ Price gr. A361 (m ²)	702-2035H ¹ Price gr. A280 (m ²)	705-2035H Price gr. A211 (m ²)	710-2035H Price gr. A157 (m ²)	703-2035H Price gr. A157 (m ²)	552035-341550HK Price gr. A229 (m ²)	552035-352010HK Price gr. A289 (m ²)	medium stone grey <input type="checkbox"/>
701-2036H ¹ Price gr. A361 (m ²)	702-2036H ¹ Price gr. A280 (m ²)	705-2036H Price gr. A211 (m ²)	710-2036H Price gr. A157 (m ²)	703-2036H ¹ Price gr. A187 (m ²)	552036-341550HK ¹ Price gr. A259 (m ²)	552036-352010HK ¹ Price gr. A313 (m ²)	dark stone grey <input type="checkbox"/>
701-2037H ¹ Price gr. A361 (m ²)	702-2037H ¹ Price gr. A280 (m ²)	705-2037H Price gr. A211 (m ²)	710-2037H Price gr. A157 (m ²)	703-2037H ¹ Price gr. A187 (m ²)	552037-341550HK ¹ Price gr. A259 (m ²)	552037-352010HK ¹ Price gr. A313 (m ²)	active sand-grey <input type="checkbox"/>
701-2038H ¹ Price gr. A361 (m ²)	702-2038H ¹ Price gr. A280 (m ²)	705-2038H Price gr. A211 (m ²)	710-2038H Price gr. A157 (m ²)	703-2038H ¹ Price gr. A187 (m ²)	552038-341550HK ¹ Price gr. A259 (m ²)	552038-352010HK ¹ Price gr. A313 (m ²)	light sand-grey <input type="checkbox"/>
701-2039H ¹ Price gr. A361 (m ²)	702-2039H ¹ Price gr. A280 (m ²)	705-2039H Price gr. A211 (m ²)	710-2039H Price gr. A157 (m ²)	703-2039H Price gr. A157 (m ²)	552039-341550HK Price gr. A229 (m ²)	552039-352010HK Price gr. A289 (m ²)	medium sand-grey <input type="checkbox"/>
701-2040H ¹ Price gr. A361 (m ²)	702-2040H ¹ Price gr. A280 (m ²)	705-2040H Price gr. A211 (m ²)	710-2040H Price gr. A157 (m ²)	703-2040H ¹ Price gr. A187 (m ²)	552040-341550HK ¹ Price gr. A259 (m ²)	552040-352010HK ¹ Price gr. A313 (m ²)	dark sand-grey <input type="checkbox"/>

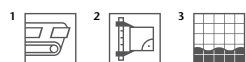

⁴ Production-related color deviations from the standard are possible.
⁵ Upon request, defined color nuances and mosaic pictures can also be supplied.
⁶ Overglazed edges proportionately in the sheet.
 Shower tub system, refer to series Plural non-slip, page 195/197



Floor/Wall Tiles

15 x 15 cm



20 x 20 cm



20 x 40 cm



25 x 50 cm²

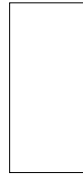

30 x 30 cm²



30 x 60 cm²



50 x 100 cm²

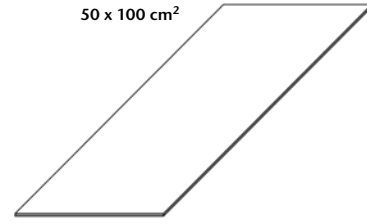

Model number	15 x 15 cm	20 x 20 cm	20 x 40 cm	25 x 50 cm ²	30 x 30 cm ²	30 x 60 cm ²	50 x 100 cm ²
Nom. dim. - cm/in	15 x 15 / 6 x 6	20 x 20 / 8 x 8	20 x 40 / 8 x 16	25 x 50 / 10 x 20	30 x 30 / 12 x 12	30 x 60 / 12 x 24	50 x 100 / 20 x 40
Work size	147 x 147 x 6.5 mm	197 x 197 x 6.5 mm	197 x 397 x 6.5 mm	247 x 497 x 8 mm	297 x 297 x 8 mm	297 x 597 x 8 mm	497 x 997 x 8 mm
Surface	smooth, for op-theat.	smooth, for op-theat.	smooth, for op-theat.	smooth, silky-matt	smooth, silky-matt	smooth, silky-matt	smooth, silky-matt
m ² - pieces	44.000	25.000	12.500	8.000	11.111	5.556	2.000
m ² - kg	13.816	13.875	14.100	17.040	17.222	17.413	18.080
Bundle - pieces	44	25	16	9	14	6	2
Bundle - m ²	1.000	1.000	1.280	1.125	1.260	1.080	1.000
Bundle - kg	13.816	13.875	18.048	19.170	21.700	18.804	18.080
Pallet - m ²	80.000	72.000	72.960	40.500	52.921	43.197	52.000
Pallet - kg	1,105.280	999.000	1,028.736	690.120	911.400	752.160	940.160
Product standard	Blb	Blb	Blb	Alb	Alb	Alb	Alb
Stress group	1	1	1	1	2	1	1
active yellow <input type="checkbox"/>	2 715-2017H ¹ Price gr. A166 (m ²)	720-2017H Price gr. A142 (m ²)	740-2017H ¹ Price gr. A173 (m ²)	552017-342550HK ³ Price gr. A181 (m ²)	730-2017H ^{1/3} Price gr. A217 (m ²)	760-2017H ^{1/3} Price gr. A217 (m ²)	552017-352050HK ^{1/3} Price gr. A259 (m ²)
light yellow <input type="checkbox"/>	4 715-2018H Price gr. A142 (m ²)	720-2018H Price gr. A142 (m ²)	740-2018H Price gr. A151 (m ²)	552018-342550HK Price gr. A181 (m ²)	730-2018H ¹ Price gr. A217 (m ²)	760-2018H ¹ Price gr. A217 (m ²)	552018-352050HK ¹ Price gr. A259 (m ²)
medium yellow <input type="checkbox"/>	3 715-2019H ¹ Price gr. A166 (m ²)	720-2019H ¹ Price gr. A166 (m ²)	740-2019H ¹ Price gr. A173 (m ²)	552019-342550HK Price gr. A181 (m ²)	730-2019H ¹ Price gr. A217 (m ²)	760-2019H ¹ Price gr. A217 (m ²)	552019-352050HK ¹ Price gr. A259 (m ²)
dark yellow <input type="checkbox"/>	2 715-2020H ¹ Price gr. A166 (m ²)	720-2020H ¹ Price gr. A166 (m ²)	740-2020H ¹ Price gr. A173 (m ²)	552020-342550HK ³ Price gr. A181 (m ²)	730-2020H ^{1/3} Price gr. A217 (m ²)	760-2020H ^{1/3} Price gr. A217 (m ²)	552020-352050HK ^{1/3} Price gr. A259 (m ²)
active ochre <input type="checkbox"/>	2 715-2021H ¹ Price gr. A166 (m ²)	720-2021H ¹ Price gr. A166 (m ²)	740-2021H ¹ Price gr. A173 (m ²)	552021-342550HK ³ Price gr. A181 (m ²)	730-2021H ^{1/3} Price gr. A217 (m ²)	760-2021H ^{1/3} Price gr. A217 (m ²)	552021-352050HK ^{1/3} Price gr. A259 (m ²)
light ochre <input type="checkbox"/>	4 715-2022H Price gr. A142 (m ²)	720-2022H Price gr. A142 (m ²)	740-2022H Price gr. A151 (m ²)	552022-342550HK Price gr. A181 (m ²)	730-2022H ¹ Price gr. A217 (m ²)	760-2022H ¹ Price gr. A217 (m ²)	552022-352050HK ¹ Price gr. A259 (m ²)
medium ochre <input type="checkbox"/>	3 715-2023H ¹ Price gr. A166 (m ²)	720-2023H ¹ Price gr. A166 (m ²)	740-2023H ¹ Price gr. A173 (m ²)	552023-342550HK Price gr. A181 (m ²)	730-2023H ¹ Price gr. A217 (m ²)	760-2023H ¹ Price gr. A217 (m ²)	552023-352050HK ¹ Price gr. A259 (m ²)
dark ochre <input type="checkbox"/>	2 715-2024H ¹ Price gr. A166 (m ²)	720-2024H ¹ Price gr. A166 (m ²)	740-2024H ¹ Price gr. A173 (m ²)	552024-342550HK Price gr. A181 (m ²)	730-2024H ¹ Price gr. A217 (m ²)	760-2024H ¹ Price gr. A217 (m ²)	552024-352050HK ¹ Price gr. A259 (m ²)
active salmon <input type="checkbox"/>	2 715-2025H ¹ Price gr. A166 (m ²)	720-2025H ¹ Price gr. A166 (m ²)	740-2025H ¹ Price gr. A173 (m ²)	552025-342550HK ³ Price gr. A181 (m ²)	730-2025H ^{1/3} Price gr. A217 (m ²)	760-2025H ^{1/3} Price gr. A217 (m ²)	552025-352050HK ^{1/3} Price gr. A259 (m ²)
light salmon <input type="checkbox"/>	4 715-2026H Price gr. A142 (m ²)	720-2026H ¹ Price gr. A166 (m ²)	740-2026H ¹ Price gr. A173 (m ²)	552026-342550HK Price gr. A181 (m ²)	730-2026H ¹ Price gr. A217 (m ²)	760-2026H ¹ Price gr. A217 (m ²)	552026-352050HK ¹ Price gr. A259 (m ²)
medium salmon <input type="checkbox"/>	3 715-2027H Price gr. A142 (m ²)	720-2027H Price gr. A142 (m ²)	740-2027H Price gr. A151 (m ²)	552027-342550HK Price gr. A181 (m ²)	730-2027H ¹ Price gr. A217 (m ²)	760-2027H ¹ Price gr. A217 (m ²)	552027-352050HK ¹ Price gr. A259 (m ²)
dark salmon <input type="checkbox"/>	2 715-2028H ¹ Price gr. A166 (m ²)	720-2028H ¹ Price gr. A166 (m ²)	740-2028H ¹ Price gr. A173 (m ²)	552028-342550HK Price gr. A181 (m ²)	730-2028H ¹ Price gr. A217 (m ²)	760-2028H ¹ Price gr. A217 (m ²)	552028-352050HK ¹ Price gr. A259 (m ²)
active oxide red <input type="checkbox"/>	2 715-2029H ¹ Price gr. A166 (m ²)	720-2029H ¹ Price gr. A166 (m ²)	740-2029H ¹ Price gr. A173 (m ²)	552029-342550HK Price gr. A181 (m ²)	730-2029H ¹ Price gr. A217 (m ²)	760-2029H ¹ Price gr. A217 (m ²)	552029-352050HK ¹ Price gr. A259 (m ²)
light oxide red <input type="checkbox"/>	4 715-2030H ¹ Price gr. A166 (m ²)	720-2030H ¹ Price gr. A166 (m ²)	740-2030H ¹ Price gr. A173 (m ²)	552030-342550HK Price gr. A181 (m ²)	730-2030H ¹ Price gr. A217 (m ²)	760-2030H ¹ Price gr. A217 (m ²)	552030-352050HK ¹ Price gr. A259 (m ²)
medium oxide red <input type="checkbox"/>	3 715-2031H Price gr. A142 (m ²)	720-2031H Price gr. A142 (m ²)	740-2031H Price gr. A151 (m ²)	552031-342550HK Price gr. A181 (m ²)	730-2031H ¹ Price gr. A217 (m ²)	760-2031H ¹ Price gr. A217 (m ²)	552031-352050HK ¹ Price gr. A259 (m ²)
dark oxide red <input type="checkbox"/>	2 715-2032H ¹ Price gr. A166 (m ²)	720-2032H ¹ Price gr. A166 (m ²)	740-2032H ¹ Price gr. A173 (m ²)	552032-342550HK Price gr. A181 (m ²)	730-2032H ¹ Price gr. A217 (m ²)	760-2032H ¹ Price gr. A217 (m ²)	552032-352050HK ¹ Price gr. A259 (m ²)
active stone grey <input type="checkbox"/>	2 715-2033H ¹ Price gr. A166 (m ²)	720-2033H ¹ Price gr. A166 (m ²)	740-2033H ¹ Price gr. A173 (m ²)	552033-342550HK Price gr. A181 (m ²)	730-2033H ¹ Price gr. A217 (m ²)	760-2033H ¹ Price gr. A217 (m ²)	552033-352050HK ¹ Price gr. A259 (m ²)
light stone grey <input type="checkbox"/>	4 715-2034H ¹ Price gr. A166 (m ²)	720-2034H ¹ Price gr. A166 (m ²)	740-2034H ¹ Price gr. A173 (m ²)	552034-342550HK Price gr. A181 (m ²)	730-2034H ¹ Price gr. A217 (m ²)	760-2034H ¹ Price gr. A217 (m ²)	552034-352050HK ¹ Price gr. A259 (m ²)
medium stone grey <input type="checkbox"/>	3 715-2035H ¹ Price gr. A166 (m ²)	720-2035H ¹ Price gr. A166 (m ²)	740-2035H ¹ Price gr. A173 (m ²)	552035-342550HK Price gr. A181 (m ²)	730-2035H ¹ Price gr. A187 (m ²)	760-2035H ¹ Price gr. A187 (m ²)	552035-352050HK Price gr. A229 (m ²)
dark stone grey <input type="checkbox"/>	2 715-2036H Price gr. A142 (m ²)	720-2036H Price gr. A142 (m ²)	740-2036H Price gr. A151 (m ²)	552036-342550HK Price gr. A181 (m ²)	730-2036H ¹ Price gr. A217 (m ²)	760-2036H ¹ Price gr. A217 (m ²)	552036-352050HK ¹ Price gr. A259 (m ²)
active sand-grey <input type="checkbox"/>	2 715-2037H ¹ Price gr. A166 (m ²)	720-2037H ¹ Price gr. A166 (m ²)	740-2037H ¹ Price gr. A187 (m ²)	552037-342550HK Price gr. A181 (m ²)	730-2037H ¹ Price gr. A217 (m ²)	760-2037H ¹ Price gr. A217 (m ²)	552037-352050HK ¹ Price gr. A259 (m ²)
light sand-grey <input type="checkbox"/>	4 715-2038H Price gr. A142 (m ²)	720-2038H Price gr. A142 (m ²)	740-2038H Price gr. A151 (m ²)	552038-342550HK Price gr. A181 (m ²)	730-2038H ¹ Price gr. A217 (m ²)	760-2038H ¹ Price gr. A217 (m ²)	552038-352050HK ¹ Price gr. A259 (m ²)
medium sand-grey <input type="checkbox"/>	3 715-2039H Price gr. A142 (m ²)	720-2039H Price gr. A142 (m ²)	740-2039H Price gr. A151 (m ²)	552039-342550HK Price gr. A181 (m ²)	730-2039H Price gr. A187 (m ²)	760-2039H Price gr. A187 (m ²)	552039-352050HK Price gr. A229 (m ²)
dark sand-grey <input type="checkbox"/>	2 715-2040H Price gr. A142 (m ²)	720-2040H Price gr. A142 (m ²)	740-2040H ¹ Price gr. A187 (m ²)	552040-342550HK Price gr. A181 (m ²)	730-2040H ¹ Price gr. A217 (m ²)	760-2040H ¹ Price gr. A217 (m ²)	552040-352050HK ¹ Price gr. A259 (m ²)



³ Production-related color deviations from the standard are possible.

Mosaic

10 x 10 cm^{1/2}



Sheet: 297 x 297 mm



						10 x 10 / 4 x 4	Nom. dim. - cm/in
						97 x 97 x 6.5 mm	Work size
						smooth, for op-theat.	Surface
						11 sheets	m ² - pieces
						13.101	m ² - kg
						11 sheets	Bundle - pieces
						1.000	Bundle - kg
						13.101	Bundle - m ²
						64.000	Pallet - m ²
						838.464	Pallet - kg
						Bib	Product standard
						1	Stress group
						710-2504H	3
						Price gr. A196 (m ²)	deep anthracite <input type="checkbox"/>
						710-2508H	3
						Price gr. A196 (m ²)	deep blue <input type="checkbox"/>
						710-2512H	3
						Price gr. A196 (m ²)	deep green <input type="checkbox"/>
						710-2516H	4
						Price gr. A196 (m ²)	deep yellow <input type="checkbox"/>
						710-2520H	4
						Price gr. A196 (m ²)	deep orange <input type="checkbox"/>
						710-2524H	3
						Price gr. A196 (m ²)	deep red <input type="checkbox"/>

¹ Overglazed edges proportionately in the sheet.

² Upon request, defined color nuances and mosaic pictures can also be supplied.

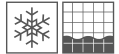

Cove Skirting¹ Internal Corner for Cove Skirting¹ External Corner for Cove Skirting¹

10 x 10 cm



Nom. dim. - cm/in	10 x 10 / 4 x 4	100 x 18 x 6.5 mm	100 x 18 x 6.5 mm			
Work size	100 x 97 x 6.5 mm	100 x 18 x 6.5 mm	100 x 18 x 6.5 mm			
Surface	smooth, silky-matt	smooth, silky-matt	smooth, silky-matt			
m - pieces	10.000					
m/pce. - kg	1.500/m	0.030/pieces	0.030/pieces			
Bundle - pieces	40	40	30			
Bundle - m	4.000					
Bundle - kg	6.000					
Pallet - m						
Pallet - kg						
Product standard	Bib	Bib	Bib			
neutral 10 (active white) <input type="checkbox"/>	4 763-2120H Price gr. A416 (pce.)	759-2120H Price gr. A430 (pce.)	761-2120H Price gr. A430 (pce.)			
neutral 9 (white-grey) <input type="checkbox"/>	4	759-2119H Price gr. A430 (pce.)	761-2119H Price gr. A430 (pce.)			
neutral 8 (light-grey) <input type="checkbox"/>	4 763-2118H Price gr. A416 (pce.)	759-2118H Price gr. A430 (pce.)	761-2118H Price gr. A430 (pce.)			
neutral 7 (pebble grey) <input type="checkbox"/>	4	759-2117H Price gr. A430 (pce.)	761-2117H Price gr. A430 (pce.)			
neutral 5 (basalt grey) <input type="checkbox"/>	3 763-2115H Price gr. A416 (pce.)	759-2115H Price gr. A430 (pce.)	761-2115H Price gr. A430 (pce.)			
neutral 3 (asphalt black) <input type="checkbox"/>	3	759-2113H Price gr. A430 (pce.)	761-2113H Price gr. A430 (pce.)			
neutral 1 (deep black) <input type="checkbox"/>	1 763-2111H Price gr. A416 (pce.)	759-2111H Price gr. A430 (pce.)	761-2111H Price gr. A430 (pce.)			
active azure <input type="checkbox"/>	2	759-2001H Price gr. A430 (pce.)	761-2001H Price gr. A430 (pce.)			
light azure <input type="checkbox"/>	4	759-2002H Price gr. A430 (pce.)	761-2002H Price gr. A430 (pce.)			
medium azure <input type="checkbox"/>	3 763-2003H Price gr. A416 (pce.)	759-2003H Price gr. A430 (pce.)	761-2003H Price gr. A430 (pce.)			
dark azure <input type="checkbox"/>	2	759-2004H Price gr. A430 (pce.)	761-2004H Price gr. A430 (pce.)			
light blue <input type="checkbox"/>	4	759-2006H Price gr. A430 (pce.)	761-2006H Price gr. A430 (pce.)			
medium blue <input type="checkbox"/>	3	759-2007H Price gr. A430 (pce.)	761-2007H Price gr. A430 (pce.)			
dark blue <input type="checkbox"/>	2	759-2008H Price gr. A430 (pce.)	761-2008H Price gr. A430 (pce.)			
medium turquoise <input type="checkbox"/>	3	759-2011H Price gr. A430 (pce.)	761-2011H Price gr. A430 (pce.)			
medium green <input type="checkbox"/>	3	759-2015H Price gr. A430 (pce.)	761-2015H Price gr. A430 (pce.)			
dark green <input type="checkbox"/>	2	759-2016H Price gr. A430 (pce.)	761-2016H Price gr. A430 (pce.)			
medium yellow <input type="checkbox"/>	3	759-2019H Price gr. A430 (pce.)	761-2019H Price gr. A430 (pce.)			
medium ochre <input type="checkbox"/>	3	759-2023H Price gr. A430 (pce.)	761-2023H Price gr. A430 (pce.)			
medium salmon <input type="checkbox"/>	3	759-2027H Price gr. A430 (pce.)	761-2027H Price gr. A430 (pce.)			
medium oxide red <input type="checkbox"/>	3	759-2031H Price gr. A430 (pce.)	761-2031H Price gr. A430 (pce.)			
light stone grey <input type="checkbox"/>	4 763-2034H Price gr. A416 (pce.)	759-2034H Price gr. A430 (pce.)	761-2034H Price gr. A430 (pce.)			
dark stone grey <input type="checkbox"/>	2 763-2036H Price gr. A416 (pce.)	759-2036H Price gr. A430 (pce.)	761-2036H Price gr. A430 (pce.)			
active sand-grey <input type="checkbox"/>	2 763-2037H Price gr. A416 (pce.)	759-2037H Price gr. A430 (pce.)	761-2037H Price gr. A430 (pce.)			
dark sand-grey <input type="checkbox"/>	2 763-2040H Price gr. A416 (pce.)	759-2040H Price gr. A430 (pce.)	761-2040H Price gr. A430 (pce.)			

¹ For details, refer to page 294 and the following.

Shower tub system, refer to series Plural non-slip, page 195/197





Explorer Hotel, St. Johann, Austria / Architect: Camp Innenarchitektur / Photo: Roland Reuter, Absam









2120/2121
neutral 10 (active white)



2119
neutral 9 (white-grey)



2118
neutral 8 (light-grey)



2117
neutral 7 (pebble-grey)



2116
neutral 6 (pearl grey)



2115
neutral 5 (basalt-grey)



2114
neutral 4 (graphite-black)



2113
neutral 3 (asphalt black)



2112
neutral 2 (anthracite)



2111
neutral 1 (deep black)



2004
dark azure



2008
dark blue



2012
dark turquoise



2016
dark green



2020
dark yellow



2024
dark ochre



2028
dark salmon



2032
dark oxide red



2036
dark stone grey



2040
dark sand grey



2003
medium azure



2007
medium blue



2011
medium turquoise



2015
medium green



2019
medium yellow



2023
medium ochre



2027
medium salmon



2031
medium oxide red



2035
medium stone grey



2039
medium sand grey



2002
light azure

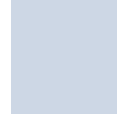

2006
light blue



2010
light turquoise



2014
light green



2018
light yellow



2022
light ochre



2026
light salmon



2030
light oxide red



2034
light stone grey



2038
light sand grey



2001
active azure



2005
active blue



2009
active turquoise



2013
active green



2017
active yellow



2021
active ochre



2025
active salmon



2029
active oxide red



2033
active stone grey



2037
active sand grey

Mosaic 2.5 x 2.5 cm, 1 x 1 in

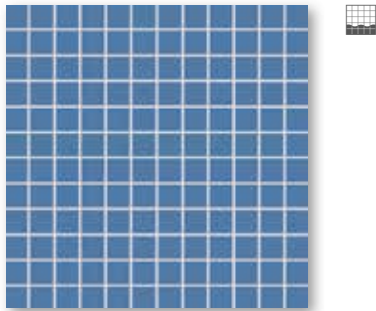

Mosaic sheet 30 x 30 cm, 12 x 12 in, smooth, R10/B



Cove skirting
10 x 10 cm, 4 x 4 in
smooth, R10/B



Shower tub system Corner
10 x 10 cm, 4 x 4 in
smooth, R10/B



Internal
corner
smooth



External
corner
smooth



Shower tub system Strip,
10 x 10 cm, 4 x 4 in
smooth, R10/B

Mosaic 5 x 5 cm, 2 x 2 in

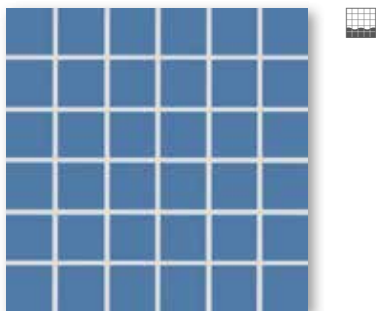

Mosaic sheet 30 x 30 cm, 12 x 12 in, smooth, R10/B

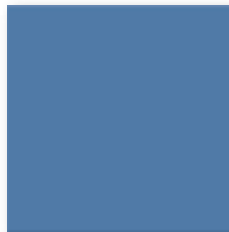

Floor tile 20 x 20 cm, 8 x 8 in
smooth, R10/B

Mosaic 10 x 10 cm, 4 x 4 in

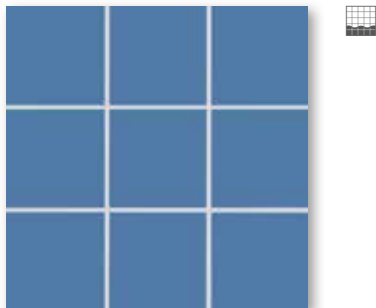

Mosaic sheet 30 x 30 cm, 12 x 12 in, smooth, R10/B



Floor tile 30 x 60 cm, 12 x 24 in
smooth, R10/B



Mosaics glued thermoplastically on back of AGROB BUCHTAL can be used not only in dry zones but also without any problems in underwater areas (e.g. swimming pools/whirlpools) as well as in permanently wet areas (e.g. pool surrounds/showers).

Do you already know our Mosaic Designer at our website www.agrob-buchtal.com?

There, you will have the possibility of designing your individual color gradients, mosaic compositions and the laying of pictures.

Mosaic^{2/4}

2.5 x 2.5 cm

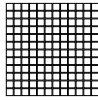

5 x 5 cm

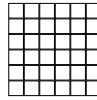

10 x 10 cm

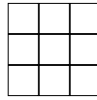

Wall/Floor Tiles

20 x 20 cm



30 x 60 cm^{1/3}



Sheet: 297 x 297 mm

Sheet: 297 x 297 mm

Sheet: 297 x 297 mm

Nom. dim. - cm/in	2.5 x 2.5 / 1 x 1	5 x 5 / 2 x 2	10 x 10 / 4 x 4	20 x 20 / 8 x 8	30 x 60 / 12 x 24		
Work size	23 x 23 x 6.5 mm	47 x 47 x 6.5 mm	97 x 97 x 6.5 mm	197 x 197 x 6.5 mm	297 x 597 x 8 mm		
Surface	smooth, matt	smooth, matt	smooth, matt	smooth, matt	smooth, matt		
m ² - pieces	11 sheets	11 sheets	11 sheets	11 sheets	5.556		
m ² - kg	12.100	12.331	13.101	13.875	17.413		
Bundle - pieces	11 sheets	11 sheets	11 sheets	25	6		
Bundle - m ²	1.000	1.000	1.000	1.000	1.080		
Bundle - kg	12.100	12.331	13.101	13.875	18.804		
Pallet - m ²	48.000	64.000	64.000	72.000	43.197		
Pallet - kg	580.800	789.184	838.464	999.000	752.160		
Product standard	Blb	Blb	Blb	Blb	Alb		
Slip resistance	R10/B	R10/B	R10/B	R10/B	R10/B		
Stress group	1	1	1	1	2		
neutral 10 (active white)	4 902-2120H Price gr. A238 (m ²)	905-2120H Price gr. A205 (m ²)	910-2120H Price gr. A166 (m ²)	920-2120H Price gr. A148 (m ²)	980-2120H Price gr. A181 (m ²)		
neutral 9 (white-grey)	4 902-2119H¹ Price gr. A289 (m ²)	905-2119H¹ Price gr. A250 (m ²)	910-2119H Price gr. A190 (m ²)	920-2119H¹ Price gr. A190 (m ²)			
neutral 8 (light-grey)	4 902-2118H Price gr. A238 (m ²)	905-2118H Price gr. A205 (m ²)	910-2118H Price gr. A166 (m ²)	920-2118H Price gr. A148 (m ²)	980-2118H Price gr. A205 (m ²)		
neutral 7 (pebble grey)	4 902-2117H¹ Price gr. A289 (m ²)	905-2117H¹ Price gr. A256 (m ²)	910-2117H Price gr. A190 (m ²)	920-2117H¹ Price gr. A190 (m ²)			
neutral 6 (pearl grey)	3 902-2116H¹ Price gr. A289 (m ²)	905-2116H¹ Price gr. A256 (m ²)	910-2116H¹ Price gr. A223 (m ²)	920-2116H¹ Price gr. A190 (m ²)			
neutral 5 (basalt grey)	3 902-2115H¹ Price gr. A289 (m ²)	905-2115H¹ Price gr. A256 (m ²)	910-2115H Price gr. A190 (m ²)	920-2115H Price gr. A166 (m ²)			
neutral 4 (graphite black)	3 902-2114H¹ Price gr. A289 (m ²)	905-2114H¹ Price gr. A256 (m ²)	910-2114H Price gr. A190 (m ²)	920-2114H Price gr. A166 (m ²)			
neutral 3 (asphalt black)	3 902-2113H¹ Price gr. A289 (m ²)	905-2113H¹ Price gr. A256 (m ²)	910-2113H Price gr. A190 (m ²)	920-2113H¹ Price gr. A190 (m ²)			
neutral 2 (anthracite)	2 902-2112H¹ Price gr. A289 (m ²)	905-2112H¹ Price gr. A256 (m ²)	910-2112H Price gr. A190 (m ²)	920-2112H Price gr. A166 (m ²)			
neutral 1 (deep black)	1 902-2111H Price gr. A259 (m ²)	905-2111H Price gr. A229 (m ²)	910-2111H Price gr. A190 (m ²)	920-2111H Price gr. A166 (m ²)	980-2111H Price gr. A181 (m ²)		
active azure	2 902-2001H¹ Price gr. A289 (m ²)	905-2001H¹ Price gr. A256 (m ²)	910-2001H Price gr. A190 (m ²)	920-2001H¹ Price gr. A190 (m ²)			
light azure	4 902-2002H¹ Price gr. A289 (m ²)	905-2002H¹ Price gr. A256 (m ²)	910-2002H Price gr. A190 (m ²)	920-2002H¹ Price gr. A190 (m ²)			
medium azure	3 902-2003H Price gr. A259 (m ²)	905-2003H Price gr. A229 (m ²)	910-2003H Price gr. A190 (m ²)	920-2003H Price gr. A166 (m ²)	980-2003H Price gr. A205 (m ²)		
dark azure	2 902-2004H Price gr. A259 (m ²)	905-2004H¹ Price gr. A256 (m ²)	910-2004H Price gr. A190 (m ²)	920-2004H Price gr. A166 (m ²)			
active blue	2 902-2005H¹ Price gr. A289 (m ²)	905-2005H¹ Price gr. A256 (m ²)	910-2005H¹ Price gr. A223 (m ²)	920-2005H¹ Price gr. A190 (m ²)			
light blue	4 902-2006H¹ Price gr. A289 (m ²)	905-2006H¹ Price gr. A256 (m ²)	910-2006H Price gr. A190 (m ²)	920-2006H¹ Price gr. A190 (m ²)			
medium blue	3 902-2007H¹ Price gr. A289 (m ²)	905-2007H¹ Price gr. A256 (m ²)	910-2007H Price gr. A190 (m ²)	920-2007H Price gr. A166 (m ²)	980-2007H Price gr. A205 (m ²)		
dark blue	2 902-2008H Price gr. A259 (m ²)	905-2008H Price gr. A229 (m ²)	910-2008H Price gr. A190 (m ²)	920-2008H Price gr. A166 (m ²)			
active turquoise	2 902-2009H¹ Price gr. A289 (m ²)	905-2009H¹ Price gr. A256 (m ²)	910-2009H¹ Price gr. A223 (m ²)	920-2009H¹ Price gr. A190 (m ²)			
light turquoise	4 902-2010H¹ Price gr. A289 (m ²)	905-2010H¹ Price gr. A256 (m ²)	910-2010H¹ Price gr. A223 (m ²)	920-2010H¹ Price gr. A190 (m ²)			
medium turquoise	3 902-2011H¹ Price gr. A289 (m ²)	905-2011H¹ Price gr. A256 (m ²)	910-2011H Price gr. A190 (m ²)	920-2011H Price gr. A166 (m ²)	980-2011H Price gr. A205 (m ²)		
dark turquoise	2 902-2012H¹ Price gr. A289 (m ²)	905-2012H¹ Price gr. A256 (m ²)	910-2012H¹ Price gr. A223 (m ²)	920-2012H¹ Price gr. A190 (m ²)			
active green	2 902-2013H¹ Price gr. A289 (m ²)	905-2013H¹ Price gr. A256 (m ²)	910-2013H¹ Price gr. A223 (m ²)	920-2013H¹ Price gr. A190 (m ²)			
light green	4 902-2014H¹ Price gr. A289 (m ²)	905-2014H Price gr. A229 (m ²)	910-2014H¹ Price gr. A223 (m ²)	920-2014H¹ Price gr. A190 (m ²)			
medium green	3 902-2015H¹ Price gr. A289 (m ²)	905-2015H¹ Price gr. A256 (m ²)	910-2015H Price gr. A190 (m ²)	920-2015H Price gr. A166 (m ²)	980-2015H Price gr. A205 (m ²)		
dark green	2 902-2016H¹ Price gr. A289 (m ²)	905-2016H¹ Price gr. A256 (m ²)	910-2016H Price gr. A190 (m ²)	920-2016H Price gr. A166 (m ²)			



1



2



3



⁴ Upon request, defined color nuances and mosaic pictures can also be supplied.

Cove Skirting¹

Internal Corner for Cove Skirting¹

External Corner for Cove Skirting¹

Shower Tub System²

10 x 10 cm



10 x 10 cm



10 x 10 cm



					Strip		Corner			
		10 x 10 / 4 x 4	100 x 18 x 6.5 mm	100 x 18 x 6.5 mm	100 x 18 x 6.5 mm	10 x 10 / 4 x 4	10 x 10 / 4 x 4	10 x 10 / 4 x 4		
		smooth, matt	smooth, matt	smooth, matt	smooth, matt	smooth, matt	smooth, matt	smooth, matt		
		10.000				10.000				
		1.500/m	0.030/pieces	0.030/pieces	1.700/m	0.170/pieces				
		40	40	30	16	4				
		4.000			1.600					
		6.000			2.720	0.680				
		Bib	Bib	Bib	Bib	Bib				
		R10/B			R10/B	R10/B				
		764-2120H	759-2120H	761-2120H	785-2120H	786-2120H				
		Price gr. A418 (pce.)	Price gr. A430 (pce.)	Price gr. A430 (pce.)	Price gr. A428 (pce.)	Price gr. A455 (pce.)				
		764-2119H	759-2119H	761-2119H	785-2119H	786-2119H				
		Price gr. A418 (pce.)	Price gr. A430 (pce.)	Price gr. A430 (pce.)	Price gr. A428 (pce.)	Price gr. A455 (pce.)				
		764-2118H	759-2118H	761-2118H	785-2118H	786-2118H				
		Price gr. A418 (pce.)	Price gr. A430 (pce.)	Price gr. A430 (pce.)	Price gr. A428 (pce.)	Price gr. A455 (pce.)				
		764-2117H	759-2117H	761-2117H	785-2117H	786-2117H				
		Price gr. A418 (pce.)	Price gr. A430 (pce.)	Price gr. A430 (pce.)	Price gr. A428 (pce.)	Price gr. A455 (pce.)				
		764-2115H	759-2115H	761-2115H	785-2115H	786-2115H				
		Price gr. A418 (pce.)	Price gr. A430 (pce.)	Price gr. A430 (pce.)	Price gr. A428 (pce.)	Price gr. A455 (pce.)				
		764-2113H	759-2113H	761-2113H	785-2113H	786-2113H				
		Price gr. A418 (pce.)	Price gr. A430 (pce.)	Price gr. A430 (pce.)	Price gr. A428 (pce.)	Price gr. A455 (pce.)				
		764-2111H	759-2111H	761-2111H	785-2111H	786-2111H				
		Price gr. A418 (pce.)	Price gr. A430 (pce.)	Price gr. A430 (pce.)	Price gr. A428 (pce.)	Price gr. A455 (pce.)				
		764-2001H	759-2001H	761-2001H	785-2001H	786-2001H				
		Price gr. A418 (pce.)	Price gr. A430 (pce.)	Price gr. A430 (pce.)	Price gr. A428 (pce.)	Price gr. A455 (pce.)				
		764-2002H	759-2002H	761-2002H	785-2002H	786-2002H				
		Price gr. A418 (pce.)	Price gr. A430 (pce.)	Price gr. A430 (pce.)	Price gr. A428 (pce.)	Price gr. A455 (pce.)				
		764-2003H	759-2003H	761-2003H	785-2003H	786-2003H				
		Price gr. A418 (pce.)	Price gr. A430 (pce.)	Price gr. A430 (pce.)	Price gr. A428 (pce.)	Price gr. A455 (pce.)				
		764-2004H	759-2004H	761-2004H	785-2004H	786-2004H				
		Price gr. A418 (pce.)	Price gr. A430 (pce.)	Price gr. A430 (pce.)	Price gr. A428 (pce.)	Price gr. A455 (pce.)				
		764-2006H	759-2006H	761-2006H	785-2006H	786-2006H				
		Price gr. A418 (pce.)	Price gr. A430 (pce.)	Price gr. A430 (pce.)	Price gr. A428 (pce.)	Price gr. A455 (pce.)				
		764-2007H	759-2007H	761-2007H	785-2007H	786-2007H				
		Price gr. A418 (pce.)	Price gr. A430 (pce.)	Price gr. A430 (pce.)	Price gr. A428 (pce.)	Price gr. A455 (pce.)				
		764-2008H	759-2008H	761-2008H	785-2008H	786-2008H				
		Price gr. A418 (pce.)	Price gr. A430 (pce.)	Price gr. A430 (pce.)	Price gr. A428 (pce.)	Price gr. A455 (pce.)				
		764-2011H	759-2011H	761-2011H	785-2011H	786-2011H				
		Price gr. A418 (pce.)	Price gr. A430 (pce.)	Price gr. A430 (pce.)	Price gr. A428 (pce.)	Price gr. A455 (pce.)				
		764-2015H	759-2015H	761-2015H	785-2015H	786-2015H				
		Price gr. A418 (pce.)	Price gr. A430 (pce.)	Price gr. A430 (pce.)	Price gr. A428 (pce.)	Price gr. A455 (pce.)				
		764-2016H	759-2016H	761-2016H	785-2016H	786-2016H				
		Price gr. A418 (pce.)	Price gr. A430 (pce.)	Price gr. A430 (pce.)	Price gr. A428 (pce.)	Price gr. A455 (pce.)				

¹ For details, refer to page 294 and the following

² For details, refer to page 292



Mosaic^{2/4}

Wall/Floor Tiles

2.5 x 2.5 cm

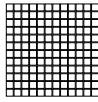

5 x 5 cm

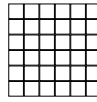

10 x 10 cm

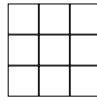

20 x 20 cm



30 x 60 cm^{1/3}



Sheet: 297 x 297 mm

Sheet: 297 x 297 mm

Sheet: 297 x 297 mm

Nom. dim. - cm/in	2.5 x 2.5 / 1 x 1	5 x 5 / 2 x 2	10 x 10 / 4 x 4	20 x 20 / 8 x 8	30 x 60 / 12 x 24		
Work size	23 x 23 x 6.5 mm	47 x 47 x 6.5 mm	97 x 97 x 6.5 mm	197 x 197 x 6.5 mm	297 x 597 x 8 mm		
Surface	smooth, matt	smooth, matt	smooth, matt	smooth, matt	smooth, matt		
m ² - pieces	11 sheets	11 sheets	11 sheets	25.000	5.556		
m ² - kg	12.100	12.331	13.101	13.875	17.413		
Bundle - pieces	11 sheets	11 sheets	11 sheets	25	6		
Bundle - m ²	1.000	1.000	1.000	1.000	1.080		
Bundle - kg	12.100	12.331	13.101	13.875	18.804		
Pallet - m ²	48.000	64.000	64.000	72.000	43.197		
Pallet - kg	580.800	789.184	838.464	999.000	752.160		
Product standard	BI _b	BI _b	BI _b	BI _b	A1 _b		
Slip resistance	R10/B	R10/B	R10/B	R10/B	R10/B		
Stress group	1	1	1	1	2		
active yellow <input type="checkbox"/>	2 902-2017H ¹ Price gr. A289 (m ²)	905-2017H ¹ Price gr. A256 (m ²)	910-2017H ¹ Price gr. A223 (m ²)	920-2017H ¹ Price gr. A190 (m ²)			
light yellow <input type="checkbox"/>	4 902-2018H ¹ Price gr. A289 (m ²)	905-2018H ¹ Price gr. A256 (m ²)	910-2018H ¹ Price gr. A223 (m ²)	920-2018H ¹ Price gr. A190 (m ²)			
medium yellow <input type="checkbox"/>	3 902-2019H ¹ Price gr. A289 (m ²)	905-2019H ¹ Price gr. A256 (m ²)	910-2019H ¹ Price gr. A190 (m ²)	920-2019H ¹ Price gr. A166 (m ²)	980-2019H Price gr. A205 (m ²)		
dark yellow <input type="checkbox"/>	2 902-2020H ¹ Price gr. A289 (m ²)	905-2020H ¹ Price gr. A256 (m ²)	910-2020H ¹ Price gr. A223 (m ²)	920-2020H ¹ Price gr. A190 (m ²)			
active ochre <input type="checkbox"/>	2 902-2021H ¹ Price gr. A289 (m ²)	905-2021H ¹ Price gr. A256 (m ²)	910-2021H ¹ Price gr. A223 (m ²)	920-2021H ¹ Price gr. A190 (m ²)			
light ochre <input type="checkbox"/>	4 902-2022H ¹ Price gr. A289 (m ²)	905-2022H ¹ Price gr. A256 (m ²)	910-2022H ¹ Price gr. A190 (m ²)	920-2022H ¹ Price gr. A190 (m ²)			
medium ochre <input type="checkbox"/>	3 902-2023H ¹ Price gr. A289 (m ²)	905-2023H ¹ Price gr. A256 (m ²)	910-2023H ¹ Price gr. A190 (m ²)	920-2023H ¹ Price gr. A166 (m ²)	980-2023H Price gr. A205 (m ²)		
dark ochre <input type="checkbox"/>	2 902-2024H ¹ Price gr. A289 (m ²)	905-2024H ¹ Price gr. A256 (m ²)	910-2024H ¹ Price gr. A223 (m ²)	920-2024H ¹ Price gr. A190 (m ²)			
active salmon <input type="checkbox"/>	2 902-2025H ¹ Price gr. A289 (m ²)	905-2025H ¹ Price gr. A256 (m ²)	910-2025H ¹ Price gr. A223 (m ²)	920-2025H ¹ Price gr. A190 (m ²)			
light salmon <input type="checkbox"/>	4 902-2026H ¹ Price gr. A289 (m ²)	905-2026H ¹ Price gr. A256 (m ²)	910-2026H ¹ Price gr. A223 (m ²)	920-2026H ¹ Price gr. A190 (m ²)			
medium salmon <input type="checkbox"/>	3 902-2027H ¹ Price gr. A289 (m ²)	905-2027H ¹ Price gr. A229 (m ²)	910-2027H ¹ Price gr. A190 (m ²)	920-2027H ¹ Price gr. A166 (m ²)	980-2027H Price gr. A205 (m ²)		
dark salmon <input type="checkbox"/>	2 902-2028H ¹ Price gr. A289 (m ²)	905-2028H ¹ Price gr. A256 (m ²)	910-2028H ¹ Price gr. A223 (m ²)	920-2028H ¹ Price gr. A166 (m ²)			
active oxide red <input type="checkbox"/>	2 902-2029H ¹ Price gr. A289 (m ²)	905-2029H ¹ Price gr. A229 (m ²)	910-2029H ¹ Price gr. A223 (m ²)	920-2029H ¹ Price gr. A190 (m ²)			
light oxide red <input type="checkbox"/>	4 902-2030H ¹ Price gr. A289 (m ²)	905-2030H ¹ Price gr. A256 (m ²)	910-2030H ¹ Price gr. A223 (m ²)	920-2030H ¹ Price gr. A190 (m ²)			
medium oxide red <input type="checkbox"/>	3 902-2031H ¹ Price gr. A289 (m ²)	905-2031H ¹ Price gr. A256 (m ²)	910-2031H ¹ Price gr. A190 (m ²)	920-2031H ¹ Price gr. A166 (m ²)	980-2031H Price gr. A205 (m ²)		
dark oxide red <input type="checkbox"/>	2 902-2032H ¹ Price gr. A289 (m ²)	905-2032H ¹ Price gr. A256 (m ²)	910-2032H ¹ Price gr. A223 (m ²)	920-2032H ¹ Price gr. A190 (m ²)			
active stone grey <input type="checkbox"/>	2 902-2033H ¹ Price gr. A289 (m ²)	905-2033H ¹ Price gr. A256 (m ²)	910-2033H ¹ Price gr. A190 (m ²)	920-2033H ¹ Price gr. A190 (m ²)			
light stone grey <input type="checkbox"/>	4 902-2034H ¹ Price gr. A289 (m ²)	905-2034H ¹ Price gr. A256 (m ²)	910-2034H ¹ Price gr. A190 (m ²)	920-2034H ¹ Price gr. A190 (m ²)			
medium stone grey <input type="checkbox"/>	3 902-2035H ¹ Price gr. A289 (m ²)	905-2035H ¹ Price gr. A256 (m ²)	910-2035H ¹ Price gr. A190 (m ²)	920-2035H ¹ Price gr. A190 (m ²)			
dark stone grey <input type="checkbox"/>	2 902-2036H ¹ Price gr. A259 (m ²)	905-2036H ¹ Price gr. A229 (m ²)	910-2036H ¹ Price gr. A190 (m ²)	920-2036H ¹ Price gr. A166 (m ²)			
active sand-grey <input type="checkbox"/>	2 902-2037H ¹ Price gr. A289 (m ²)	905-2037H ¹ Price gr. A256 (m ²)	910-2037H ¹ Price gr. A190 (m ²)	920-2037H ¹ Price gr. A190 (m ²)			
light sand-grey <input type="checkbox"/>	4 902-2038H ¹ Price gr. A289 (m ²)	905-2038H ¹ Price gr. A229 (m ²)	910-2038H ¹ Price gr. A190 (m ²)	920-2038H ¹ Price gr. A166 (m ²)			
medium sand-grey <input type="checkbox"/>	3 902-2039H ¹ Price gr. A289 (m ²)	905-2039H ¹ Price gr. A229 (m ²)	910-2039H ¹ Price gr. A190 (m ²)	920-2039H ¹ Price gr. A166 (m ²)	980-2039H Price gr. A205 (m ²)		
dark sand-grey <input type="checkbox"/>	2 902-2040H ¹ Price gr. A259 (m ²)	905-2040H ¹ Price gr. A229 (m ²)	910-2040H ¹ Price gr. A190 (m ²)	920-2040H ¹ Price gr. A166 (m ²)			



⁴ Upon request, defined color nuances and mosaic pictures can also be supplied.

Cove Skirting¹ Internal Corner for Cove Skirting¹

External Corner for Cove Skirting¹

Shower Tub System²

10 x 10 cm



10 x 10 cm



10 x 10 cm



					Strip		Corner			
		10 x 10 / 4 x 4	100 x 18 x 6.5 mm	100 x 18 x 6.5 mm	100 x 18 x 6.5 mm	97 x 97 x 6.5 mm	97 x 97 x 6.5 mm	97 x 97 x 6.5 mm	Nom. dim. - cm/in	
		smooth, matt	smooth, matt	smooth, matt	smooth, matt	smooth, matt	smooth, matt	smooth, matt	Work size	
		10.000				10.000			Surface	
		1.500/m	0.030/pieces	0.030/pieces	1.700/m	0.170/pieces	0.170/pieces		m - pieces	
		40	40	30	16	4			m/pce. - kg	
		4.000			1.600				Bundle - pieces	
		6.000			2.720	0.680			Bundle - m	
									Pallet - m	
		Bib	Bib	Bib	Bib	Bib	Bib		Pallet - kg	
		R10/B			R10/B	R10/B			Product standard	
									Slip resistance	
									Stress group	
		764-2019H	759-2019H	761-2019H	785-2019H	786-2019H			3	medium yellow
		Price gr. A418 (pce.)	Price gr. A430 (pce.)	Price gr. A430 (pce.)	Price gr. A428 (pce.)	Price gr. A455 (pce.)				
		764-2023H	759-2023H	761-2023H	785-2023H	786-2023H			3	medium ochre
		Price gr. A418 (pce.)	Price gr. A430 (pce.)	Price gr. A430 (pce.)	Price gr. A428 (pce.)	Price gr. A455 (pce.)				
		764-2027H	759-2027H	761-2027H	785-2027H	786-2027H			3	medium salmon
		Price gr. A418 (pce.)	Price gr. A430 (pce.)	Price gr. A430 (pce.)	Price gr. A428 (pce.)	Price gr. A455 (pce.)				
		764-2031H	759-2031H	761-2031H	785-2031H	786-2031H			3	medium oxide red
		Price gr. A418 (pce.)	Price gr. A430 (pce.)	Price gr. A430 (pce.)	Price gr. A428 (pce.)	Price gr. A455 (pce.)				
		764-2034H	759-2034H	761-2034H	785-2034H	786-2034H			4	light stone grey
		Price gr. A418 (pce.)	Price gr. A430 (pce.)	Price gr. A430 (pce.)	Price gr. A428 (pce.)	Price gr. A455 (pce.)				
		764-2036H	759-2036H	761-2036H	785-2036H	786-2036H			2	dark stone grey
		Price gr. A418 (pce.)	Price gr. A430 (pce.)	Price gr. A430 (pce.)	Price gr. A428 (pce.)	Price gr. A455 (pce.)				
		764-2037H	759-2037H	761-2037H	785-2037H	786-2037H			2	active sand-grey
		Price gr. A418 (pce.)	Price gr. A430 (pce.)	Price gr. A430 (pce.)	Price gr. A428 (pce.)	Price gr. A455 (pce.)				
		764-2040H	759-2040H	761-2040H	785-2040H	786-2040H			2	dark sand-grey
		Price gr. A418 (pce.)	Price gr. A430 (pce.)	Price gr. A430 (pce.)	Price gr. A428 (pce.)	Price gr. A455 (pce.)				

¹ For details, refer to page 294 and the following

² For details, refer to page 292



Badepark in Berenbostel, Garbsen, Germany / Architect: Architekten Venneberg, Zech & Partner mbB, Hannover, Germany
Series: Plural unglazed / Photo: Jochen Stüber





200 PLURAL UNGLAZED
porcelain stoneware



R10/B R11/C



2008
dark blue



2040
dark sand grey



2016
dark green



2041
medium brown



2023
medium ochre



2042
medium grey



2033
active stone grey



2043
medium sand beige



2038
sandwhite



2111
neutral 1 (deep black)



2039
medium sand grey



2113
neutral 3 (asphalt black)

Mosaic 2.5 x 2.5 cm, 1 x 1 in

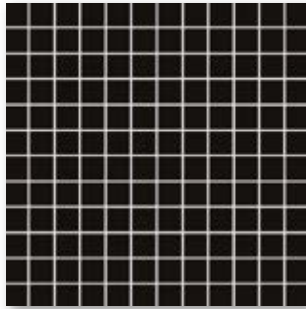

Mosaic sheet 30 x 30 cm, 12 x 12 in, smooth, R10/B



Floor tile 15 x 15 cm, 6 x 6 in, smooth, R10/B
Floor tile 15 x 15 cm, 6 x 6 in, relief, R11/C

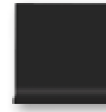

Cove skirting
10 x 10 cm, 4 x 4 in, smooth, R10/B



Shower tub system Corner
10 x 10 cm, 4 x 4 in, smooth, R10/B

Mosaic 5 x 5 cm, 2 x 2 in

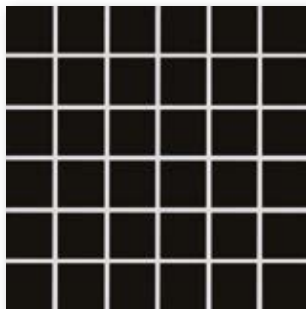

Mosaic sheet 30 x 30 cm, 12 x 12 in, smooth, R10/B



Floor tile 20 x 20 cm, 8 x 8 in, smooth, R10/B



Shower tub system Strip
10 x 10 cm, 4 x 4 in, smooth, R10/B

Mosaic 10 x 10 cm, 4 x 4 in

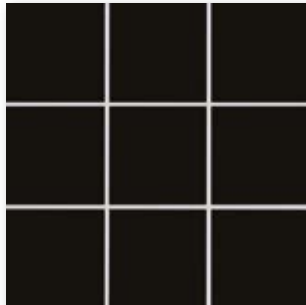

Mosaic sheet 30 x 30 cm, 12 x 12 in, smooth, R10/B
Mosaic sheet 30 x 30 cm, 12 x 12 in, relief, R11/C



Floor tile 30 x 60 cm, 12 x 24 in, smooth, R10/B



Mosaics glued thermoplastically on back of AGROB BUCHTAL can be used not only in dry zones but also without any problems in underwater areas (e.g. swimming pools/whirlpools) as well as in permanently wet areas (e.g. pool surrounds/showers).

Mosaic^{1/2}

Floor Tiles



protected

2.5 x 2.5 cm

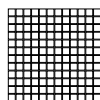

5 x 5 cm

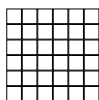

10 x 10 cm

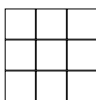

10 x 10 cm

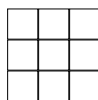

15 x 15 cm



15 x 15 cm



Sheet: 297 x 297 mm

Sheet: 297 x 297 mm

Sheet: 297 x 297 mm

Sheet: 297 x 297 mm

Nom. dim. - cm/in	2.5 x 2.5 / 1 x 1	5 x 5 / 2 x 2	10 x 10 / 4 x 4	10 x 10 / 4 x 4	15 x 15 / 6 x 6	15 x 15 / 6 x 6	
Work size	23 x 23 x 6.5 mm	47 x 47 x 6.5 mm	97 x 97 x 6.5 mm	97 x 97 x 6.5 mm	147 x 147 x 6.5 mm	147 x 147 x 6.5 mm	
Surface	smooth, matt	smooth, matt	smooth, matt	relief, matt	smooth, matt	relief, matt	
m ² - pieces	11 sheets	11 sheets	11 sheets	11 sheets	44.000	44.000	
m ² - kg	12.100	12.331	13.101	13.101	13.816	13.816	
Bundle - pieces	11 sheets	11 sheets	11 sheets	11 sheets	44	44	
Bundle - m ²	1.000	1.000	1.000	1.000	1.000	1.000	
Bundle - kg	12.100	12.331	13.101	13.101	13.816	13.816	
Pallet - m ²	48.000	64.000	64.000	64.000	80.000	80.000	
Pallet - kg	580.800	789.184	838.464	838.464	1,105.280	1,105.280	
Product standard	Bla	Bla	Bla	Bla	Bla	Bla	
Slip resistance	R10/B	R10/B	R10/B	R11/C	R10/B	R11/C	
Stress group	1	1	1	1	1	1	
neutral 3 (asphalt black) <input type="checkbox"/>	410-2113 Price gr. A199 (m ²)	610-2113 Price gr. A175 (m ²)	810-2113 Price gr. A136 (m ²)	811-2113 Price gr. A166 (m ²)	812-2113 Price gr. A127 (m ²)	813-2113 Price gr. A148 (m ²)	
neutral 1 (deep black) <input type="checkbox"/>	410-2111 Price gr. A199 (m ²)	610-2111 Price gr. A175 (m ²)	810-2111 Price gr. A136 (m ²)	811-2111 Price gr. A166 (m ²)	812-2111 Price gr. A127 (m ²)	813-2111 Price gr. A148 (m ²)	
dark blue <input type="checkbox"/>	410-2008 Price gr. A238 (m ²)	610-2008 Price gr. A211 (m ²)	810-2008 Price gr. A175 (m ²)				
dark green <input type="checkbox"/>		610-2016 Price gr. A211 (m ²)	810-2016 Price gr. A175 (m ²)				
medium ochre <input type="checkbox"/>	410-2023 Price gr. A238 (m ²)	610-2023 Price gr. A211 (m ²)	810-2023 Price gr. A175 (m ²)				
active stone grey <input type="checkbox"/>		610-2033 Price gr. A211 (m ²)	810-2033 Price gr. A175 (m ²)				
sand-white <input type="checkbox"/>	410-2038 Price gr. A199 (m ²)	610-2038 Price gr. A175 (m ²)	810-2038 Price gr. A136 (m ²)	811-2038 Price gr. A166 (m ²)	812-2038 Price gr. A127 (m ²)	813-2038 Price gr. A148 (m ²)	
medium sand-grey <input type="checkbox"/>	410-2039 Price gr. A199 (m ²)	610-2039 Price gr. A175 (m ²)	810-2039 Price gr. A136 (m ²)				
dark sand-grey <input type="checkbox"/>	410-2040 Price gr. A199 (m ²)	610-2040 Price gr. A175 (m ²)	810-2040 Price gr. A136 (m ²)				
medium brown <input type="checkbox"/>	410-2041 Price gr. A238 (m ²)	610-2041 Price gr. A211 (m ²)	810-2041 Price gr. A175 (m ²)				
medium grey <input type="checkbox"/>	410-2042 Price gr. A238 (m ²)	610-2042 Price gr. A211 (m ²)	810-2042 Price gr. A175 (m ²)	811-2042 Price gr. A181 (m ²)	812-2042 Price gr. A154 (m ²)	813-2042 Price gr. A175 (m ²)	
medium sand beige <input type="checkbox"/>	410-2043 Price gr. A238 (m ²)	610-2043 Price gr. A211 (m ²)	810-2043 Price gr. A175 (m ²)				



² Upon request, defined color nuances and mosaic pictures can also be supplied.

Floor Tiles

Cove Skirting³ Shower Tub System²

20 x 20 cm



30 x 60 cm¹



10 x 10 cm



10 x 10 cm



10 x 10 cm



protected

		20 x 20 / 8 x 8	30 x 60 / 12 x 24	10 x 10 / 4 x 4	10 x 10 / 4 x 4	10 x 10 / 4 x 4	
		197 x 197 x 6.5 mm	297 x 597 x 6 mm	100 x 97 x 6.5 mm	97 x 97 x 6.5 mm	97 x 97 x 6.5 mm	Nom. dim. - cm/in
		smooth, matt	smooth, matt	smooth, matt	smooth, matt	smooth, matt	Work size
		25.000/m ²	5.556/m ²	10.000/m	10.000/m		Surface
		13.875/m ²	13.273/m ²	1.500/m	1.700/m	0.170/pieces	m ² /m - pieces
		25	10	40	16	4	m ² /m/pce. - kg
		1.000 m ²	1.800/m ²	4.000 m	1.600 m		Bundle - pieces
		13.875	23.890	6.000	2.720	0.680	Bundle - m ² /m
		72.000	71.994				Bundle - m ²
		999.000	955.600				Bundle - kg
		Bla	Bla	Bla	Bla	Bla	Product standard
		R10/B	R10/B	R10/B	R10/B	R10/B	Slip resistance
		1	1				Stress group
		815-2113	806-2113	864-2113	885-2113	886-2113	neutral 3
		Price gr. A115 (m ²)	Price gr. A121 (m ²)	Price gr. A419 (pce.)	Price gr. A445 (pce.)	Price gr. A475 (pce.)	(asphalt black) <input type="checkbox"/>
		815-2111	806-2111	864-2111	885-2111	886-2111	neutral 1
		Price gr. A115 (m ²)	Price gr. A121 (m ²)	Price gr. A419 (pce.)	Price gr. A445 (pce.)	Price gr. A475 (pce.)	(deep black) <input type="checkbox"/>
		815-2008		864-2008	885-2008	886-2008	dark blue <input type="checkbox"/>
		Price gr. A148 (m ²)		Price gr. A419 (pce.)	Price gr. A445 (pce.)	Price gr. A475 (pce.)	
				864-2016			dark green <input type="checkbox"/>
				Price gr. A419 (pce.)			
		815-2023		864-2023	885-2023	886-2023	medium ochre <input type="checkbox"/>
		Price gr. A148 (m ²)		Price gr. A419 (pce.)	Price gr. A445 (pce.)	Price gr. A475 (pce.)	
				864-2033			active stone grey <input type="checkbox"/>
				Price gr. A419 (pce.)			
		815-2038	806-2038	864-2038	885-2038	886-2038	sand-white <input type="checkbox"/>
		Price gr. A115 (m ²)	Price gr. A121 (m ²)	Price gr. A419 (pce.)	Price gr. A445 (pce.)	Price gr. A475 (pce.)	
		815-2039		864-2039	885-2039	886-2039	medium sand-grey <input type="checkbox"/>
		Price gr. A115 (m ²)		Price gr. A419 (pce.)	Price gr. A445 (pce.)	Price gr. A475 (pce.)	
		815-2040		864-2040	885-2040	886-2040	dark sand-grey <input type="checkbox"/>
		Price gr. A115 (m ²)		Price gr. A419 (pce.)	Price gr. A445 (pce.)	Price gr. A475 (pce.)	
		815-2041		864-2041	885-2041	886-2041	medium brown <input type="checkbox"/>
		Price gr. A148 (m ²)		Price gr. A419 (pce.)	Price gr. A445 (pce.)	Price gr. A475 (pce.)	
		815-2042	806-2042	864-2042	885-2042	886-2042	medium grey <input type="checkbox"/>
		Price gr. A148 (m ²)	Price gr. A121 (m ²)	Price gr. A419 (pce.)	Price gr. A445 (pce.)	Price gr. A475 (pce.)	
		815-2043		864-2043	885-2043	886-2043	medium sand beige <input type="checkbox"/>
		Price gr. A148 (m ²)		Price gr. A419 (pce.)	Price gr. A445 (pce.)	Price gr. A475 (pce.)	



² For details, refer to page 292

³ For details, refer to page 294 and the following



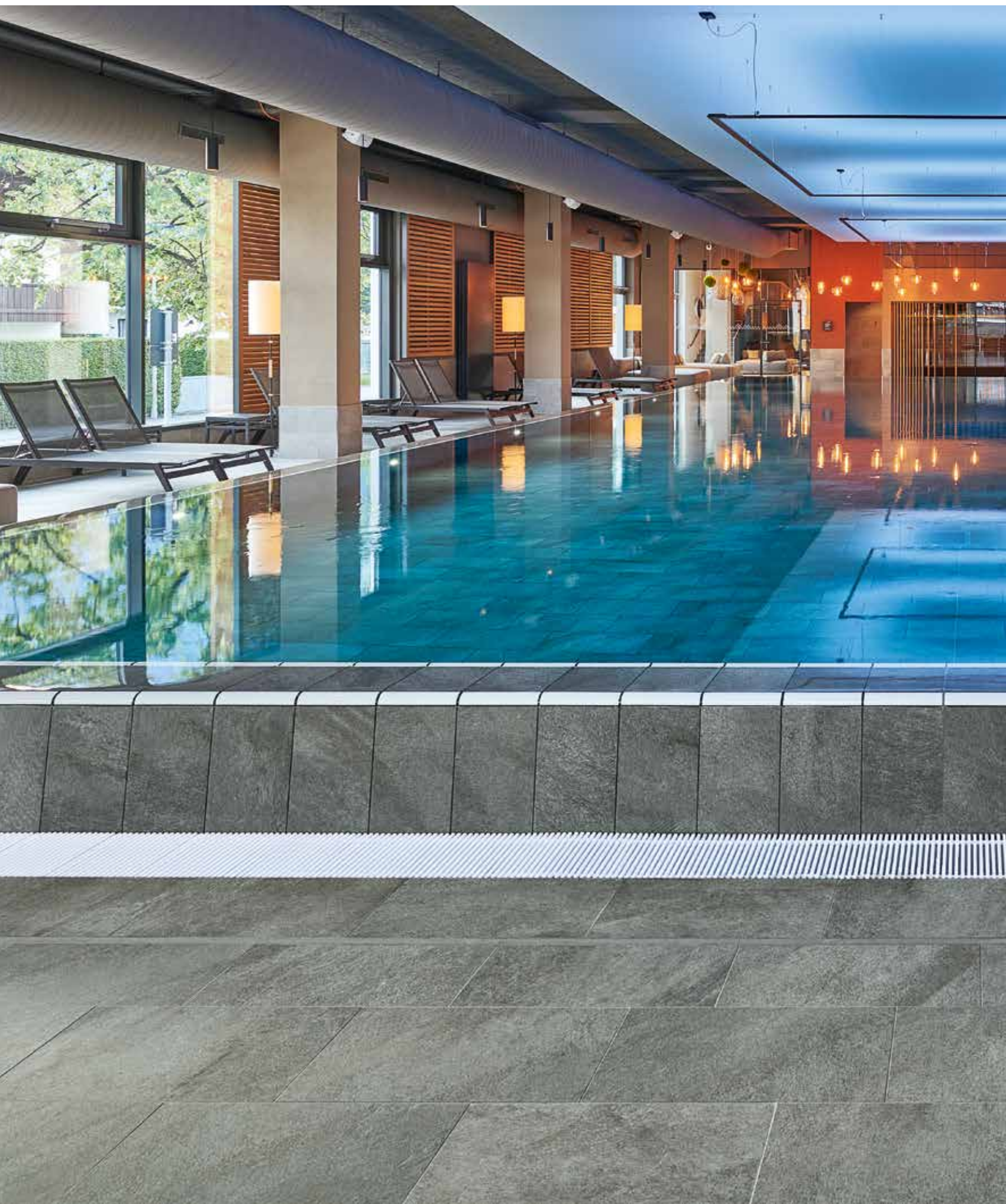



Natural and lively

Besides its natural look, Quarzit is impressive because of unusual characteristics, which are based on an innovative glazing process. The glaze, which is enriched with a granulate, is applied and durably bonded to the tile body during firing. The result is a surface vividly nuanced by discreet gloss and mica spots in an authentic stone look. In addition to the aesthetic advantages, there are also practical ones: pleasant haptics is combined with high slip resistance and enormous wear resistance.

Hotel aja, Garmisch-Partenkirchen, Germany / Architect: SMAP SEEGER
MÜLLER Berlin (Germany) and Büro Korb / Series: Pool edge system
St. Moritz, Quarzit / Photo: Fotodesign Peters, Amerang



basalt-grey



quarz-grey



sand-beige



sepia-brown



white-grey

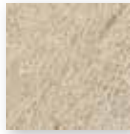

Floor tile 12.5 x 12.5 cm, 5 x 5 in structured, R11/B



Floor tile 12.5 x 25 cm, 5 x 10 in structured, R11/B

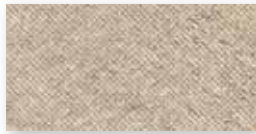

Grid profile tile 12.5 x 25 cm, 5 x 10 in relief, R11/C



Floor tile 15 x 15 cm, 6 x 6 in structured, R11/C



Floor tile 25 x 25 cm, 10 x 10 in structured, R10/A,
Floor tile 25 x 25 cm, 10 x 10 in structured, R11/B

Mosaic 5 x 5 cm, 2 x 2 in



Mosaic sheet 30 x 30 cm, 12 x 12 in structured, R11/B



Floor tile 25 x 50 cm, 10 x 20 in, structured, R10/A
Floor tile 25 x 50 cm, 10 x 20 in, structured, R11/B



Floor tile 30 x 60 cm, 12 x 24 in, structured, R10/A
Floor tile 30 x 60 cm, 12 x 24 in, structured, R11/B

Mosaic: glass fibre net on reverse side,
sheet: 297 x 297 mm



Floor tile 60 x 60 cm, 24 x 24 in, structured, R10/A
Patio tile 60 x 60 cm, 24 x 24 in, structured, R11/B



Stair tile with bevel 31 x 145 cm, 12 13/64 x 57 in, structured, R10/A



Riser 28 x 145 cm, 11 x 57 in, structured



R11/B R11/C



basalt-grey



quarz-grey



sand-beige



sepia-brown



white-grey



Letter tile 25 x 50 cm, 10 x 20 in, structured, R11/B



Skirting, cut 6 x 50 cm, 2 3/8 x 20 in, structured



Skirting, cut 6 x 60 cm, 2 3/8 x 24 in, structured



Cove skirting decorated 10 x 60 cm, 4 x 24 in, structured



Grooved tile 50 x 25 cm, 20 x 10 in grooved, R11/C



Grooved tile 25 x 25 cm, 10 x 10 in grooved, R11/C



Grooved tile 12,5 x 25 cm, 5 x 10 in grooved, R11/C



Grid profile tile 25 x 50 cm, 10 x 20 in, relief, R11/C

Gutter tile (trough depth 5 mm)



Gutter tile 50 x 25 cm, 20 x 10 in, structured, R11/B

without illustration: Gutter tile with outlet, mitred pair, terminal piece

Ceramic channel cover 50 x 25 cm, 20 x 10 in, structured



Ceramic channel cover corner solution 30 x 30 cm, 12 x 12 in, structured



For details to Gutter tiles refer to page 114 and the following.
For details to Ceramic channel cover refer to page 82 and the following.

Floor Tiles 3 mm joint

5 x 5 cm^{1/4}



15 x 15 cm



25 x 25 cm¹



25 x 25 cm¹



25 x 50 cm¹

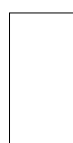

25 x 50 cm¹



25 x 50 cm^{1/2}



Sheet: 297 x 297 mm

7161H	342030H	332050HK	332050HK	342550HK	342550HK	342580HK	Grid profile tile	Model number
5 x 5 / 2 x 2	15 x 15 / 6 x 6	25 x 25 / 10 x 10	25 x 25 / 10 x 10	25 x 50 / 10 x 20	25 x 50 / 10 x 20	25 x 50 / 10 x 20		Nom. dim. - cm/in
47 x 47 x 8 mm	147 x 147 x 8 mm	247 x 247 x 8 mm	247 x 247 x 8 mm	247 x 497 x 8 mm	247 x 497 x 8 mm	247 x 497 x 8 mm		Work size
structured, matt	structured, matt	structured, matt	structured, matt	structured, matt	structured, matt	relief, matt		Surface
11.111	44.444	16.000	16.000	8.000	8.000	8.000		m ² - pieces
16.389	17.555	16.960	16.960	17.040	17.040	17.040		m ² - kg
14	35	14	14	9	9	9		Bundle - pieces
1.260	0.788	0.875	0.875	1.125	1.125	1.125		Bundle - m ²
20.650	13.825	14.840	14.840	19.170	19.170	19.170		Bundle - kg
37.800	63.001	70.875	70.875	40.500	40.500	40.500		Pallet - m ²
619.500	1,106.000	1,202.040	1,202.040	690.120	690.120	690.120		Pallet - kg
Ala	Bla	Ala	Ala	Ala	Ala	Ala		Product standard
R11/B	R11/C	R10/A	R11/B	R10/A	R11/B	R11/C		Slip resistance
2	2	2	2	2	2	2		Stress group
8460-7161H	8460-342030H	8450-332050HK	8460-332050HK	8450-342550HK	8460-342550HK	8460-342580HK		basalt-grey <input type="checkbox"/> V4
Price gr. A289 (m ²)	Price gr. A157 (m ²)	Price gr. A148 (m ²)	Price gr. A157 (m ²)	Price gr. A157 (m ²)	Price gr. A166 (m ²)	Price gr. A181 (m ²)		
8461-7161H	8461-342030H	8451-332050HK	8461-332050HK	8451-342550HK	8461-342550HK	8461-342580HK		quartz-grey <input type="checkbox"/> V4
Price gr. A289 (m ²)	Price gr. A157 (m ²)	Price gr. A148 (m ²)	Price gr. A157 (m ²)	Price gr. A157 (m ²)	Price gr. A166 (m ²)	Price gr. A181 (m ²)		
8462-7161H	8462-342030H	8452-332050HK	8462-332050HK	8452-342550HK	8462-342550HK	8462-342580HK		sand-beige <input type="checkbox"/> V4
Price gr. A289 (m ²)	Price gr. A157 (m ²)	Price gr. A148 (m ²)	Price gr. A157 (m ²)	Price gr. A157 (m ²)	Price gr. A166 (m ²)	Price gr. A181 (m ²)		
8463-7161H	8463-342030H	8453-332050HK	8463-332050HK	8453-342550HK	8463-342550HK	8463-342580HK		sepia-brown <input type="checkbox"/> V4
Price gr. A289 (m ²)	Price gr. A157 (m ²)	Price gr. A148 (m ²)	Price gr. A157 (m ²)	Price gr. A157 (m ²)	Price gr. A166 (m ²)	Price gr. A181 (m ²)		
8464-7161H	8464-342030H	8454-332050HK	8464-332050HK	8454-342550HK	8464-342550HK	8464-342580HK		white-grey <input type="checkbox"/> V4
Price gr. A289 (m ²)	Price gr. A157 (m ²)	Price gr. A148 (m ²)	Price gr. A157 (m ²)	Price gr. A157 (m ²)	Price gr. A166 (m ²)	Price gr. A181 (m ²)		



Floor Tiles 3 mm joint¹

30 x 60 cm



30 x 60 cm



60 x 60 cm

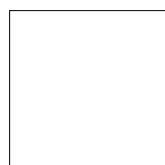

12.5 x 12.5 cm³



12.5 x 25 cm



12.5 x 25 cm²



B200HK	B200HK	B600HK	32020H	38110H	34090H	Grid profile tile	Model number
30 x 60 / 12 x 24	30 x 60 / 12 x 24	60 x 60 / 24 x 24	12.5 x 12.5 / 5 x 5	12.5 x 25 / 5 x 10	12.5 x 25 / 5 x 10		Nom. dim. - cm/in
297 x 597 x 8 mm	297 x 597 x 8 mm	597 x 597 x 8 mm	119 x 119 x 8 mm	119 x 244 x 8 mm	119 x 244 x 8 mm		Work size
structured, matt	structured, matt	structured, matt	structured, matt	structured, matt	relief, matt		Surface
5.556	5.556	2.778	64.000	32.000	32.000		m ² - pieces
17.413	17.413	18.001	15.360	15.680	15.360		m ² - kg
6	6	4	66	33	33		Bundle - pieces
1.080	1.080	1.440	1.031	1.031	1.031		Bundle - m ²
18.804	18.804	25.920	15.840	16.170	15.840		Bundle - kg
43.197	43.197	43.197	86.625	86.625	86.625		Pallet - m ²
752.160	752.160	777.600	1,330.560	1,358.280	1,330.560		Pallet - kg
Ala	Ala	Ala	Ala	Ala	Ala		Product standard
R10/A	R11/B	R10/A	R11/B	R11/B	R11/C		Slip resistance
2	2	2	2	2	2		Stress group
8450-B200HK	8460-B200HK	8450-B600HK	8460-32020H	8460-38110H	8460-34090H		basalt-grey <input type="checkbox"/> V4
Price gr. A124 (m ²)	Price gr. A142 (m ²)	Price gr. A136 (m ²)	Price gr. A157 (m ²)	Price gr. A127 (m ²)	Price gr. A148 (m ²)		
8451-B200HK	8461-B200HK	8451-B600HK	8461-32020H	8461-38110H	8461-34090H		quartz-grey <input type="checkbox"/> V4
Price gr. A124 (m ²)	Price gr. A142 (m ²)	Price gr. A136 (m ²)	Price gr. A157 (m ²)	Price gr. A127 (m ²)	Price gr. A148 (m ²)		
8452-B200HK	8462-B200HK	8452-B600HK	8462-32020H	8462-38110H	8462-34090H		sand-beige <input type="checkbox"/> V4
Price gr. A124 (m ²)	Price gr. A142 (m ²)	Price gr. A136 (m ²)	Price gr. A157 (m ²)	Price gr. A127 (m ²)	Price gr. A148 (m ²)		
8453-B200HK	8463-B200HK	8453-B600HK	8463-32020H	8463-38110H	8463-34090H		sepia-brown <input type="checkbox"/> V4
Price gr. A124 (m ²)	Price gr. A142 (m ²)	Price gr. A136 (m ²)	Price gr. A157 (m ²)	Price gr. A127 (m ²)	Price gr. A148 (m ²)		
8454-B200HK	8464-B200HK	8454-B600HK	8464-32020H	8464-38110H	8464-34090H		white-grey <input type="checkbox"/> V4
Price gr. A124 (m ²)	Price gr. A142 (m ²)	Price gr. A136 (m ²)	Price gr. A157 (m ²)	Price gr. A127 (m ²)	Price gr. A148 (m ²)		

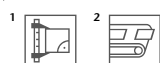

³ Supplied as double-tiles; to be broken by customer
⁴ Glass fibre net on reverse side

Stair Tile with Bevel^{2/3/5}

31 x 145 cm

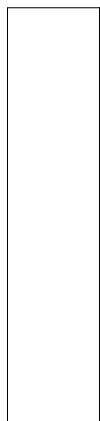

Riser^{2/3/5}

28 x 145 cm



Skirting, cut¹

6 x 50 cm



6 x 60 cm



Cove Skirting, decorated^{1/2/6}

10 x 60 cm



Letter Tile^{1/2/4}

25 x 50 cm

WT. 1.35m



Type height 7 cm

Model number	B773HK	B774HK	342557HK	B611HK	B612HK	342555HK
Nom. dim. - cm/in	31 x 145 / 12 3/8 x 58	28 x 145 / 11 3/16 x 58	6 x 50 / 2 3/8 x 20	6 x 60 / 2 3/8 x 24	10 x 60 / 4 x 24	25 x 50 / 10 x 20
Work size	307 x 1447 x 10.5 mm	280 x 1447 x 10.5 mm	60 x 497 x 8 mm	60 x 597 x 8 mm	100 x 597/35 x 9 mm	247 x 497 x 8 mm
Surface	structured, matt	structured, matt	structured, matt	structured, matt	structured, matt	structured, matt
m - pieces	0.690	0.690	2.000	1.667	1.667	2
St./m - kg	7.480/m	6.716/m	1.098/m	1.100/m	2.000/m	2.130/pieces
Bundle - pieces	2	2	30	34	20	
Bundle - m	2.899	2.899	15.000	20.396	11.998	
Bundle - kg	21.682	19.466	16.470	22.440	24.000	
Pallet - m						
Pallet - kg						
Product standard	Ala	Ala	Ala	Ala	Alb	Ala
Slip resistance	R10/A	R10/A				R11/B
Stress group	2	2				
basalt-grey 	8450-B773HK Price gr. A560 (pce.)	8450-B774HK Price gr. A528 (pce.)	8450-342557HK Price gr. A434 (pce.)	8450-B611HK Price gr. A434 (pce.)	8450-B612HK Price gr. A445 (pce.)	900725-342555HK Price gr. A668 (pce.)
quartz-grey 	8451-B773HK Price gr. A560 (pce.)	8451-B774HK Price gr. A528 (pce.)	8451-342557HK Price gr. A434 (pce.)	8451-B611HK Price gr. A434 (pce.)	8451-B612HK Price gr. A445 (pce.)	900726-342555HK Price gr. A668 (pce.)
sand-beige 	8452-B773HK Price gr. A560 (pce.)	8452-B774HK Price gr. A528 (pce.)	8452-342557HK Price gr. A434 (pce.)	8452-B611HK Price gr. A434 (pce.)	8452-B612HK Price gr. A445 (pce.)	900713-342555HK Price gr. A668 (pce.)
sepia-brown 	8453-B773HK Price gr. A560 (pce.)	8453-B774HK Price gr. A528 (pce.)	8453-342557HK Price gr. A434 (pce.)	8453-B611HK Price gr. A434 (pce.)	8453-B612HK Price gr. A445 (pce.)	900714-342555HK Price gr. A668 (pce.)
white-grey 	8454-B773HK Price gr. A560 (pce.)	8454-B774HK Price gr. A528 (pce.)	8454-342557HK Price gr. A434 (pce.)	8454-B611HK Price gr. A434 (pce.)	8454-B612HK Price gr. A445 (pce.)	900719-342555HK Price gr. A668 (pce.)



³ Only rectified on the two short sides. The long side can not be rectified.

⁴ Only figures/letters can be realized.

Color combination:

Base color: basalt-grey, quartz-grey, sand-beige, sepia-brown,
color of letters: active white / neutral 10.

⁵ For details, refer to page 296. For further solutions regarding stair designs, refer to the series Area Pro in the 2024 programme of delivery.

⁶ For detailed drawings of cove skirting, see page 294 and the following.

Patio Tile^{1/4}

60 x 60 cm

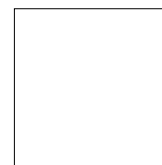

						61061HK	Model number
						60 x 60 / 24 x 24	Nom. dim. - cm/in
						597 x 597 x 20 mm	Work size mm
						structured, matt	Surface
						2.778	m ² - pieces
						43.059	m ² - kg
						1	Bundle - pieces
						0.360	Bundle - m ²
						15.500	Bundle - kg
						17.280	Pallet - m ²
						744.000	Pallet - kg
						Alla	Product standard
						R11/B	Slip resistance
						3	Stress group
						8460-61061HK	4
						Price gr. A220 (m ²)	basalt-grey <input type="checkbox"/> V4
						8461-61061HK	4
						Price gr. A220 (m ²)	quartz-grey <input type="checkbox"/> V4
						8462-61061HK	4
						Price gr. A220 (m ²)	sand-beige <input type="checkbox"/> V4



Gutter Tiles^{2/3/6}
(trough depth 5 mm)

50 x 25 cm



Gutter tile

50 x 25 cm⁵

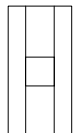

Gutter tile with outlet
110 / 110 mm

50 x 25 cm

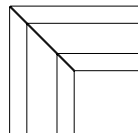

Gutter tile, mitred pair

50 x 25 cm⁵

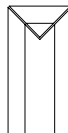

Gutter tile, terminal piece

Grooved Tiles 12.5 mm thick,
for continuing the Pool Edge System "Finland II"^{2/6}

50 x 25 cm

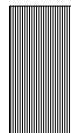

25 x 25 cm



12.5 x 25 cm



53320	53321	53322	53323	53151	53150	53159	Model number
50 x 25 / 20 x 10	50 x 25 / 20 x 10			50 x 25 / 20 x 10	25 x 25 / 10 x 10	12.5 x 25 / 5 x 10	Nom. dim. - cm/in
494 x 244 x 14	494 x 244 x 14	(2x) 487 x 244 x 14	494 x 244 x 14	494 x 244 x 12.5	244 x 244 x 12.5	119 x 244 x 12.5	Work size mm
structured, matt	structured, matt	structured, matt	structured, matt	grooved, matt	grooved, matt	grooved, matt	Surface
2.000				2.000	4.000	8.000	m - pieces
2.500/pieces	2.300/pieces	3.800/pair	2.500/pieces	3.550/pieces	1.775/pieces	0.888/pieces	Pce./pair - kg
5 pieces	5 pieces	2 pair	5 pieces	6 pieces	9 pieces	21 pieces	Bundle - pce./pair
2.500				3.000	2.250	2.625	Bundle - m
12.500	11.500	7.600	12.500	21.300	15.975	18.648	Bundle - kg
							Pallet - m
							Pallet - kg
							Product standard
Ala	Ala	Ala	Ala	Ala	Ala	Ala	Slip resistance
R11/B	R11/B	R11/B	R11/B	R11/C	R11/C	R11/C	
8460-53320H	8460-53321H	8460-53322H	8460-53323H	8460-53151	8460-53150	8460-53159	basalt-grey <input type="checkbox"/> V4
Price gr. A519 (pce.)	Price gr. A593 (pce.)	Price gr. A645 (pair)	Price gr. A593 (pce.)	Price gr. A560 (pce.)	Price gr. A480 (pce.)	Price gr. A430 (pce.)	
8461-53320H	8461-53321H	8461-53322H	8461-53323H	8461-53151	8461-53150	8461-53159	quartz-grey <input type="checkbox"/> V4
Price gr. A519 (pce.)	Price gr. A593 (pce.)	Price gr. A645 (pair)	Price gr. A593 (pce.)	Price gr. A560 (pce.)	Price gr. A480 (pce.)	Price gr. A430 (pce.)	
8462-53320H	8462-53321H	8462-53322H	8462-53323H	8462-53151	8462-53150	8462-53159	sand-beige <input type="checkbox"/> V4
Price gr. A519 (pce.)	Price gr. A593 (pce.)	Price gr. A645 (pair)	Price gr. A593 (pce.)	Price gr. A560 (pce.)	Price gr. A480 (pce.)	Price gr. A430 (pce.)	
8463-53320H	8463-53321H	8463-53322H	8463-53323H	8463-53151	8463-53150	8463-53159	sepia-brown <input type="checkbox"/> V4
Price gr. A519 (pce.)	Price gr. A593 (pce.)	Price gr. A645 (pair)	Price gr. A593 (pce.)	Price gr. A560 (pce.)	Price gr. A480 (pce.)	Price gr. A430 (pce.)	
8464-53320H	8464-53321H	8464-53322H	8464-53323H	8464-53151	8464-53150	8464-53159	white-grey <input type="checkbox"/> V4
Price gr. A519 (pce.)	Price gr. A593 (pce.)	Price gr. A645 (pair)	Price gr. A593 (pce.)	Price gr. A560 (pce.)	Price gr. A480 (pce.)	Price gr. A430 (pce.)	

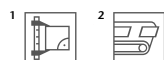

³ On request, also available in a length of 497 mm.
⁴ High weight only to carry with two persons.
⁵ Minimum order quantity 10 pieces. The price must be calculated individually for orders of less than 10 units.
⁶ Short edge rectified

For details to gutter tiles and grooved tiles refer to chapter swimming pool special pieces.



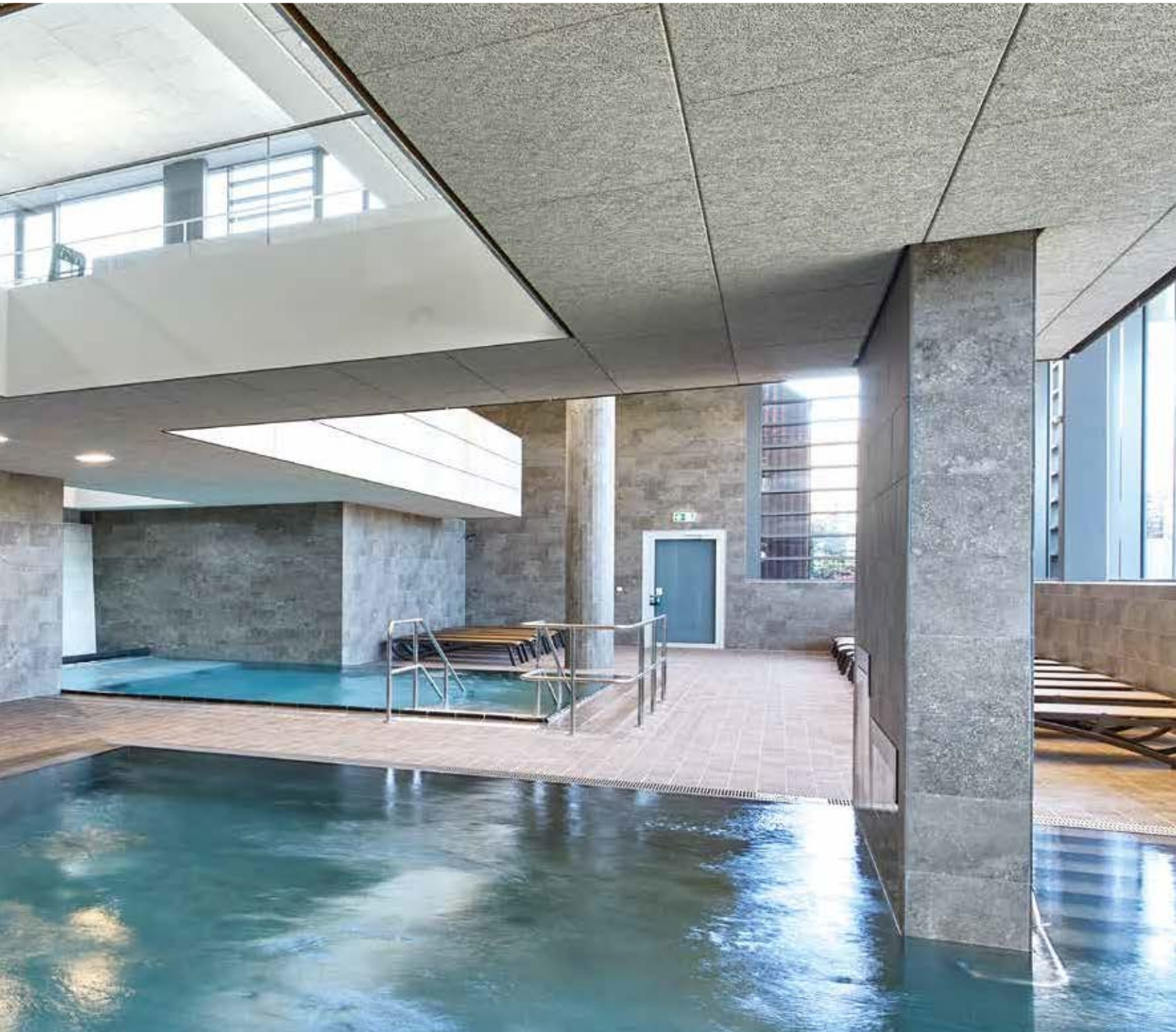

Elegant and timeless

Structures and colors of various rocks from the Italian coastal region of "Cinque Terre" merge in the Savona floor tile series to create a lively composition of coarsegrained texture and soft layers. A finely dosed granulate application gives the surface a pleasantly stony look and haptics. Mica-like glossy spots underline the natural effect.

SaLü Salztherme, Lüneburg, Germany / Architect: bs2 architekten gmbh
Series: Savona / Photo: Jochen Stüber



lime



beige



brown



grey



anthracite



Floor tile 15 x 15 cm, 6 x 6 in structured, R11/C



Floor tile 30 x 60 cm, 12 x 24 in, structured, R10/A
Floor tile 30 x 60 cm, 12 x 24 in, structured, R11/B



Floor tile 60 x 60 cm, 24 x 24 in, structured, R10/A
Floor tile 60 x 60 cm, 24 x 24 in, structured, R11/B



Skirting, cut 6 x 60 cm, 2 3/8 x 24 in, structured

Mosaic 5 x 5 cm, 2 x 2 in



Mosaic sheet 30 x 30 cm, 12 x 12 in structured, R11/B

Mosaic: glass fibre net on reverse side,
sheet: 297 x 297 mm



Floor tile 60 x 120 cm, 24 x 48 in, structured, R10/A



*Washbasin SURF® large 55 x 120 cm, 22 x 48 in (available on request).
Further information about Surf® in the 2024 programme of delivery.*

Mosaic^{1/2}

Floor Tiles

5 x 5 cm



15 x 15 cm



30 x 60 cm¹



30 x 60 cm¹

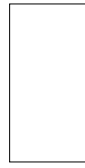

60 x 60 cm¹



60 x 60 cm¹

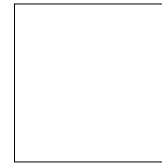

60 x 120 cm¹

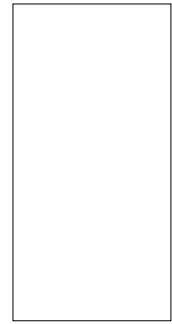

Sheet: 297 x 297 mm

Model number	7161H	342030H	B200HK	B200HK	B600HK	B600HK	B670HK
Nom. dim. - cm/in	5 x 5 / 2 x 2	15 x 15 / 6 x 6	30 x 60 / 12 x 24	30 x 60 / 12 x 24	60 x 60 / 24 x 24	60 x 60 / 24 x 24	60 x 120 / 24 x 48
Work size	47 x 47 x 8 mm	147 x 147 x 8 mm	297 x 597 x 8 mm	297 x 597 x 8 mm	597 x 597 x 8 mm	597 x 597 x 8 mm	597 x 1197 x 8 mm
Surface	structured, matt	structured, matt	structured, matt	structured, matt	structured, matt	structured, matt	structured, matt
m ² - pieces	11.111	44.444	5.556	5.556	2.778	2.778	1.389
m ² - kg	16.389	17.555	17.413	17.413	18.001	18.001	17.501
Bundle - pieces	14	35	6	6	4	4	2
Bundle - m ²	1.260	0.788	1.080	1.080	1.440	1.440	1.440
Bundle - kg	20.650	13.825	18.804	18.804	25.920	25.920	25.200
Pallet - m ²	37.800	63.001	43.197	43.197	43.197	43.197	36.023
Pallet - kg	619.500	1,106.000	752.160	752.160	777.600	777.600	630.000
Product standard	Ala	Bla	Ala	Ala	Ala	Ala	Ala
Slip resistance	R11/B	R11/C	R10/A	R11/B	R10/A	R11/B	R10/A
Stress group	2	2	2	2	2	2	2
lime	8810-7161H Price gr. A289 (m ²)	8810-342030H Price gr. A157 (m ²)	8800-B200HK Price gr. A124 (m ²)	8810-B200HK Price gr. A142 (m ²)	8800-B600HK Price gr. A136 (m ²)	8810-B600HK Price gr. A151 (m ²)	8800-B670HK Price gr. A166 (m ²)
beige	8811-7161H Price gr. A289 (m ²)	8811-342030H Price gr. A157 (m ²)	8801-B200HK Price gr. A124 (m ²)	8811-B200HK Price gr. A142 (m ²)	8801-B600HK Price gr. A136 (m ²)	8811-B600HK Price gr. A151 (m ²)	8801-B670HK Price gr. A166 (m ²)
brown	8812-7161H Price gr. A289 (m ²)	8812-342030H Price gr. A157 (m ²)	8802-B200HK Price gr. A124 (m ²)	8812-B200HK Price gr. A142 (m ²)	8802-B600HK Price gr. A136 (m ²)	8812-B600HK Price gr. A151 (m ²)	8802-B670HK Price gr. A166 (m ²)
grey	8813-7161H Price gr. A289 (m ²)	8813-342030H Price gr. A157 (m ²)	8803-B200HK Price gr. A124 (m ²)	8813-B200HK Price gr. A142 (m ²)	8803-B600HK Price gr. A136 (m ²)	8813-B600HK Price gr. A151 (m ²)	8803-B670HK Price gr. A166 (m ²)
anthracite	8814-7161H Price gr. A289 (m ²)	8814-342030H Price gr. A157 (m ²)	8804-B200HK Price gr. A124 (m ²)	8814-B200HK Price gr. A142 (m ²)	8804-B600HK Price gr. A136 (m ²)	8814-B600HK Price gr. A151 (m ²)	8804-B670HK Price gr. A166 (m ²)



Skirting, cut¹

6 x 60 cm



Model number	B611HK						
Nom. dim. - cm/in	6 x 60 / 2 3/8 x 24						
Work size	60 x 597 x 8 mm						
Surface	structured, matt						
m - pieces	1.667						
m - kg	1.100						
Bundle - pieces	34						
Bundle - m	20.396						
Bundle - kg	22.440						
Pallet - m							
Pallet - kg							
Product standard	Ala						
lime	8800-B611HK Price gr. A434 (pce.)						
beige	8801-B611HK Price gr. A434 (pce.)						
brown	8802-B611HK Price gr. A434 (pce.)						
grey	8803-B611HK Price gr. A434 (pce.)						
anthracite	8804-B611HK Price gr. A434 (pce.)						



² Glass fibre net on reverse side

Studio photo / Architect: VSBL, Belgrade, Serbia / Photo: Jochen Stüber





Designing with mosaics



Visual variety

Ceramic mosaics offer first-class possibilities for realizing architectural ideas individually and functionally. The range of colors and formats and their combinations or also a tone-in-tone design make unusual appearances possible.

This can visually characterize the entire pool and spa project or be used to emphasize specific areas such as stairs and pool edges or to create pictures with mosaics.

The products meet high standards in terms of slip resistance and hygiene - also in underwater and permanently wet areas - and thanks to the many years of collaboration with architects and planners, they offer well thought-out solutions in and around the pool.

Schwaketenbad, Konstanz, Germany
Architect: Behnisch / Series: Loop / Photo: David Matthiessen

Decorative details: mosaics

With mosaic tiles, decorative design concepts can also be realized with very small formats. AGROB BUCHTAL offers an extensive range with bold colors and unusual formats for swimming pools and wellness areas.

All mosaics meet the high standards with regard to slip resistance and hygiene – also in underwater, permanently wet areas and steam saunas. This is where the advantages of the thermo-plastic glueing come in useful. Thanks to this new processing method – microbiologically and structural-physically certified – the mosaics satisfy all requirements in and around the pool. In addition, laying is considerably facilitated – compared to the usual film glued on the front side – even in complex areas such as columns or curves thanks to the grid glued on the reverse side.



Lintharena, Näfels, Switzerland
 Architect: K & L Architekten AG, St. Gallen, Switzerland
 Series: Loop
 Photo: Kim Britt Photography



Sports pool Friedrichshafen, Germany
 Architect: Behnisch Architekten, Stuttgart, Germany
 Series: Loop
 Photo: David Matthiessen, Stuttgart



Indoor swimming pool Oberuzwil, Switzerland
 Architect: Hunziker Betatech AG, Winterthur, Switzerland
 Series: Fresh, Quarzit, Special production
 Photo: Adriano Faragulo



Pool EW 23, Surabaya, Indonesia
 Architect: Ir. Sonny Njonoriswondo, Surabaya, Indonesia
 Series: Pool edge system Bamberg, Chroma non-slip. Fresh
 Photo: George Arif (Spin Production)

Hotel Schweizerhof, Lenzerheide, Switzerland
 Architect: Beck Schwimmbadbau AG, Winterthur, Switzerland
 Series: Plural non-slip, Quarzit
 Photo: Adriano Faragulo



School swimming pool Vogelsang of the primary school, Basel, Switzerland
 Architect: MET Architekten GmbH SIA, Basel, Switzerland
 Series: Pool edge system Wiesbaden,
 Swimming pool special programme, Chroma Pool, Loop
 Photo: Daniel Zehnder



Olympic indoor swimming pool, Munich, Germany
 Architect: planplus GmbH, Munich
 Series: Fresh
 Photo: Oliver Jung



Creative particle accelerator

Free your mind

The new mosaic design tool from AGROB BUCHTAL expands the horizons for architects and interior designers by giving them an infinite number of solutions when it comes to form, color and size. The digital service provides scope for new ideas and is convincing by an excellent user experience thanks to its intuitive, almost playful handling. A tool with which AGROB BUCHTAL is revolutionizing the ancient art of mosaics and bringing it to new life.

By entering the desired basic parameters such as the dimensions of the mosaic surface, selection of product series, tile format and joint color, individual color gradients or color mixtures can be generated automatically. Depending on the size, the desired design is generated and visualized on the screen in the shortest possible time.

103,968 mosaic tiles, each measuring 1 x 1 centimetre, are required for an area of 3 x 6 metres, for example – digitally

arranged and shaped in a flash. There is no limit to the size, which makes the Mosaic Designer from AGROB BUCHTAL a creative accelerator, especially for the design of swimming pools and wellness facilities, restaurants, hotels, schools and public areas such as e.g. underground stations.

There is a choice of the three mosaic series Loop, Fresh and Plural, which are ideal as pure color system series without surfaces such as wood, concrete, marble or the like and offer a wide spectrum of tonal values for the design. Each design can be saved as a project or sent immediately to AGROB BUCHTAL as an inquiry.

In addition to graphic gradients and color mixtures, the Mosaic Designer can also implement individual motifs. Images and photos can be directly uploaded using the upload function.

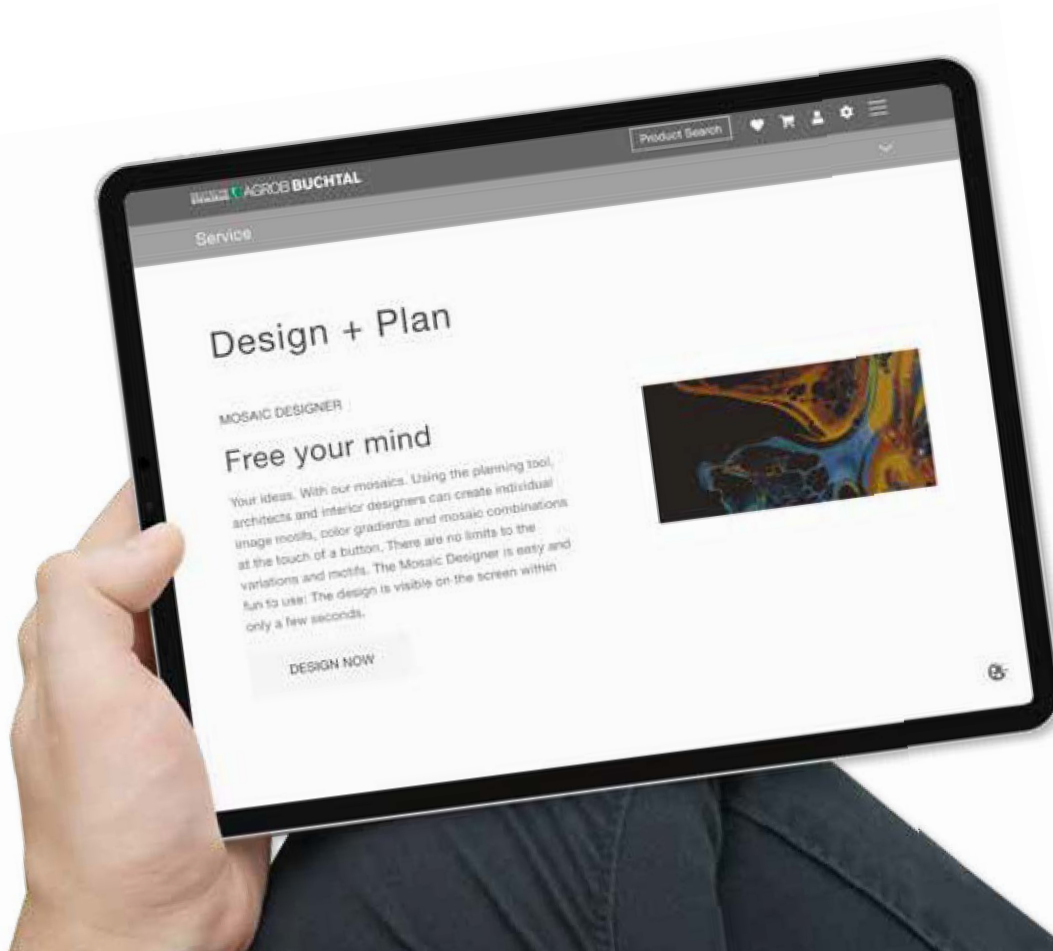

directly to the Mosaic Designer

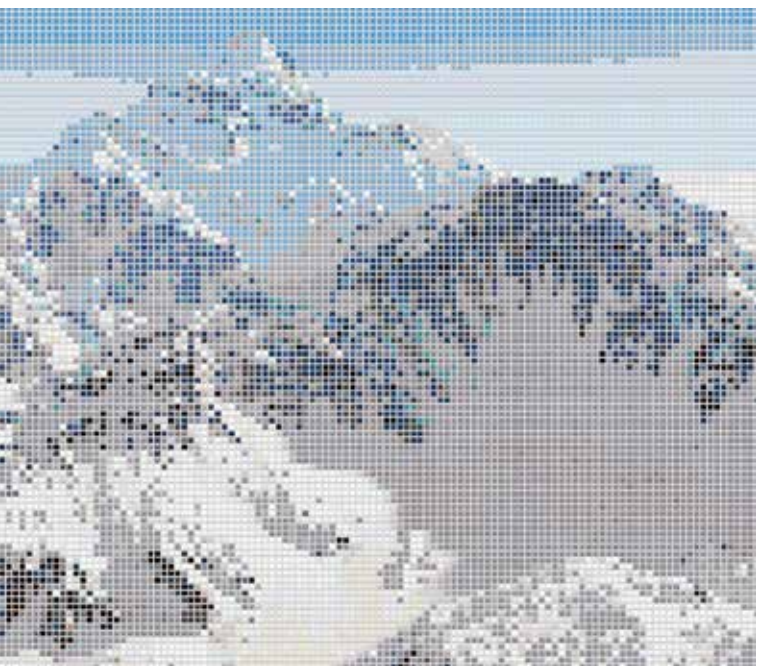
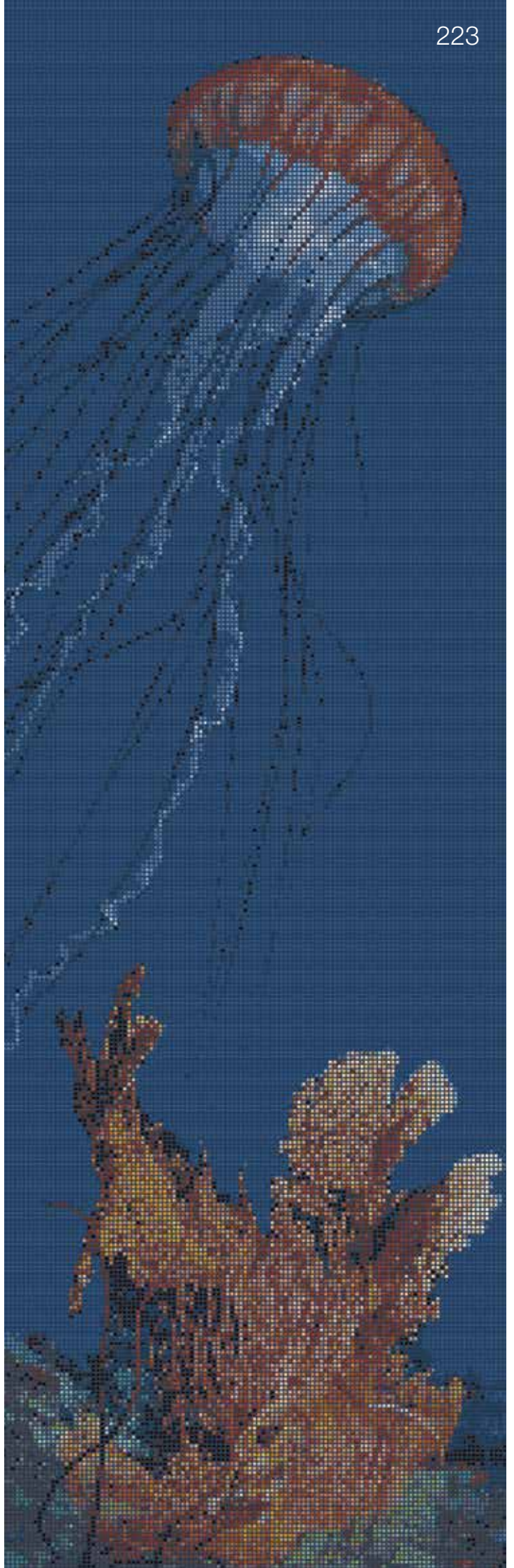
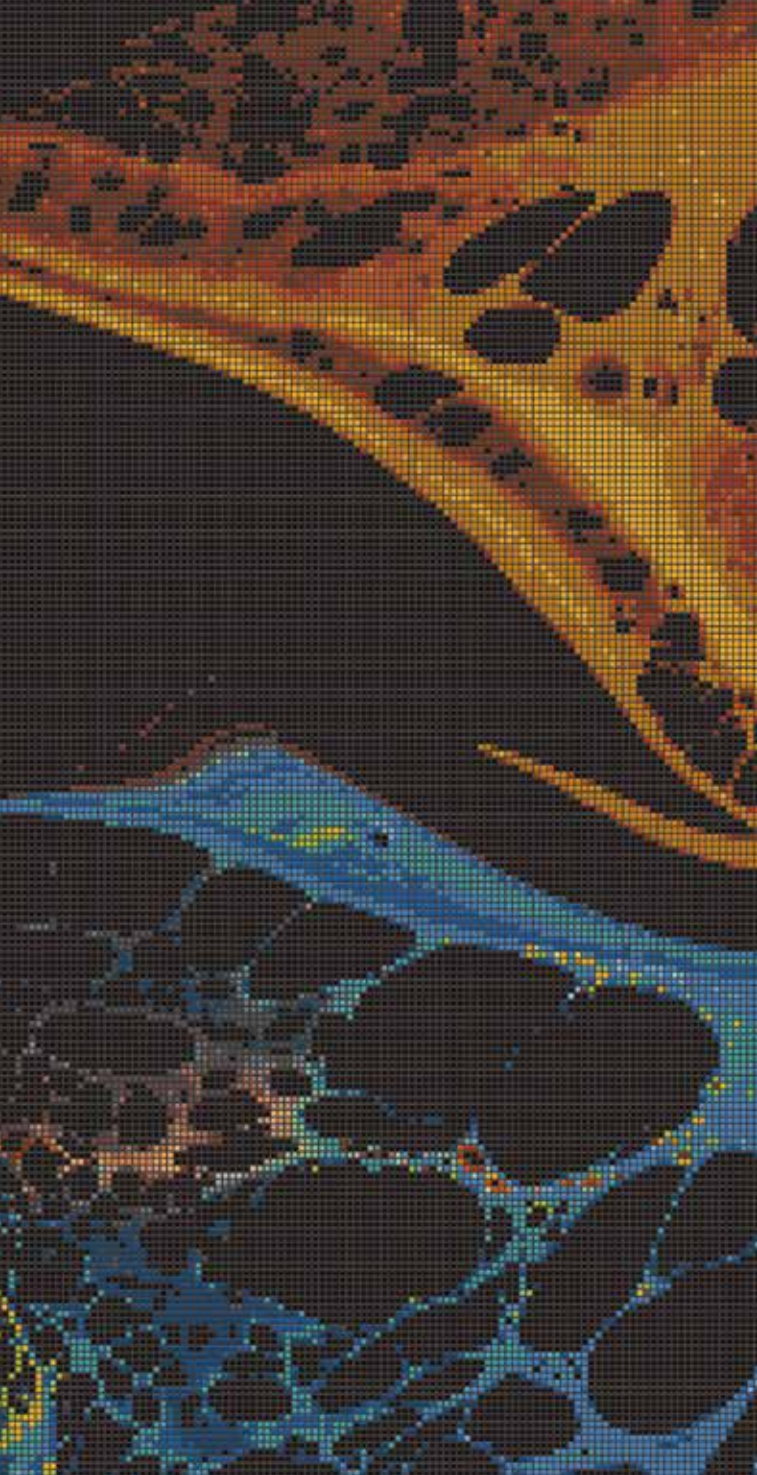





Fresh and modern

Fresh offers a harmonious range of modern, fresh colors in the popular mosaic formats of 2.5 x 2.5 cm and 5 x 5 cm, with which individual, but at the same time uncomplicated to realize designs are possible. A particularly practical advantage is that R10/B and R11/C slip-resistant mosaics in colors matching the tiles are available.

Schwaketenbad, Konstanz, Germany / Architect: Behnisch Architekten, Stuttgart, Germany / Series: Fresh, Plural unglazed
Photo: David Matthiessen, Stuttgart

Fresh: modern clarity for individual design

snow white	warm grey mix	desert sand-mix	taupe-mix	white grey mix	silver grey mix	light grey-mix	medium grey-mix	midnight black-mix	graphite black mix	deep blue mix	caribbean-blue-mix
------------	---------------	-----------------	-----------	----------------	-----------------	----------------	-----------------	--------------------	--------------------	---------------	--------------------

2.5 x 2.5 cm, 1 x 1 in

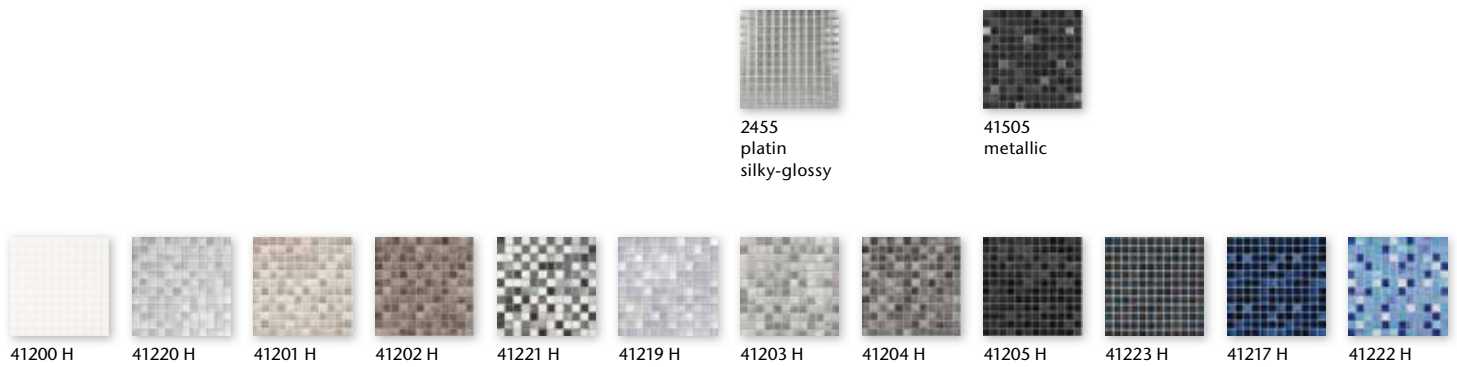

2.5 x 2.5 cm, 1 x 1 in, non-slip R10/B



5 x 5 cm, 2 x 2 in, non-slip R10/B & R11/C



denim blue-mix	light blue-mix	pacific blue-mix	midnight blue-mix	vivid violet-mix	sunset orange-mix	coral red-mix	brick red mix	mystic red-mix	forest green mix	lime green-mix	sunshine yellow-mix
----------------	----------------	------------------	-------------------	------------------	-------------------	---------------	---------------	----------------	------------------	----------------	---------------------

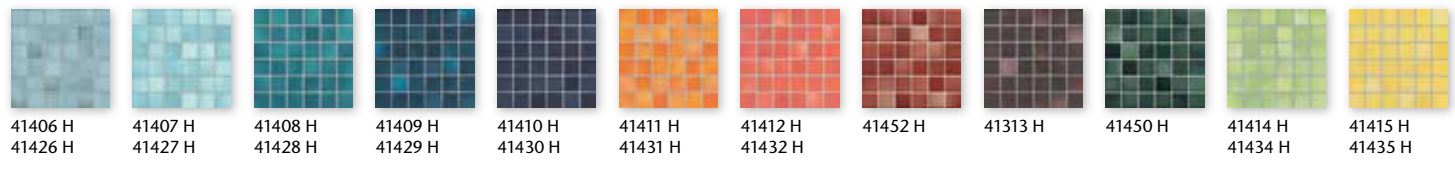
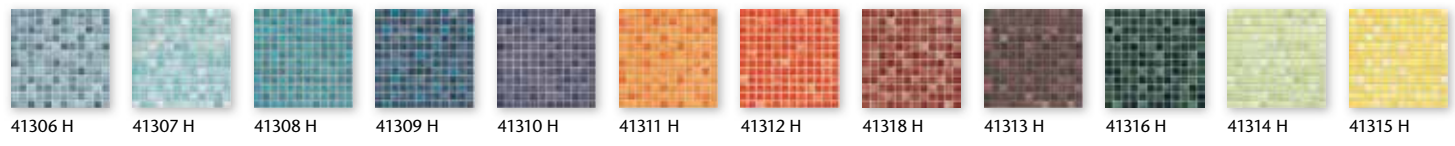
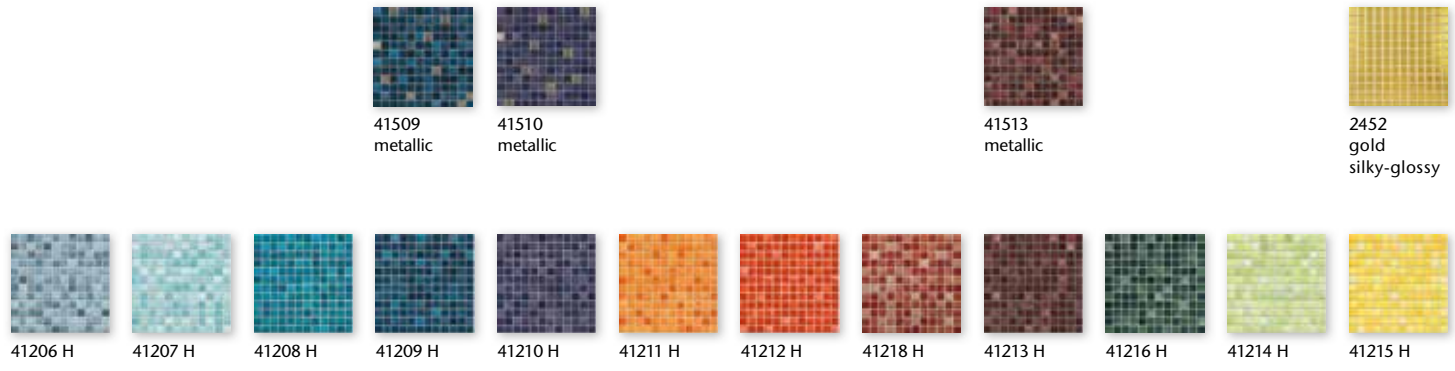

Mosaic 2.5 x 2.5 cm, 1 x 1 in



Mosaic sheet 30 x 30 cm, 12 x 12 in snow white, smooth,
Mosaic sheet 30 x 30 cm, 12 x 12 in snow white, smooth, R10/B

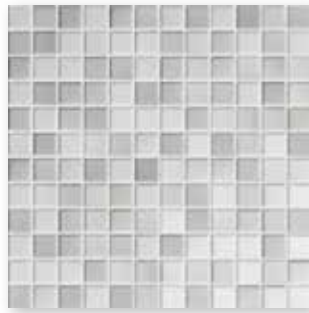

Mosaic sheet 30 x 30 cm, 12 x 12 in warm-grey-mix, smooth,
Mosaic sheet 30 x 30 cm, 12 x 12 in warm-grey-mix, smooth, R10/B



Mosaic sheet 30 x 30 cm, 12 x 12 in desert sand-mix, smooth,
Mosaic sheet 30 x 30 cm, 12 x 12 in desert sand-mix, smooth, R10/B

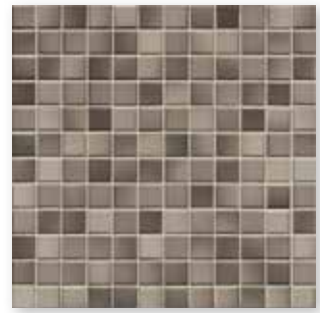

Mosaic sheet 30 x 30 cm, 12 x 12 in taupe-mix, smooth,
Mosaic sheet 30 x 30 cm, 12 x 12 in taupe-mix, smooth, R10/B



Mosaic sheet 30 x 30 cm, 12 x 12 in white grey-mix, smooth,
Mosaic sheet 30 x 30 cm, 12 x 12 in white grey-mix, smooth, R10/B

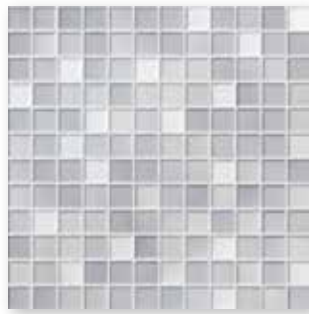

Mosaic sheet 30 x 30 cm, 12 x 12 in silver grey-mix, smooth,
Mosaic sheet 30 x 30 cm, 12 x 12 in silver grey-mix, smooth, R10/B

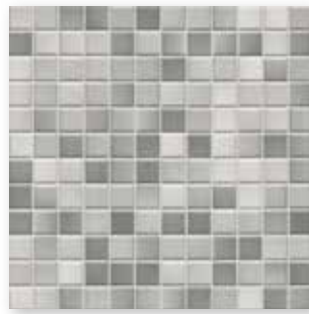

Mosaic sheet 30 x 30 cm, 12 x 12 in light grey-mix, smooth,
Mosaic sheet 30 x 30 cm, 12 x 12 in light grey-mix, smooth, R10/B

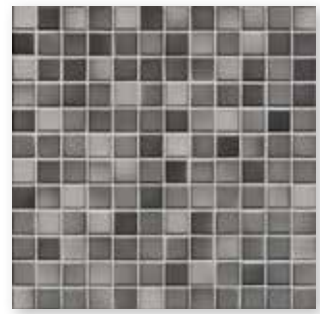

Mosaic sheet 30 x 30 cm, 12 x 12 in medium grey-mix, smooth,
Mosaic sheet 30 x 30 cm, 12 x 12 in medium grey-mix, smooth, R10/B

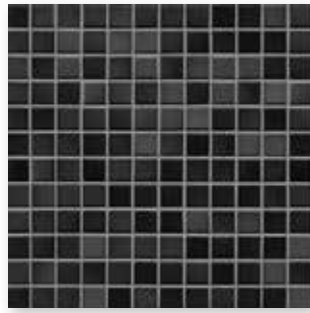

Mosaic sheet 30 x 30 cm, 12 x 12 in midnight black-mix, smooth,
Mosaic sheet 30 x 30 cm, 12 x 12 in midnight black-mix, smooth, R10/B



Mosaic sheet 30 x 30 cm, 12 x 12 in graphite black-mix, smooth,
Mosaic sheet 30 x 30 cm, 12 x 12 in graphite black-mix, smooth, R10/B



Mosaic sheet 30 x 30 cm, 12 x 12 in deep blue-mix, smooth,
Mosaic sheet 30 x 30 cm, 12 x 12 in deep blue-mix, smooth, R10/B

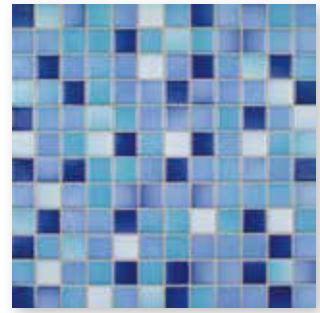

Mosaic sheet 30 x 30 cm, 12 x 12 in caribbean-blue-mix, smooth,
Mosaic sheet 30 x 30 cm, 12 x 12 in caribbean-blue-mix, smooth, R10/B

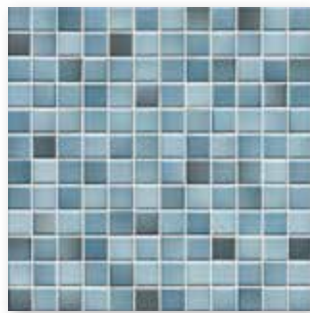

Mosaic sheet 30 x 30 cm, 12 x 12 in denim blue-mix, smooth,
Mosaic sheet 30 x 30 cm, 12 x 12 in denim blue-mix, smooth, R10/B

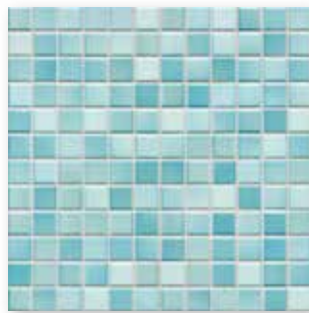

Mosaic sheet 30 x 30 cm, 12 x 12 in light blue-mix, smooth,
Mosaic sheet 30 x 30 cm, 12 x 12 in light blue-mix, smooth, R10/B

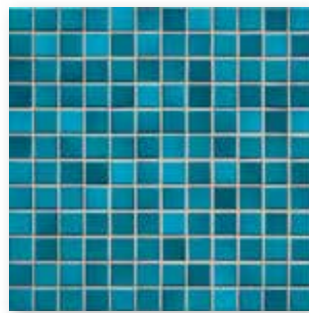

Mosaic sheet 30 x 30 cm, 12 x 12 in pacific blue-mix, smooth,
Mosaic sheet 30 x 30 cm, 12 x 12 in pacific blue-mix, smooth, R10/B

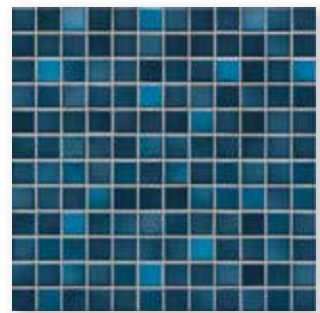

Mosaic sheet 30 x 30 cm, 12 x 12 in midnight blue-mix, smooth,
Mosaic sheet 30 x 30 cm, 12 x 12 in midnight blue-mix, smooth, R10/B

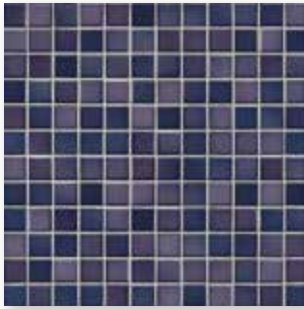

Mosaic sheet 30 x 30 cm, 12 x 12 in
vivid violet-mix, smooth,
Mosaic sheet 30 x 30 cm, 12 x 12 in
vivid violet-mix, smooth, R10/B

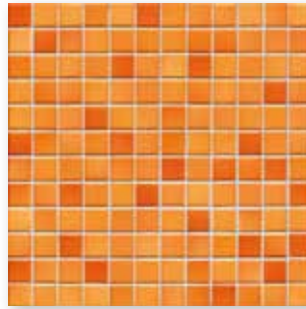

Mosaic sheet 30 x 30 cm, 12 x 12 in
sunset-orange-mix, smooth,
Mosaic sheet 30 x 30 cm, 12 x 12 in
sunset-orange-mix, smooth, R10/B

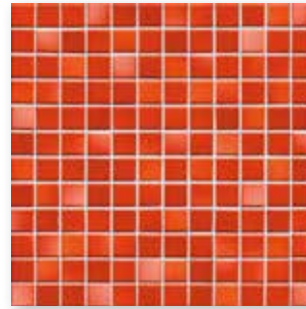

Mosaic sheet 30 x 30 cm, 12 x 12 in
coral red-mix, smooth,
Mosaic sheet 30 x 30 cm, 12 x 12 in
coral red-mix, smooth, R10/B

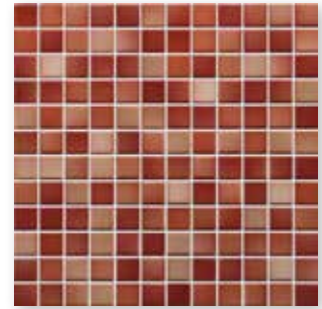

Mosaic sheet 30 x 30 cm, 12 x 12 in
brick red-mix, smooth,
Mosaic sheet 30 x 30 cm, 12 x 12 in
brick red-mix, smooth, R10/B

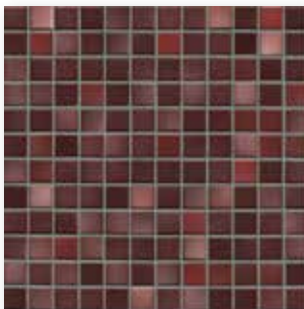

Mosaic sheet 30 x 30 cm, 12 x 12 in
mystic-red-mix, smooth,
Mosaic sheet 30 x 30 cm, 12 x 12 in
mystic-red-mix, smooth, R10/B



Mosaic sheet 30 x 30 cm, 12 x 12 in
forest green-mix, smooth,
Mosaic sheet 30 x 30 cm, 12 x 12 in
forest green-mix, smooth, R10/B

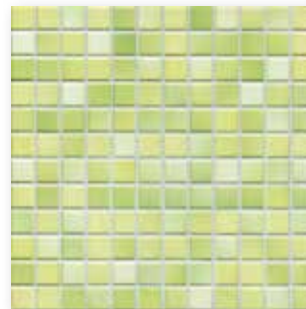

Mosaic sheet 30 x 30 cm, 12 x 12 in
lime green-mix, smooth,
Mosaic sheet 30 x 30 cm, 12 x 12 in
lime green-mix, smooth, R10/B

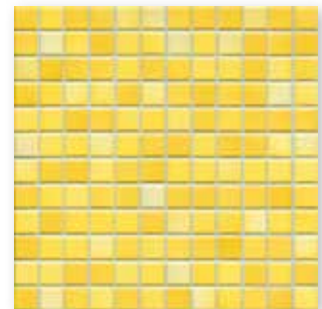

Mosaic sheet 30 x 30 cm, 12 x 12 in
sunshine yellow-mix, smooth,
Mosaic sheet 30 x 30 cm, 12 x 12 in
sunshine yellow-mix, smooth, R10/B

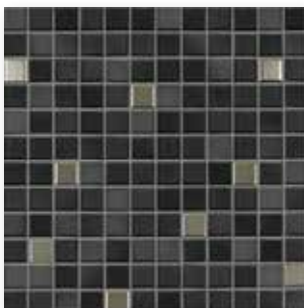

Mosaic sheet 30 x 30 cm, 12 x 12 in
midnight black-mix metallic, smooth

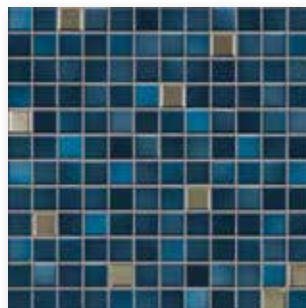

Mosaic sheet 30 x 30 cm, 12 x 12 in
midnight blue-mix metallic, smooth

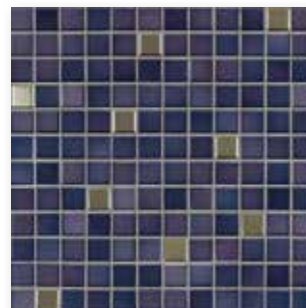

Mosaic sheet 30 x 30 cm, 12 x 12 in
vivid violet-mix metallic, smooth

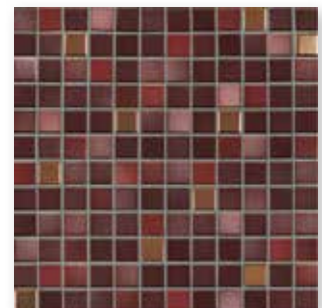

Mosaic sheet 30 x 30 cm, 12 x 12 in
mystic red-mix metallic, smooth

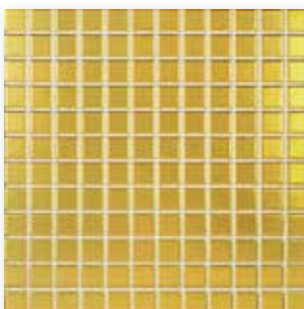

Mosaic sheet 30 x 30 cm, 12 x 12 in
gold, smooth*

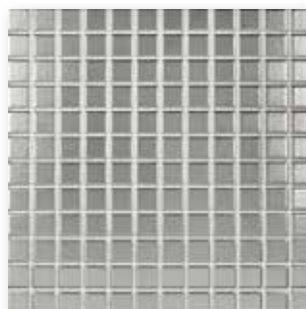

Mosaic sheet 30 x 30 cm, 12 x 12 in
platin, smooth*

* To prevent the abrasion of the surface coating, laying on the floor or exposure to any comparable stress must be absolutely avoided.



Mosaics glued thermoplastically on back of AGROB BUCHTAL can be used not only in dry zones but also without any problems in underwater areas (e.g. swimming pools/whirlpools) as well as in permanently wet areas.

Indoor swimming pool, Oberuzwil, Switzerland / Architect: Hunziker Betatech AG / Photo: Adriano Faragulo



Color gradient
2.5 x 2.5 cm, 1 x 1 in

More examples

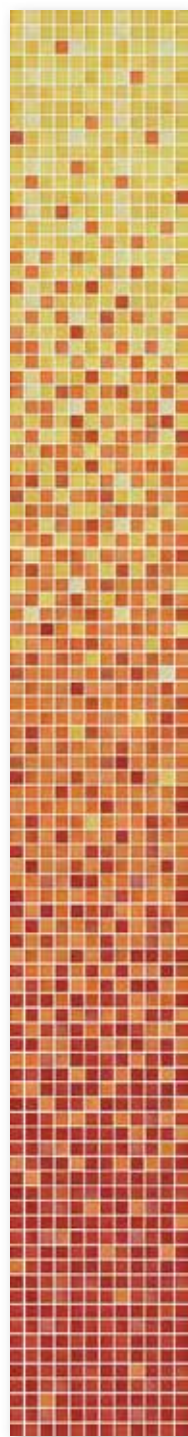

The colors of Fresh can be randomly replaced in the standard color gradient without extra charge. We will be pleased to check an individual design of color gradients with regard to dimensions and color combinations as customized production.

production size without external joint:
297 x 2376 x 6.5 mm

41520H
aqua glossy

Do you already know our Mosaic Designer at our website
www.agrob-buchtal.com?

There, you will have the possibility of designing your individual color gradients, mosaic compositions and the laying of pictures.



R10/B R11/C



Mosaic 5 x 5 cm, 2 x 2 in, non-slip



Mosaic sheet 30 x 30 cm, 12 x 12 in snow white, smooth, R10/B,
Mosaic sheet 30 x 30 cm, 12 x 12 in snow white, smooth, R11/C



Mosaic sheet 30 x 30 cm, 12 x 12 in warm grey-mix, smooth, R10/B,
Mosaic sheet 30 x 30 cm, 12 x 12 in warm grey-mix, smooth, R11/C



Mosaic sheet 30 x 30 cm, 12 x 12 in desert sand-mix, smooth, R10/B,
Mosaic sheet 30 x 30 cm, 12 x 12 in desert sand-mix, smooth, R11/C



Mosaic sheet 30 x 30 cm, 12 x 12 in taupe-mix, smooth, R10/B,
Mosaic sheet 30 x 30 cm, 12 x 12 in taupe-mix, smooth, R11/C



Mosaic sheet 30 x 30 cm, 12 x 12 in white grey-mix, smooth, R10/B



Mosaic sheet 30 x 30 cm, 12 x 12 in silver grey-mix, smooth, R10/B



Mosaic sheet 30 x 30 cm, 12 x 12 in light grey-mix, smooth, R10/B,
Mosaic sheet 30 x 30 cm, 12 x 12 in light grey-mix, smooth, R11/C



Mosaic sheet 30 x 30 cm, 12 x 12 in medium grey-mix, smooth, R10/B,
Mosaic sheet 30 x 30 cm, 12 x 12 in medium grey-mix, smooth, R11/C



Mosaic sheet 30 x 30 cm, 12 x 12 in midnight black-mix, smooth, R10/B,
Mosaic sheet 30 x 30 cm, 12 x 12 in midnight black-mix, smooth, R11/C



Mosaic sheet 30 x 30 cm, 12 x 12 in graphite black-mix, smooth, R10/B



Mosaic sheet 30 x 30 cm, 12 x 12 in deep blue-mix, smooth, R10/B

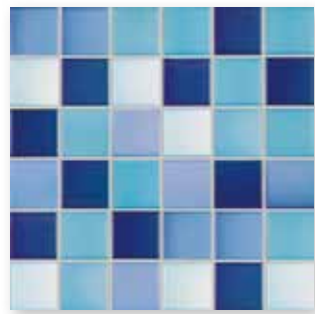

Mosaic sheet 30 x 30 cm, 12 x 12 in caribbean-blue-mix, smooth, R10/B



Mosaics glued thermoplastically on back of AGROB BUCHTAL can be used not only in dry zones but also without any problems in underwater areas (e.g. swimming pools/whirlpools) as well as in permanently wet areas (e.g. pool surrounds/showers).



Mosaic sheet 30 x 30 cm, 12 x 12 in denim blue-mix, smooth, R10/B,
Mosaic sheet 30 x 30 cm, 12 x 12 in denim blue-mix, smooth, R11/C



Mosaic sheet 30 x 30 cm, 12 x 12 in light blue-mix, smooth, R10/B,
Mosaic sheet 30 x 30 cm, 12 x 12 in light blue-mix, smooth, R11/C

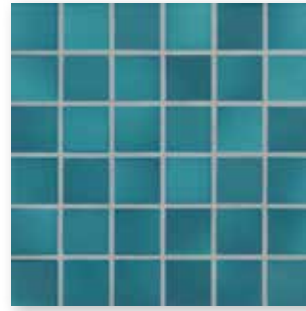

Mosaic sheet 30 x 30 cm, 12 x 12 in pacific blue-mix, smooth, R10/B,
Mosaic sheet 30 x 30 cm, 12 x 12 in pacific blue-mix, smooth, R11/C

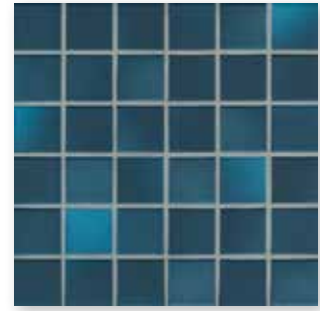

Mosaic sheet 30 x 30 cm, 12 x 12 in midnight blue-mix, smooth, R10/B,
Mosaic sheet 30 x 30 cm, 12 x 12 in midnight blue-mix, smooth, R11/C



Mosaic sheet 30 x 30 cm, 12 x 12 in vivid violet-mix, smooth, R10/B,
Mosaic sheet 30 x 30 cm, 12 x 12 in vivid violet-mix, smooth, R11/C

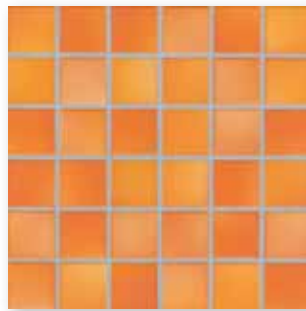

Mosaic sheet 30 x 30 cm, 12 x 12 in sunset orange-mix, smooth, R10/B,
Mosaic sheet 30 x 30 cm, 12 x 12 in sunset orange-mix, smooth, R11/C

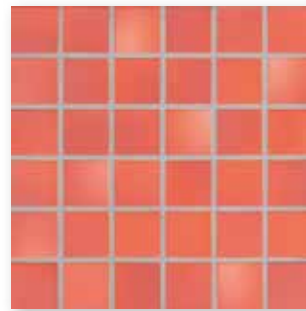

Mosaic sheet 30 x 30 cm, 12 x 12 in coral red-mix, smooth, R10/B,
Mosaic sheet 30 x 30 cm, 12 x 12 in coral red-mix, smooth, R11/C



Mosaic sheet 30 x 30 cm, 12 x 12 in brick red-mix, smooth, R10/B

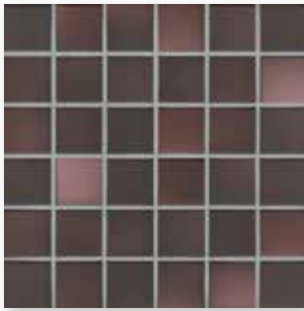

Mosaic sheet 30 x 30 cm, 12 x 12 in mystic red-mix, smooth, R10/B,
Mosaic sheet 30 x 30 cm, 12 x 12 in mystic red-mix, smooth, R11/C



Mosaic sheet 30 x 30 cm, 12 x 12 in forest green-mix, smooth, R10/B

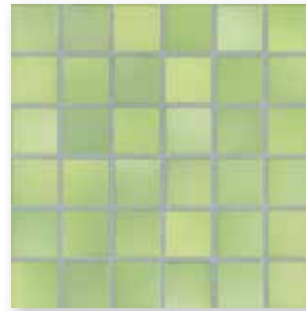

Mosaic sheet 30 x 30 cm, 12 x 12 in lime green-mix, smooth, R10/B,
Mosaic sheet 30 x 30 cm, 12 x 12 in lime green-mix, smooth, R11/C

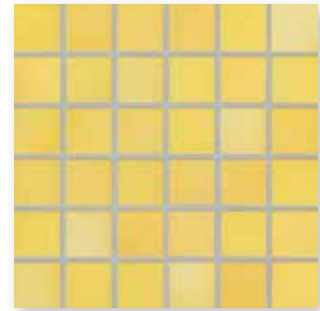

Mosaic sheet 30 x 30 cm, 12 x 12 in sunshine yellow-mix, smooth, R10/B,
Mosaic sheet 30 x 30 cm, 12 x 12 in sunshine yellow-mix, smooth, R11/C

Mosaic

Color Gradient¹

2.5 x 2.5 cm



2.5 x 2.5 cm



Sheet: 297 x 297 mm

Sheet: 297 x 297 mm

Nom. dim. - cm/in	2,5 x 2,5 / 1 x 1	2,5 x 2,5 / 1 x 1					
Work size	23 x 23 x 6.5 mm	23 x 23 x 6.5 mm					
Surface	smooth, glossy	smooth, glossy					
m ² - pieces	11 sheets	11 sheets					
m ² - kg	12.100						
Bundle - pieces	11 sheets	8 sheets					
Bundle - m ²	1.000	0.800					
Bundle - kg	12.100	8.800					
Pallet - m ²	48.000						
Pallet - kg	580.800						
Product standard	Bib	Bib					
Slip resistance							
Stress group	1	1					
	3						
snow white <input type="checkbox"/>	41200H Price gr. A229 (m ²)						
desert sand-mix <input type="checkbox"/>	3 41201H Price gr. A229 (m ²)						
taupe-mix <input type="checkbox"/>	3 41202H Price gr. A229 (m ²)						
light grey-mix <input type="checkbox"/>	3 41203H Price gr. A229 (m ²)						
medium grey-mix <input type="checkbox"/>	3 41204H Price gr. A229 (m ²)						
midnight black-mix <input type="checkbox"/>	2 41205H Price gr. A229 (m ²)						
denim blue-mix <input type="checkbox"/>	3 41206H Price gr. A250 (m ²)						
light blue-mix <input type="checkbox"/>	3 41207H Price gr. A250 (m ²)						
pacific blue-mix <input type="checkbox"/>	3 41208H Price gr. A250 (m ²)						
midnight blue-mix <input type="checkbox"/>	3 41209H Price gr. A250 (m ²)						
vivid violet-mix <input type="checkbox"/>	2 41210H Price gr. A250 (m ²)						
sunset orange-mix <input type="checkbox"/>	3 41211H Price gr. A250 (m ²)						
coral red-mix <input type="checkbox"/>	3 41212H Price gr. A250 (m ²)						
mystic red-mix <input type="checkbox"/>	2 41213H Price gr. A250 (m ²)						
lime green-mix <input type="checkbox"/>	3 41214H Price gr. A250 (m ²)						
sunshine <input type="checkbox"/>	4 41215H Price gr. A250 (m ²)						
yellow-mix <input type="checkbox"/>							
aqua <input type="checkbox"/>	3	41520H					
glossy <input type="checkbox"/>		Price gr. A750 (pce.)					



¹ Work size without external joint: 297 x 2376 mm

The indicated price refers to the color gradient = 8 sheets

Color gradients can be designed individually. We would be delighted to examine the possibility of such customized production in individual cases.

Do you already know our Mosaic Designer at our website www.agrob-buchtal.com?

There, you will have the possibility of designing your individual color gradients, mosaic compositions and the laying of pictures.

Mosaic

2.5 x 2.5 cm

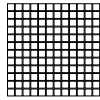

5 x 5 cm

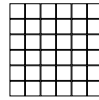

5 x 5 cm

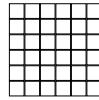

Sheet: 297 x 297 mm

Sheet: 297 x 297 mm

Sheet: 297 x 297 mm



Nom. dim. - cm/in	2.5 x 2.5 / 1 x 1	5 x 5 / 2 x 2	5 x 5 / 2 x 2			
Work size	23 x 23 x 6.5 mm	47 x 47 x 6.5 mm	47 x 47 x 6.5 mm			
Surface	smooth, matt	smooth, matt	smooth, matt			
m ² - pieces	11 sheets	11 sheets	11 sheets			
m ² - kg	12.100	12.331	12.331			
Bundle - pieces	11 sheets	11 sheets	11 sheets			
Bundle - m ²	1.000	1.000	1.000			
Bundle - kg	12.100	12.331	12.331			
Pallet - m ²	48.000	64.000	64.000			
Pallet - kg	580.800	789.184	789.184			
Product standard	Blb	Blb	Blb			
Slip resistance	R10/B	R10/B	R11/C			
Stress group	1	1	1			
	4					
snow white	41300H Price gr. A238 (m ²)	41400H-73 Price gr. A196 (m ²)	41420H Price gr. A211 (m ²)			
desert sand-mix	41301H Price gr. A238 (m ²)	41401H-73 Price gr. A196 (m ²)	41421H Price gr. A211 (m ²)			
taupe-mix	3 41302H Price gr. A238 (m ²)	41402H-73 Price gr. A196 (m ²)	41422H Price gr. A211 (m ²)			
light grey-mix	4 41303H Price gr. A238 (m ²)	41403H-73 Price gr. A196 (m ²)	41423H Price gr. A211 (m ²)			
medium grey-mix	4 41304H Price gr. A238 (m ²)	41404H-73 Price gr. A196 (m ²)	41424H Price gr. A211 (m ²)			
midnight black-mix	3 41305H Price gr. A238 (m ²)	41405H-73 Price gr. A196 (m ²)	41425H Price gr. A211 (m ²)			
denim blue-mix	3 41306H Price gr. A259 (m ²)	41406H Price gr. A217 (m ²)	41426H Price gr. A229 (m ²)			
light blue-mix	3 41307H Price gr. A259 (m ²)	41407H Price gr. A217 (m ²)	41427H Price gr. A229 (m ²)			
pacific blue-mix	4 41308H Price gr. A259 (m ²)	41408H Price gr. A217 (m ²)	41428H Price gr. A229 (m ²)			
midnight blue-mix	3 41309H Price gr. A259 (m ²)	41409H Price gr. A217 (m ²)	41429H Price gr. A229 (m ²)			
vivid violet-mix	3 41310H Price gr. A259 (m ²)	41410H Price gr. A217 (m ²)	41430H Price gr. A229 (m ²)			
sunset orange-mix	4 41311H Price gr. A259 (m ²)	41411H Price gr. A217 (m ²)	41431H Price gr. A229 (m ²)			
coral red-mix	3 41312H Price gr. A259 (m ²)	41412H Price gr. A217 (m ²)	41432H Price gr. A229 (m ²)			
mystic red-mix	3 41313H Price gr. A259 (m ²)	41413H Price gr. A217 (m ²)	41433H Price gr. A229 (m ²)			
lime green-mix	3 41314H Price gr. A259 (m ²)	41414H Price gr. A217 (m ²)	41434H Price gr. A229 (m ²)			
sunshine yellow-mix	4 41315H Price gr. A259 (m ²)	41415H Price gr. A217 (m ²)	41435H Price gr. A229 (m ²)			
forest green mix	3 41316H Price gr. A259 (m ²)	41450H Price gr. A217 (m ²)				
deep blue mix	2 41317H Price gr. A259 (m ²)	41451H Price gr. A217 (m ²)				
brick red mix	3 41318H Price gr. A259 (m ²)	41452H Price gr. A217 (m ²)				
silver grey mix	4 41319H Price gr. A259 (m ²)	41453H Price gr. A217 (m ²)				
warm grey mix	4 41320H Price gr. A259 (m ²)	41454H Price gr. A217 (m ²)				
white grey mix	3 41321H Price gr. A259 (m ²)	41455H Price gr. A217 (m ²)				
caribbean blue mix	4 41322H Price gr. A259 (m ²)	41456H Price gr. A217 (m ²)				
graphite black mix	3 41323H Price gr. A259 (m ²)	41457H Price gr. A217 (m ²)				

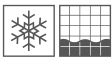



Indoor swimming pool, Höxter, Germany / Architect: Hooper Architects / Series: Fresh, Quarzit / Photo: Jochen Stüber







Fine and round

The perfect answer to the trend towards soft, rounded designs is the mosaic Loop. It is available in 15 finely nuanced, high-gloss colors, six of which are also available in a matt, slip-resistant version. This extends the range of applications to showers and other wet areas. In addition to the mosaic with a 2 cm diameter, a 1 cm variant is also available, which conveys a particularly filigree and elegant impression. In contrasting colors, it is also suitable for pictograms, letters, arrows and QR codes. Decorative elements made of square and round mosaic tiles and the Ocean decor with undulating color gradient round off the series.

Alster-Schwimmhalle, Hamburg, Germany / Architect: gmp Architekten, Hamburg / Series: Loop, Chroma / Photo: Jochen Stüber

Mosaic Ø 1 cm, Ø 3/8 in

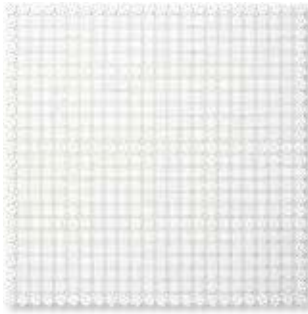

Mosaic sheet 30 x 30 cm, 12 x 12 in
arctic white glossy, smooth

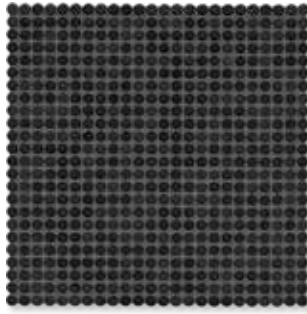

Mosaic sheet 30 x 30 cm, 12 x 12 in
night black glossy, smooth



Mosaic sheet 30 x 30 cm, 12 x 12 in
light ivory glossy, smooth



Mosaic sheet 30 x 30 cm, 12 x 12 in
ivory glossy, smooth



Mosaic sheet 30 x 30 cm, 12 x 12 in
light diamond grey glossy, smooth



Mosaic sheet 30 x 30 cm, 12 x 12 in
diamond grey glossy, smooth

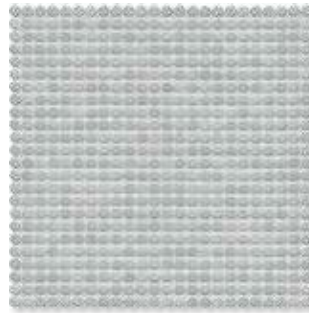

Mosaic sheet 30 x 30 cm, 12 x 12 in
denim glossy, smooth



Mosaic sheet 30 x 30 cm, 12 x 12 in
light aqua blue glossy, smooth



Mosaic sheet 30 x 30 cm, 12 x 12 in
aqua blue glossy, smooth

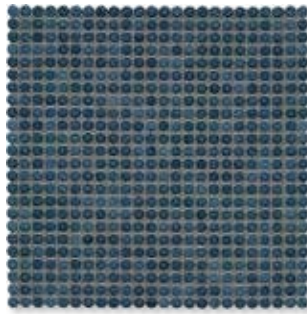

Mosaic sheet 30 x 30 cm, 12 x 12 in
steel blue glossy, smooth

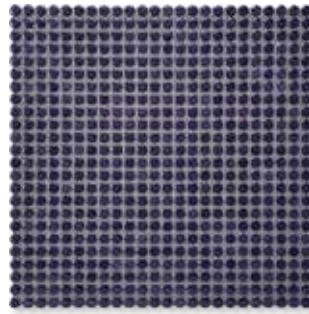

Mosaic sheet 30 x 30 cm, 12 x 12 in
dark violet glossy, smooth



Mosaic sheet 30 x 30 cm, 12 x 12 in
sea green glossy, smooth



Mosaic sheet 30 x 30 cm, 12 x 12 in
coral-red glossy, smooth

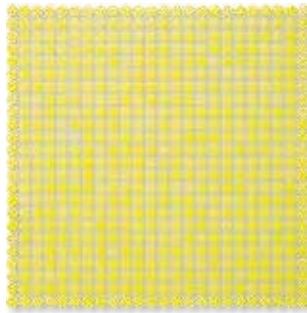

Mosaic sheet 30 x 30 cm, 12 x 12 in
lemon-yellow glossy, smooth

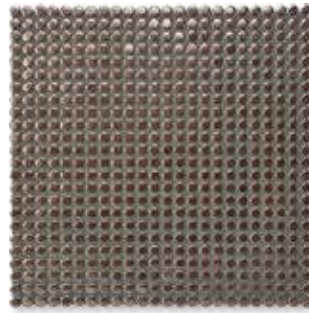

Mosaic sheet 30 x 30 cm, 12 x 12 in
bronze-metallic glossy, smooth

The products depicted can also be manufactured in other colors. We would be delighted to examine the possibility of such customized production in individual cases.

Mosaic 1 x 1 cm / Ø 1 cm, 3/8 x 3/8 in / Ø 3/8 in

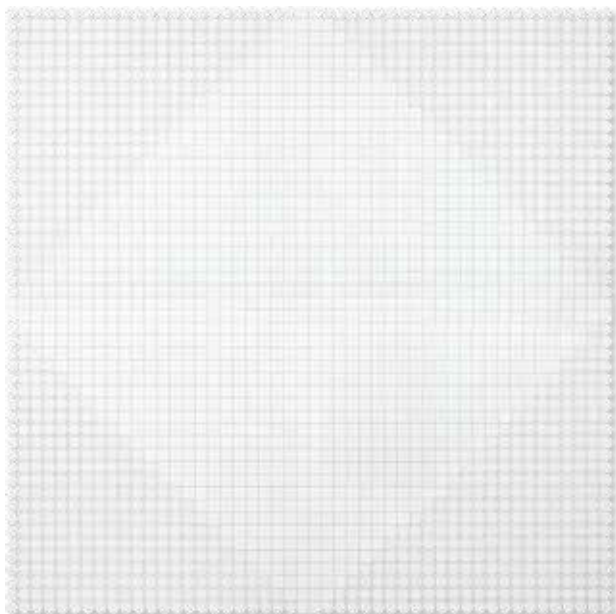

Mosaic sheet 30 x 30 cm, Triangle, arctic white glossy, smooth

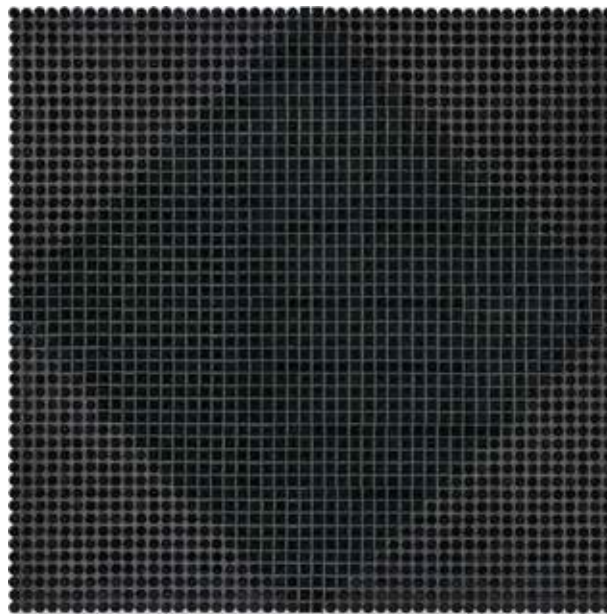

Mosaic sheet 30 x 30 cm, Triangle, night black glossy, smooth

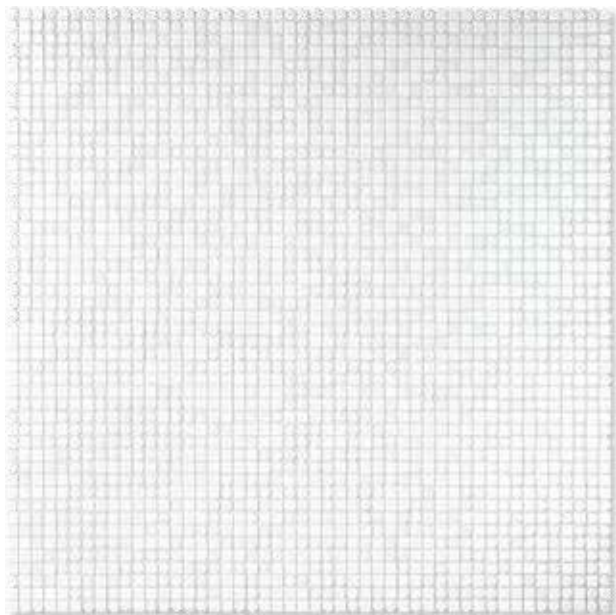

Mosaic sheet 30 x 30 cm, Random Mix, arctic white glossy, smooth

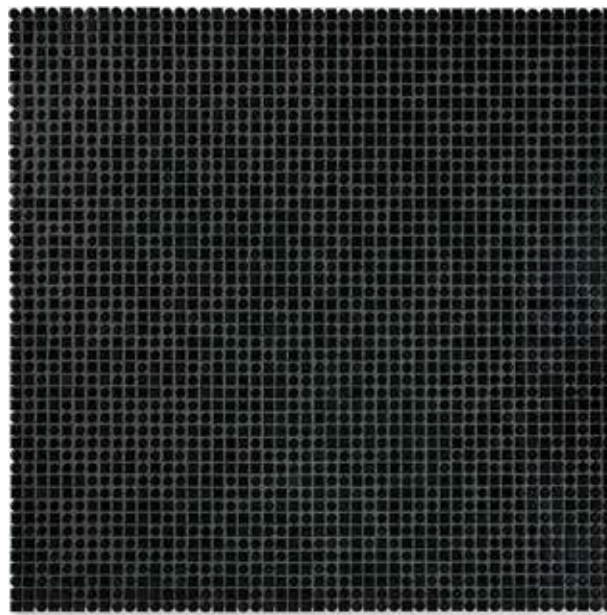

Mosaic sheet 30 x 30 cm, Random Mix, night black glossy, smooth

Production size without external joint 632 x 632 x 6.5 mm



Mosaics glued thermoplastically on back of AGROB BUCHTAL can be used not only in dry zones but also without any problems in underwater areas (e.g. swimming pools/whirlpools) as well as in permanently wet areas.

Mosaic 1 x 1 cm / Ø 1 cm, 3/8 x 3/8 in / Ø 3/8 in

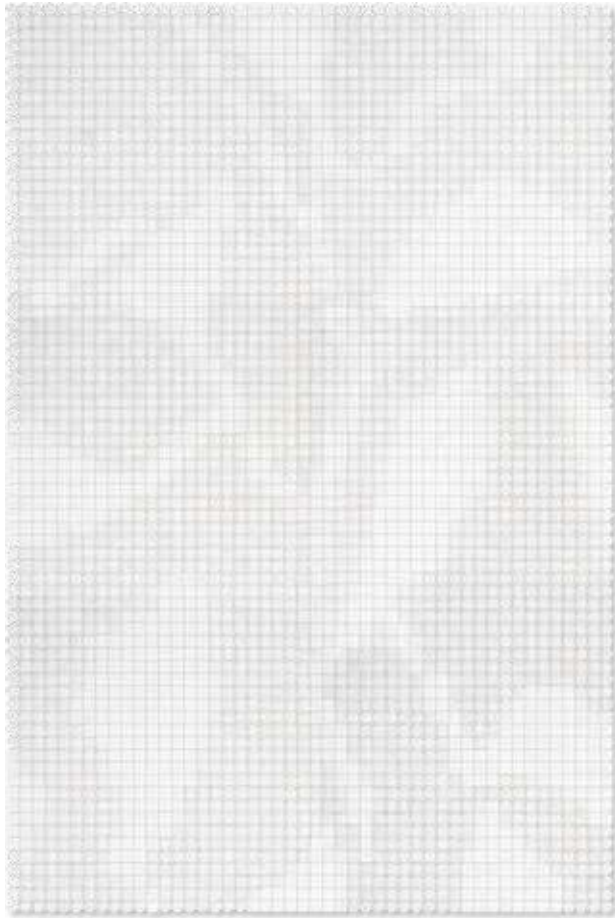

Mosaic sheet 30 x 30 cm, Leaves, arctic white glossy, smooth

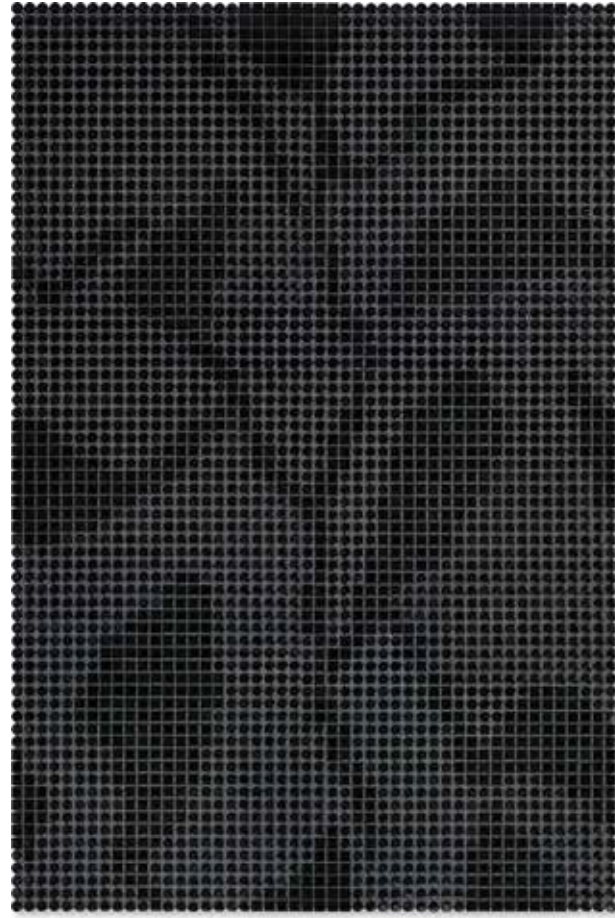

Mosaic sheet 30 x 30 cm, Leaves, night black glossy, smooth

Production size without external joint 632 x 948 x 6.5 mm



Mosaics glued thermoplastically on back of AGROB BUCHTAL can be used not only in dry zones but also without any problems in underwater areas (e.g. swimming pools/whirlpools) as well as in permanently wet areas.

Color gradient
Ø 1 cm, Ø 3/8 in

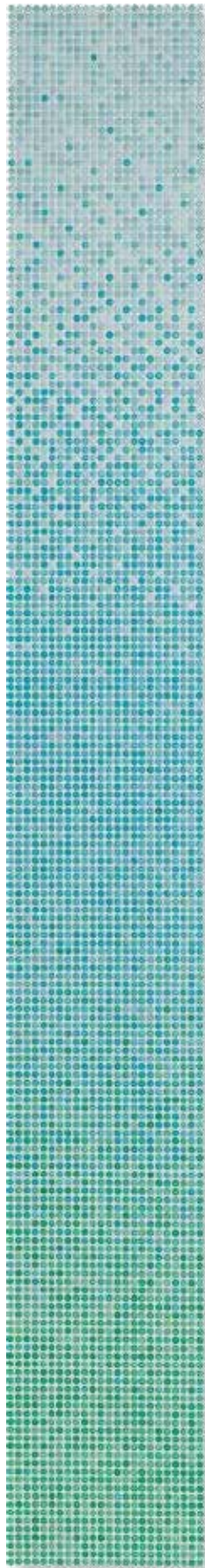

ocean glossy

Color gradient
Ø 2 cm, Ø 6/8 in



ocean glossy

More examples

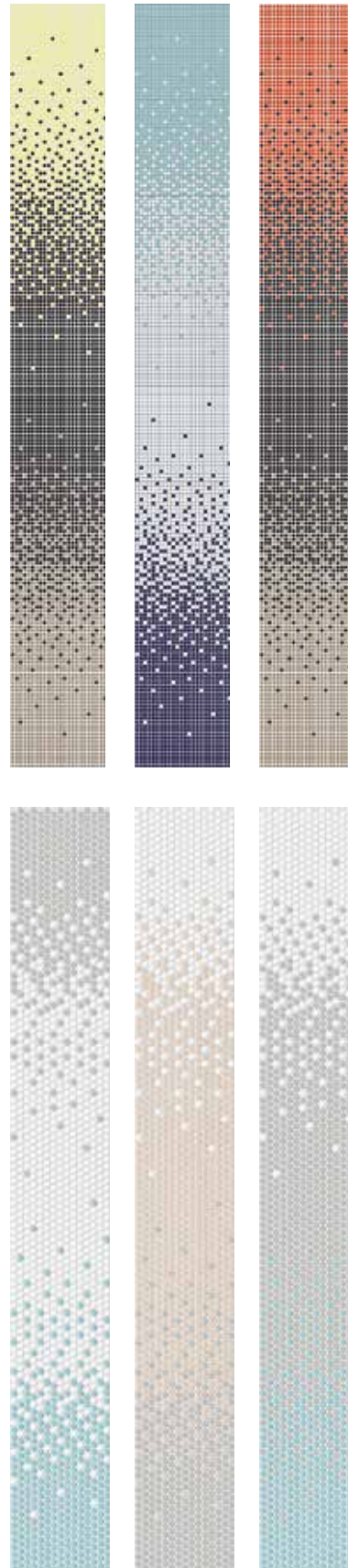

production size without external joint
314 x 2528 x 6.5 mm

The colors of Loop can be randomly replaced in the standard color gradient without extra charge. We will be pleased to check an individual design of color gradients with regard to dimensions and color combinations as customized production.

Do you already know our Mosaic Designer at our website www.agrob-buchtal.com?

There, you will have the possibility of designing your individual color gradients, mosaic compositions and the laying of pictures.

Mosaic Ø 2 cm, Ø 6/8 in



Mosaic sheet 32 x 32 cm, 12.8 x 12.8 in arctic white glossy, smooth
Mosaic sheet 32 x 32 cm, 12.8 x 12.8 in arctic white, smooth, R10/B



Mosaic sheet 32 x 32 cm, 12.8 x 12.8 in night black glossy, smooth
Mosaic sheet 32 x 32 cm, 12.8 x 12.8 in night black, smooth, R10/B



Mosaic sheet 32 x 32 cm, 12.8 x 12.8 in light ivory glossy, smooth
Mosaic sheet 32 x 32 cm, 12.8 x 12.8 in light ivory, smooth, R10/B



Mosaic sheet 32 x 32 cm, 12.8 x 12.8 in ivory glossy, smooth



Mosaic sheet 32 x 32 cm, 12.8 x 12.8 in light diamond grey glossy, smooth
Mosaic sheet 32 x 32 cm, 12.8 x 12.8 in light diamond grey, smooth, R10/B



Mosaic sheet 32 x 32 cm, 12.8 x 12.8 in diamond grey glossy, smooth



Mosaic sheet 32 x 32 cm, 12.8 x 12.8 in denim glossy, smooth



Mosaic sheet 32 x 32 cm, 12.8 x 12.8 in light aqua blue glossy, smooth
Mosaic sheet 32 x 32 cm, 12.8 x 12.8 in light aqua blue, smooth, R10/B



Mosaic sheet 32 x 32 cm, 12.8 x 12.8 in aqua blue glossy, smooth
Mosaic sheet 32 x 32 cm, 12.8 x 12.8 in aqua blue, smooth, R10/B



Mosaic sheet 32 x 32 cm, 12.8 x 12.8 in steel blue glossy, smooth



Mosaic sheet 32 x 32 cm, 12.8 x 12.8 in dark violet glossy, smooth



Mosaic sheet 32 x 32 cm, 12.8 x 12.8 in sea green glossy, smooth
Mosaic sheet 32 x 32 cm, 12.8 x 12.8 in sea green, smooth, R10/B



Mosaic sheet 32 x 32 cm, 12.8 x 12.8 in coral-red glossy, smooth



Mosaic sheet 32 x 32 cm, 12.8 x 12.8 in lemon-yellow glossy, smooth



Mosaic sheet 32 x 32 cm, 12.8 x 12.8 in bronze-metallic glossy, smooth



Mosaics glued thermoplastically on back of AGROB BUCHTAL can be used not only in dry zones but also without any problems in underwater areas (e.g. swimming pools/whirlpools) as well as in permanently wet areas.

Mosaic

Color Gradient

Ø 1 cm

Ø 1 cm¹

Ø 1 cm¹

Ø 1 cm²

Ø 2 cm

Ø 1 cm^{3/5}

Ø 2 cm^{4/5}

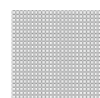
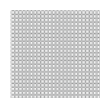

Sheet: 316 x 316 mm	Triangle Sheet: 316 x 316 mm	Random Mix Sheet: 316 x 316 mm	Leaves Sheet: 316 x 316 mm	Sheet: 326 x 316 mm	Sheet: 316 x 316 mm	Sheet: 326 x 316 mm	Stress group	Nom. dim. - cm/in
Ø 1 / 3/8	Ø 1 / 3/8	Ø 1 / 3/8	Ø 1 / 3/8	Ø 2 / 6/8	Ø 1 / Ø 3/8	Ø 2 / 6/8		
Ø 12 x 6,5 mm	Ø 12 x 6,5 mm	Ø 12 x 6,5 mm	Ø 12 x 6,5 mm	Ø 22.3 x 6,5 mm	Ø 12 x 6.5 mm	Ø 22,3 x 6.5 mm		Surface
smooth, glossy	smooth, glossy	smooth, glossy	smooth, glossy	smooth, glossy	smooth, glossy	smooth, glossy		m ² - pieces
10 sheets				10 sheets				m ² - kg
9,720				11,600				Bundle - pieces
10 sheets	4 sheets	4 sheets	6 sheets	10 sheets	8 sheets	8 sheets		Bundle - m ²
1.000	0.400	0.400	0.600	1.000	0.800	0.800		Bundle - kg
9.720	4.320	4.320	6.480	11.600	7.776	8.872		Pallet - m ²
24.000				48.000				Pallet - kg
233.280				556.800				Product standard
Blb	Bib	Bib	Bib	Bib	Bib	Bib		
40000H	40050H	40052H	40054H	40020H			3	arctic white
Price gr. A382 (m ²)	Price gr. A698 (Set)	Price gr. A698 (Set)	Price gr. A791 (Set)	Price gr. A304 (m ²)				glossy <input type="checkbox"/> V2
40001H	40051H	40053H	40055H	40021H			2	night black
Price gr. A382 (m ²)	Price gr. A698 (Set)	Price gr. A698 (Set)	Price gr. A791 (Set)	Price gr. A304 (m ²)				glossy <input type="checkbox"/> V2
40002H				40022H			3	light ivory
Price gr. A382 (m ²)				Price gr. A304 (m ²)				glossy <input type="checkbox"/> V2
40003H				40023H			3	ivory
Price gr. A382 (m ²)				Price gr. A304 (m ²)				glossy <input type="checkbox"/> V2
40004H				40024H			3	light diamond grey
Price gr. A382 (m ²)				Price gr. A304 (m ²)				glossy <input type="checkbox"/> V2
40005H				40025H			2	diamond grey
Price gr. A382 (m ²)				Price gr. A304 (m ²)				glossy <input type="checkbox"/> V2
40006H				40026H			3	denim
Price gr. A382 (m ²)				Price gr. A304 (m ²)				glossy <input type="checkbox"/> V2
40007H				40027H			3	light aqua blue
Price gr. A382 (m ²)				Price gr. A304 (m ²)				glossy <input type="checkbox"/> V2
40008H				40028H			2	aqua blue
Price gr. A382 (m ²)				Price gr. A304 (m ²)				glossy <input type="checkbox"/> V2
40009H				40029H			2	steel blue
Price gr. A382 (m ²)				Price gr. A304 (m ²)				glossy <input type="checkbox"/> V2
40010H				40030H			2	dark violet
Price gr. A382 (m ²)				Price gr. A304 (m ²)				glossy <input type="checkbox"/> V2
40011H				40031H			3	sea green
Price gr. A382 (m ²)				Price gr. A304 (m ²)				glossy <input type="checkbox"/> V2
40012H				40032H			2	coral-red
Price gr. A382 (m ²)				Price gr. A304 (m ²)				glossy <input type="checkbox"/> V2
40013H				40033H			3	lemon-yellow
Price gr. A382 (m ²)				Price gr. A304 (m ²)				glossy <input type="checkbox"/> V2
40014 ^{6/7}				40034 ^{6/7}			1	bronze-metallic
Price gr. A385 (m ²)				Price gr. A346 (m ²)				<input type="checkbox"/> V2
					40056H	40057H	2	ocean
					Price gr. A791 (pce.)	Price gr. A750 (pce.)		glossy <input type="checkbox"/> V2

¹ Work size without external joint: 632 x 632 x 6.5 mm
² Work size without external joint: 632 x 948 x 6.5 mm
³ Work size without external joint: 314 x 2528 x 6.5 mm
⁴ Work size without external joint: 326 x 2528 x 6.5 mm
⁵ The indicated price refers to the color gradient = 8 sheets
⁶ Not or only to a limited extent resistant to acids and alkalis.
⁷ without Hytect



Color gradients can be designed individually. We would be delighted to examine the possibility of such customized production in individual cases.

Do you already know our Mosaic Designer at our website www.agrob-buchtal.com?
There, you will have the possibility of designing your individual color gradients, mosaic compositions and the laying of pictures.

Mosaic

Ø 2 cm



Sheet: 326 x 316 mm

Nom. dim. - cm/in	Ø 2 / 6/8						
Work size	Ø 22.3 x 6.5 mm						
Surface	smooth, matt						
m ² - pieces	10 sheets						
m ² - kg	11.600						
Bundle - pieces	10 sheets						
Bundle - m ²	1.000						
Bundle - kg	11.600						
Pallet - m ²	48.000						
Pallet - kg	556.800						
Product standard	Blb						
Slip resistance	R10/B						
	4	40040H					
arctic white	V2	Price gr. A313 (m ²)					
	2	40041H					
night black	V2	Price gr. A313 (m ²)					
	4	40042H					
light ivory	V2	Price gr. A313 (m ²)					
	4	40044H					
light diamond grey	V2	Price gr. A313 (m ²)					
	4	40047H					
aqua blue light	V2	Price gr. A313 (m ²)					
	3	40048H					
aqua blue	V2	Price gr. A313 (m ²)					
	3	40071H					
sea green	V2	Price gr. A313 (m ²)					



The products depicted can also be manufactured in other colors.
We would be delighted to examine the possibility of such customized production in individual cases.

Wide range

In addition to the series Fresh and Loop presented here, AGROB BUCHTAL also offers other mosaic series for diverse architectural concepts. All information about this is included in the 2024 programme of delivery.



Amano

Delicately transparent colors and a glossy relief surface in the format of 2.5 x 2.5 cm characterize the series Amano.



Karl

Craftsmanship and original glazes interpreted in a creative manner – this is what the series Karl offers in two mosaic formats.



Marble & More

Small-scale aesthetics in marble look - this is Marble & More, which provides great design scope in six colors and the formats of 1 x 1 and 2.5 x 2.5 cm.

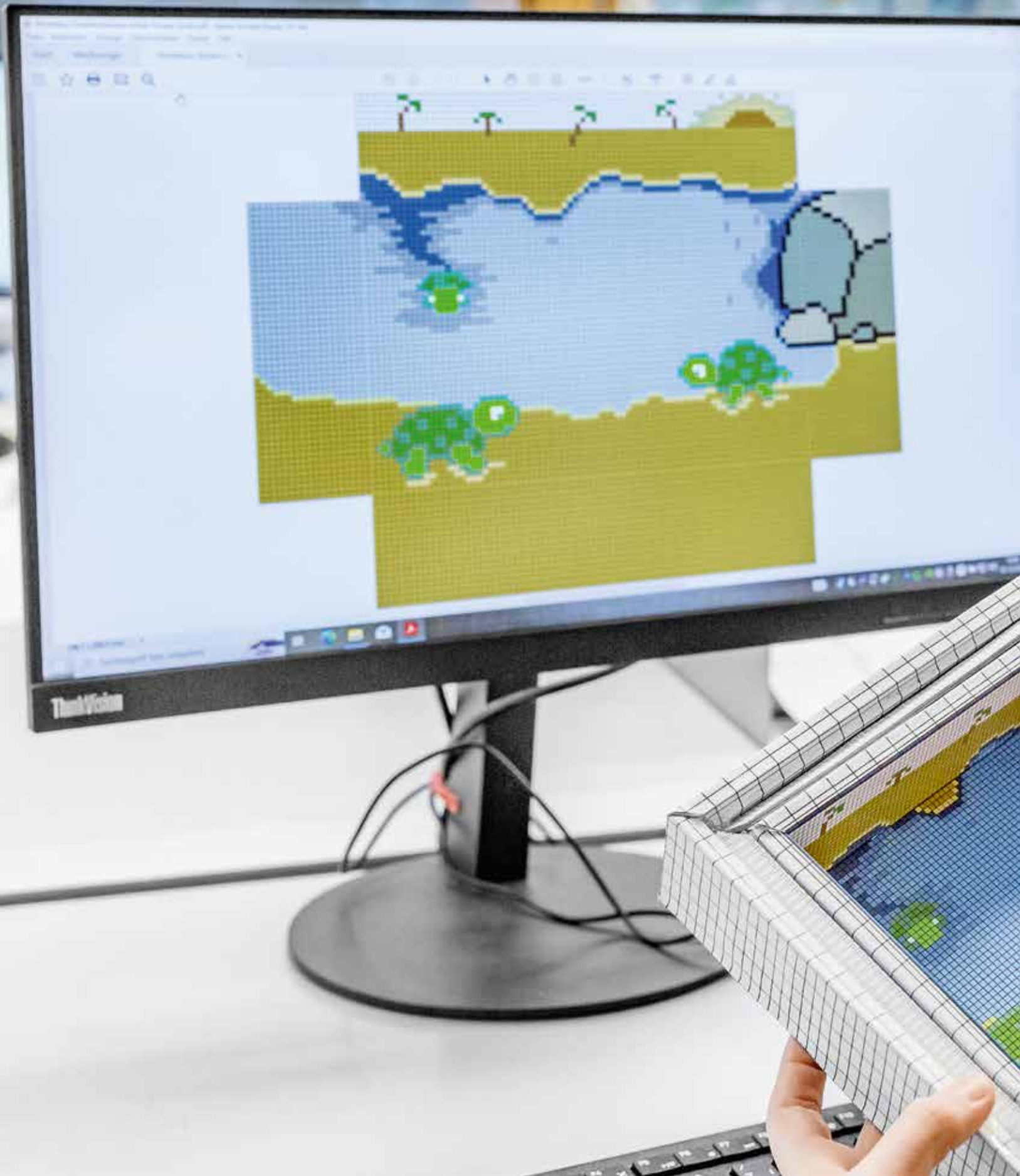

Planning and know-how



Swimming pool expertise in all project phases:

Whether at the research in the laboratory, in the in-house production or on location at the construction site – AGROB BUCHTAL uses its extensive expertise in the swimming pool sector to optimally adapt products and services to the requirements of architects, planners and swimming pool operators. In the service of architecture, AGROB BUCHTAL develops innovative technologies for surface upgrading, realizes individual custom-made products and provides support at routine planning tasks

In-house planning department

From professionals for professionals

For more than seven decades, AGROB BUCHTAL's in-house planning department has offered architects and planners competent advice and support at the planning and realization of their projects on request.

A committed team of qualified engineers, architects, designers, technicians and color experts ensures a quick and problem-free realization of individual construction projects. Since 1952, AGROB BUCHTAL has offered this service, which focuses above all on the requirements of architects. The range of services includes laying plans, determinations of quantities, detailed estimates, texts for bidding purposes or project-specific advice regarding application techniques. Upon request, a person to contact will be at your disposal on location.





Aquarama, Kristiansand, Norway
 Architect: Asplan Viak / Photo: Anders Martinsen

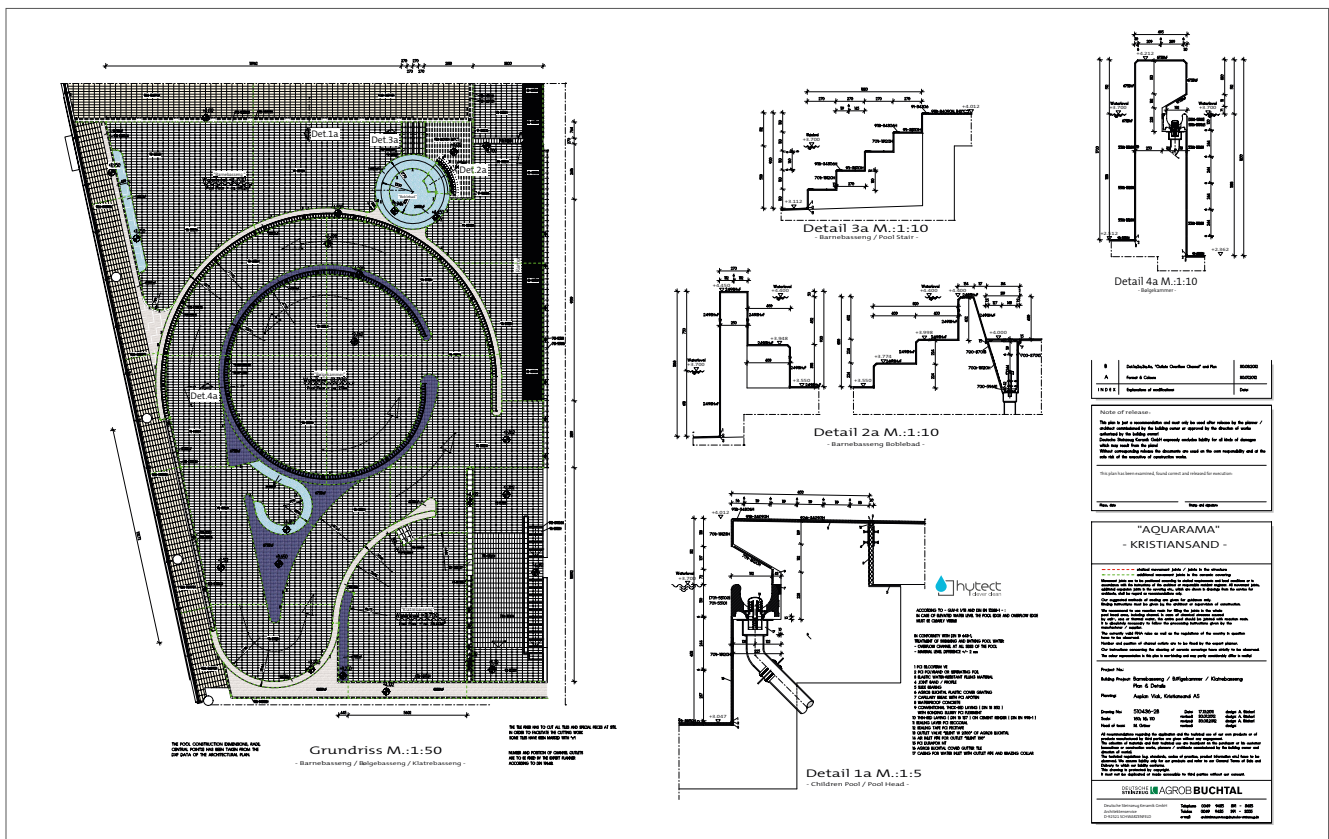



Slip resistance from A to C

Slip-resistant tiles for diverse applications are one of the core competences of AGROB BUCHTAL. This is particularly important in the swimming pool sector in order to prevent accidents caused by slipping.

The GRIP quality seal stands for the many years of experience of AGROB BUCHTAL in the field of slip resistance and is supervised by permanent external controls. The first slip-resistant tiles were established in the market by our company more than 80 years ago. Since then, they have been continuously further optimized through intensive research and development work. Today, the use of tiles in barefoot areas with a high risk of accident is subject to special legal regulations. The ceramic series of AGROB BUCHTAL meet these standards and are available in the valuation groups A and B, which are required for swimming pools. For the use under water – for example stairs and walk-through pools – some series also offer variants (decorated and mono-colored) in the slip-resistance category “C”.

From the laboratory into the swimming pool: accident prevention by tested safety

A micro-rough surface ensures a slip-resistant effect and an optimal hold of the soles of the feet in barefoot areas. In addition to high slip resistance, comfortable walking is also guaranteed in this way – without sliding or slipping. The different slip-resistance valuation groups are assigned to the right category by means of the test on the “inclined plane”. The tiles are always tested with different angles of inclination: the higher the angle, the higher the slip resistance.



Valuation group A

Barefoot passages and sanitary areas (nearly dry), individual and common dressing rooms, pool floors in non-swimmer areas if the water depth is more than 80 cm in the entire area, sauna and relaxation areas (nearly dry).

Valuation group B

Barefoot passages and sanitary areas, if not classified in group A, showers, steam baths, area of disinfecting spray facilities, pool surrounds, pool floors in non-swimmer areas if the water depth is less than 80 cm in certain areas, non-swimmer sections of wave-action pools, movable floors, paddling pools, ladders and stairs outside the pool area, accessible surfaces of diving platforms and diving boards, if not classified in group C, sauna and relaxation areas, if not classified in group A.

Valuation group C

Ladders and stairs leading into the water, stairs up to diving facilities and water slides, surfaces of diving platforms and diving boards over the length reserved for the diver (the slip-resistant surface of the diving platforms and diving boards must cover the front edge where the hands and the toes of the divers grip), walk-through pools, Kneipp basins, water-treading basins, inclined pool edge designs, ramps in pool surround areas.

Valuation groups	Angle of inclination	Barefoot area
A	$\geq 12^\circ$	
B	$\geq 18^\circ$	
C	$\geq 24^\circ$	



Expert know-how for competition pools

Special know-how is required at the planning of sports pools satisfying competition standards. The in-house planning department of AGROB BUCHTAL bundles the experience from the construction of hundreds of sports pools world-wide and offers its knowledge as competent adviser at the realization of such building projects.

However, it's not just about the precise knowledge of and compliance with the rules, which are the prerequisite for recognition by the international swimming association FINA. The special products which also characterize the quality of a sports pool are a frequently discussed topic. This concerns the marking of the lanes on the pool floor, but also the end walls, which support the swimmers' turns and push-offs thanks to slip-resistant surfaces. The experts from AGROB BUCHTAL will be pleased to explain the advantages of appropriate product solutions. They support their dialogue partners with a wide spectrum of water sports experience: with swimming, water polo and diving, but also with "exotics" such as underwater hockey.

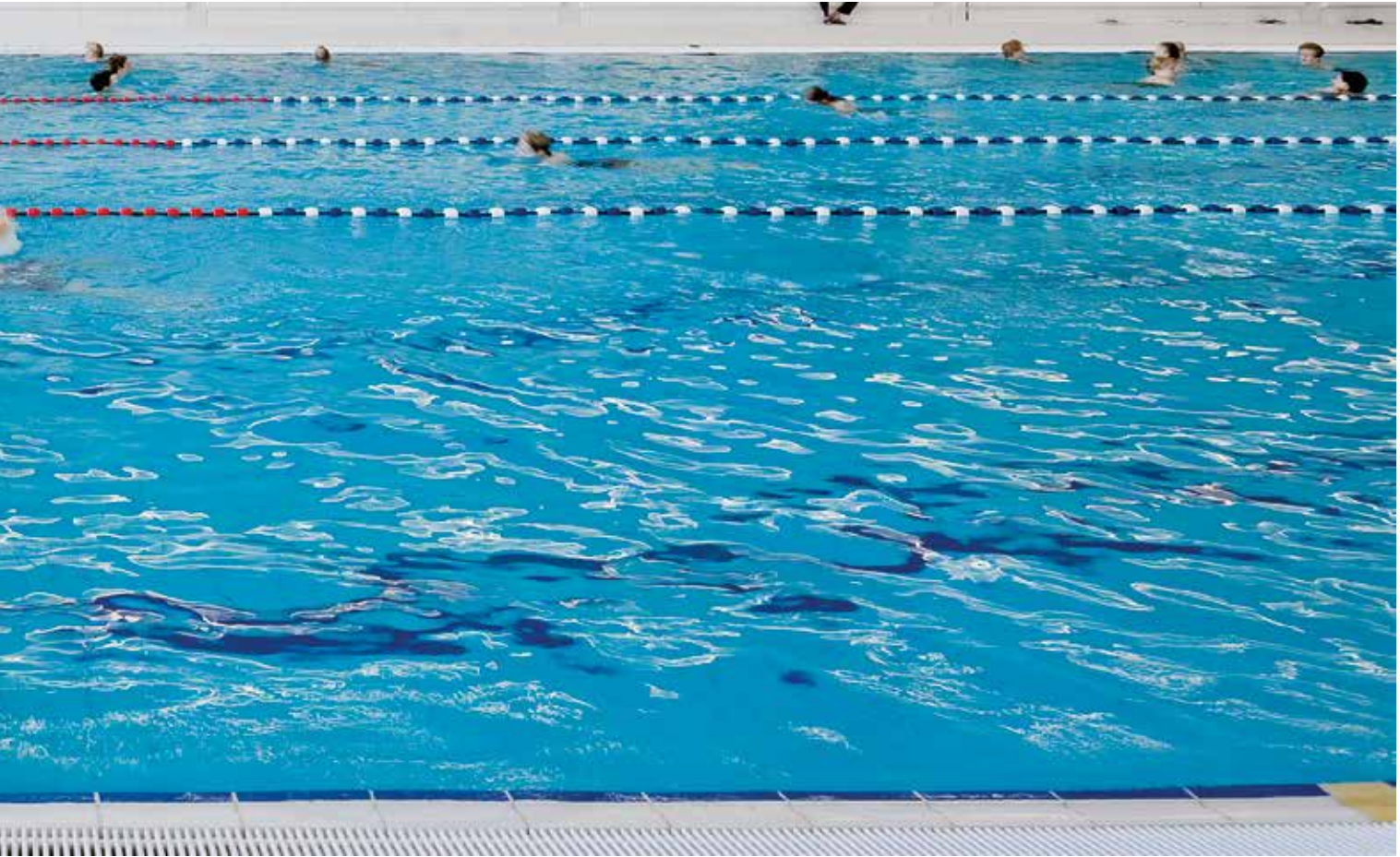

Sportcomplex Koning Willem-Alexander / Hoofddorp, Netherlands / Architect: Slangen+Koenis Architecten / Photo: Marcel van der Burg



Gold Coast Aquatic Centre / Gold Coast, Australia
Architect: Cox Rayner Architects / Photo: Christopher Frederick Jones



Hawthorn Aquatic and Leisure Centre / Melbourne, Victoria, Australia
Architect: Dwp/Suters / Photo: Emma Cross, West Brunswick



Europa Sportpark / Berlin, Germany / Architect: APP Dominique Perrault, Berlin / Photo: Hans-Georg Trimborn, Berlin



Krandelbad, Wildeshausen, Germany
 Architect: janßen bär partnerschaft mbB, Bad Zwischenahn, Germany
 Photo: Jochen Stüber



Aquarama Kristiansand, Norway / Architect: Asplan Viak AS
 Photo: Anders Martinsen

Safety for people with handicap

Exercise in water is relaxing and healthy. This also applies to people with disabilities. Therefore, disabled-friendly planning and equipment also play an important part in swimming pool construction. AGROB BUCHTAL supports architects in this task with technically sophisticated and visually appealing solutions which enable wheelchair users and people with visual impairment to enjoy an untroubled visit to the pool.

A high pool edge is helpful

The "Koordinierungskreis Bäder" (coordinating organization for pool construction), to which "Deutsche Gesellschaft für das Badewesen", the German Swimming Association and the German Olympic Sports Association belong, has also addressed this issue and formulated corresponding requirements in its "Directives for Swimming Pool Construction". For example, a raised pool edge is recommended for wheelchair users, as offered by the corresponding pool edge systems from AGROB BUCHTAL. This has the advantage that bathers can move from the wheelchair to the pool edge independently and slide into the water from there. People with disabilities who are unable to move from the wheelchair into the water on their own are assisted by so-called swimming pool lifters, which are mounted at the pool edge. To avoid endangering other visitors, it should be possible to "park" the wheelchair outside the pool surround.

Orientation for people with visual impairment

Besides people with limited mobility, blind and visually impaired people also need specific support when visiting the swimming pool. It goes without saying that no equipment should be placed in corridors or on walkways. In addition, special products from AGROB BUCHTAL, such as e.g. tactile and visually easily perceptible grooved tiles arranged as guide strips for blind people, can help these bathers to find their way. If the water level is at pool surround height, a small bulge outside the overflow channel makes it easier to feel the pool edge with the "white stick". As an alternative or additional feature, the "Koordinierungskreis Bäder" recommends gently inclined stairs which people with disabilities can use to slowly enter the pool.

Barrier-free, slip-resistant and beautiful

Finally, barrier-free showers are essential for a disabled-friendly swimming pool. Ceramic shower tub systems and appropriate drainage channels are an integral part of the AGROB BUCHTAL range. They allow a consistent design and also correspond to the adjoining floor covering with regard to slip resistance.



Horner Bad, Bremen, Germany / Architect: janßen bär partnerschaft mbB, Bad Zwischenahn
Series: Emotion, Plural unglazed / Photo: Jochen Stüber



Ceramic Shower Tub System
Studio photo / Series: Quantum



Kombibad Gropiusstadt, Berlin, Germany
Architect: Veauthier Meyer Architekten / Photo: Jochen Stüber



Indoor swimming pool Wolbeck, Münster, Germany
Architect: Otten beratende Ingenieure
Photo: Alfons Seggewiß



Cleaning tiles properly

Easy cleaning and lasting beauty are among the key advantages of ceramic floor and wall coverings. Even slip-resistant tiles with their rougher surface and tiles with Hytect technology retain their look and functionality for a very long time if they are cleaned properly.

Slip-resistant tiles of the classes A, B and C can be cleaned without hesitation by means of cleaning machines with rotating, soft nylon brushes or microfibre fleece as well as with high-pressure or steam cleaners.

The use of pads or brushes with abrasive grain addition is not permitted because they can significantly reduce the slip resistance!

As a general rule, only cleaning agents should be used which are included in the List of Tested Cleaning Agents for ceramic coverings in swimming pools published by "Deutsche Gesellschaft für das Badewesen". The instructions for use and hazard warnings of the respective manufacturer must always be observed.

Cleaning agents containing hydrofluoric acid or fluorides are absolutely unsuitable because they attack the ceramics even if diluted with plenty of water.



At the **first cleaning after completion of the construction works** and removal of the coarse dirt, cement films usually have to be removed. Only acid cleaners (cement film removers) are suitable for this, but they attack cement-based joints. Such joints must therefore be pre-wetted and thoroughly rinsed after cleaning.

At the **basic cleaning, a particularly careful interim cleaning**, stains often also have to be removed. Here are the most common stains and the respective suitable agents:

- Calcareous deposits, urine stone, rust stains, metal abrasion residues: acid cleaners
- Tar, bitumen, paint drops, residues from expansion joints: naphtha, acetone or caustic pastes
- Epoxy resins: caustic pastes or special cleaning agents
- Oil, grease, wax: highly alkaline cleaners; if required, solvents in addition
- Rubber abrasion residues, pencil lines: mechanical removal by rubbing or brushing, possibly with scouring powder

In most cases, increased exposure times and mechanical support by brushing can improve the cleaning result.

Alkaline cleaning agents are recommended for the **regular maintenance cleaning**, as they are best at dissolving everyday dirt. Depending on the water hardness, it is necessary to alternate cleaning with acid cleaning agents. In general, the following procedure has proved itself:

- Spread the cleaner in the appropriate dilution (depending on the degree of soiling) on the covering
- Let the cleaner act upon the dirt for about 15 minutes, support the chemical dissolving of the dirt mechanically with nylon brushes (without abrasive grain addition)
- Then collect or rinse away the dissolved dirt solution with sufficient water
- Thoroughly rinse the covering

Cleaners containing care products are not necessary. On the contrary: in the long term, sticky layers of grease, wax and plastic can build up, which have a negative effect on the look, hygiene and slip resistance, and also make cleaning more difficult. Disinfectants must be thoroughly removed after the exposure time. Otherwise, together with moisture, they can form a lubricating layer which impairs slip resistance.

The Hytect technology, which has an antibacterial effect and eliminates unpleasant odours in addition, significantly reduces the cleaning effort. It is not affected by either strongly acid or strongly alkaline cleaning agents. However, cleaners containing care products are not recommended also in this context, as the care product film not only reduces the slip resistance, but also impairs the functionality of the coating. If an already existing care product film is thoroughly removed, Hytect will also regain its full effectiveness.





Contents

• Article numbers	262 - 271
• Index according to models	272
• Model numbers	273
• Classification accord. to NCS/RAL / Lightness values	274 - 275
• Luminance contrast	276 - 277
Technical information	278 - 297
World-wide distribution network	298 - 299
Comments	302 - 303

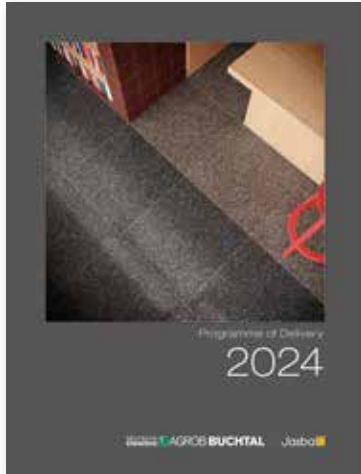

As of now, you will find all article numbers for architectural ceramics in our 2024 programme of delivery.

Article No.	Page(s)	Article No.	Page(s)	Article No.	Page(s)	Article No.	Page(s)	Article No.	Page(s)	Article No.	Page(s)
052036-53510	83	115-1005H	176	116-1013H	176	120-1021H	178	130-1028H	178	140-1035H	178
052036-53511	83	115-1006H	176	116-1014H	176	120-1022H	178	130-1029H	178	140-1036H	178
052036-53512	83	115-1007H	176	116-1015H	176	120-1023H	178	130-1030H	178	140-1037H	178
113-1001H	176	115-1008H	176	116-1016H	176	120-1024H	178	130-1031H	178	140-1038H	178
113-1002H	176	115-1009H	176	116-1017H	178	120-1025H	178	130-1032H	178	140-1039H	178
113-1003H	176	115-1010H	176	116-1018H	178	120-1026H	178	130-1033H	178	140-1040H	178
113-1004H	176	115-1011H	176	116-1019H	178	120-1027H	178	130-1034H	178	140-1111H	176
113-1005H	176	115-1012H	176	116-1020H	178	120-1028H	178	130-1035H	178	140-1112H	176
113-1006H	176	115-1013H	176	116-1021H	178	120-1029H	178	130-1036H	178	140-1113H	176
113-1007H	176	115-1014H	176	116-1022H	178	120-1030H	178	130-1037H	178	140-1114H	176
113-1008H	176	115-1015H	176	116-1023H	178	120-1031H	178	130-1038H	178	140-1115H	176
113-1009H	176	115-1016H	176	116-1024H	178	120-1032H	178	130-1039H	178	140-1116H	176
113-1010H	176	115-1017H	178	116-1025H	178	120-1033H	178	130-1040H	178	140-1117H	176
113-1011H	176	115-1018H	178	116-1026H	178	120-1034H	178	130-1111H	176	140-1118H	176
113-1012H	176	115-1019H	178	116-1027H	178	120-1035H	178	130-1112H	176	140-1119H	176
113-1013H	176	115-1020H	178	116-1028H	178	120-1036H	178	130-1113H	176	140-1120H	176
113-1014H	176	115-1021H	178	116-1029H	178	120-1037H	178	130-1114H	176	140-1121H	176
113-1015H	176	115-1022H	178	116-1030H	178	120-1038H	178	130-1115H	176	144-12020	151
113-1016H	176	115-1023H	178	116-1031H	178	120-1039H	178	130-1116H	176	144-12050	151
113-1017H	178	115-1024H	178	116-1032H	178	120-1040H	178	130-1117H	176	144-18120	151
113-1018H	178	115-1025H	178	116-1033H	178	120-1111H	176	130-1118H	176	144-18210	151
113-1019H	178	115-1026H	178	116-1034H	178	120-1112H	176	130-1119H	176	144-41550K	151
113-1020H	178	115-1027H	178	116-1035H	178	120-1113H	176	130-1120H	176	144-42550K	151
113-1021H	178	115-1028H	178	116-1036H	178	120-1114H	176	130-1121H	176	150i-12020H	151
113-1022H	178	115-1029H	178	116-1037H	178	120-1115H	176	140-1001H	176	150i-12050H	151
113-1023H	178	115-1030H	178	116-1038H	178	120-1116H	176	140-1002H	176	150i-18120H	151
113-1024H	178	115-1031H	178	116-1039H	178	120-1117H	176	140-1003H	176	150i-18210H	151
113-1025H	178	115-1032H	178	116-1040H	178	120-1118H	176	140-1004H	176	150i-41550HK	151
113-1026H	178	115-1033H	178	116-1111H	176	120-1119H	176	140-1005H	176	150i-42550HK	151
113-1027H	178	115-1034H	178	116-1112H	176	120-1120H	176	140-1006H	176	151i-12020H	151
113-1028H	178	115-1035H	178	116-1113H	176	120-1121H	176	140-1007H	176	151i-12050H	151
113-1029H	178	115-1036H	178	116-1114H	176	130-1001H	176	140-1008H	176	151i-18120H	151
113-1030H	178	115-1037H	178	116-1115H	176	130-1002H	176	140-1009H	176	151i-18210H	151
113-1031H	178	115-1038H	178	116-1116H	176	130-1003H	176	140-1010H	176	151i-41550HK	151
113-1032H	178	115-1039H	178	116-1117H	176	130-1004H	176	140-1011H	176	151i-42550HK	151
113-1033H	178	115-1040H	178	116-1118H	176	130-1005H	176	140-1012H	176	152i-12020H	151
113-1034H	178	115-1111H	176	116-1119H	176	130-1006H	176	140-1013H	176	152i-12050H	151
113-1035H	178	115-1112H	176	116-1120H	176	130-1007H	176	140-1014H	176	152i-18120H	151
113-1036H	178	115-1113H	176	120-1001H	176	130-1008H	176	140-1015H	176	152i-18210H	151
113-1037H	178	115-1114H	176	120-1002H	176	130-1009H	176	140-1016H	176	152i-41550HK	151
113-1038H	178	115-1115H	176	120-1003H	176	130-1010H	176	140-1017H	178	152i-42550HK	151
113-1039H	178	115-1116H	176	120-1004H	176	130-1011H	176	140-1018H	178	153i-12020H	151
113-1040H	178	115-1117H	176	120-1005H	176	130-1012H	176	140-1019H	178	153i-12050H	151
113-1111H	176	115-1118H	176	120-1006H	176	130-1013H	176	140-1020H	178	153i-18120H	151
113-1112H	176	115-1119H	176	120-1007H	176	130-1014H	176	140-1021H	178	153i-18210H	151
113-1113H	176	115-1121H	176	120-1008H	176	130-1015H	176	140-1022H	178	153i-41550HK	151
113-1114H	176	116-1001H	176	120-1009H	176	130-1016H	176	140-1023H	178	153i-42550HK	151
113-1115H	176	116-1002H	176	120-1010H	176	130-1017H	178	140-1024H	178	154i-12020H	151
113-1116H	176	116-1003H	176	120-1011H	176	130-1018H	178	140-1025H	178	154i-12050H	151
113-1117H	176	116-1004H	176	120-1012H	176	130-1019H	178	140-1026H	178	154i-18120H	151
113-1118H	176	116-1005H	176	120-1013H	176	130-1020H	178	140-1027H	178	154i-18210H	151
113-1119H	176	116-1006H	176	120-1014H	176	130-1021H	178	140-1028H	178	154i-41550HK	151
113-1120H	176	116-1007H	176	120-1015H	176	130-1022H	178	140-1029H	178	154i-42550HK	151
113-1121H	176	116-1008H	176	120-1016H	176	130-1023H	178	140-1030H	178	160-1001H	176
115-1001H	176	116-1009H	176	120-1017H	178	130-1024H	178	140-1031H	178	160-1002H	176
115-1002H	176	116-1010H	176	120-1018H	178	130-1025H	178	140-1032H	178	160-1003H	176
115-1003H	176	116-1011H	176	120-1019H	178	130-1026H	178	140-1033H	178	160-1004H	176
115-1004H	176	116-1012H	176	120-1020H	178	130-1027H	178	140-1034H	178	160-1005H	176

Article No.	Page(s)	Article No.	Page(s)	Article No.	Page(s)	Article No.	Page(s)	Article No.	Page(s)	Article No.	Page(s)
160-1006H	176	220-1036H	179	340-37182	99	360-1003H	177	40042H	246	41410H	236
160-1007H	176	220-1037H	179	340-37183	100	360-1004H	177	40044H	246	41411H	236
160-1008H	176	220-1038H	179	340-37185	100	360-1005H	177	40047H	246	41412H	236
160-1009H	176	220-1039H	179	340-37188	99	360-1006H	177	40048H	246	41413H	236
160-1010H	176	220-1040H	179	340-37189	100	360-1007H	177	40050H	245	41414H	236
160-1011H	176	220-1111H	177	340-53150	32	360-1008H	177	40051H	245	41415H	236
160-1012H	176	220-1112H	177	340-53151	32	360-1009H	177	40052H	245	41420H	236
160-1013H	176	220-1113H	177	340-53159	32	360-1010H	177	40053H	245	41421H	236
160-1014H	176	220-1114H	177	340-55720	26	360-1011H	177	40054H	245	41422H	236
160-1015H	176	220-1115H	177	340-55722	26	360-1012H	177	40055H	245	41423H	236
160-1016H	176	220-1116H	177	340-55725	26	360-1013H	177	40056H	245	41424H	236
160-1017H	178	220-1117H	177	340-55729	26	360-1014H	177	40057H	245	41425H	236
160-1018H	178	220-1118H	177	340-55730	25	360-1015H	177	40071H	246	41426H	236
160-1019H	178	220-1119H	177	340-55732	25	360-1016H	177	410-2008	202	41427H	236
160-1020H	178	220-1120H	177	340-55735	25	360-1017H	179	410-2023	202	41428H	236
160-1021H	178	220-1121H	177	340-55736	25	360-1018H	179	410-2038	202	41429H	236
160-1022H	178	240-1001H	177	340-55737	25	360-1019H	179	410-2039	202	41430H	236
160-1023H	178	240-1002H	177	340-55738	25	360-1020H	179	410-2040	202	41431H	236
160-1024H	178	240-1003H	177	340-55740	27	360-1021H	179	410-2041	202	41432H	236
160-1025H	178	240-1004H	177	340-55742	27	360-1022H	179	410-2042	202	41433H	236
160-1026H	178	240-1005H	177	340-55745	27	360-1023H	179	410-2043	202	41434H	236
160-1027H	178	240-1006H	177	340-55749	27	360-1024H	179	410-2111	202	41435H	236
160-1028H	178	240-1007H	177	340-55760	26	360-1025H	179	410-2113	202	41450H	236
160-1029H	178	240-1008H	177	340-55762	26	360-1026H	179	41200H	234	41451H	236
160-1030H	178	240-1009H	177	340-55765	26	360-1027H	179	41201H	234	41452H	236
160-1031H	178	240-1010H	177	340-55766	26	360-1028H	179	41202H	234	41453H	236
160-1032H	178	240-1011H	177	340-55770	26	360-1029H	179	41203H	234	41454H	236
160-1033H	178	240-1012H	177	340-55775	26	360-1030H	179	41204H	234	41455H	236
160-1034H	178	240-1013H	177	340-55820	31	360-1031H	179	41205H	234	41456H	236
160-1035H	178	240-1014H	177	340-55821	31	360-1032H	179	41206H	234	41457H	236
160-1036H	178	240-1015H	177	340-55822	31	360-1033H	179	41207H	234	41505	235
160-1037H	178	240-1016H	177	340-55825	31	360-1034H	179	41208H	234	41509	235
160-1038H	178	240-1017H	179	340-55826	31	360-1035H	179	41209H	234	41510	235
160-1039H	178	240-1018H	179	340-55830	31	360-1036H	179	41210H	234	41513	235
160-1040H	178	240-1019H	179	340-55831	31	360-1037H	179	41211H	234	41520H	234
160-1111H	176	240-1020H	179	340-55832	31	360-1038H	179	41212H	234	430701H	135
160-1112H	176	240-1021H	179	340-55835	31	360-1039H	179	41213H	234	430702H	135
160-1113H	176	240-1022H	179	340-55836	31	360-1040H	179	41214H	234	430703H	135
160-1114H	176	240-1023H	179	340-55840	32	360-1111H	177	41215H	234	430704H	135
160-1115H	176	240-1024H	179	340-55841	32	360-1112H	177	41216H	235	430705H	135
160-1116H	176	240-1025H	179	340-55845	32	360-1113H	177	41217H	235	430706H	135
160-1117H	176	240-1026H	179	340-59420	25	360-1114H	177	41218H	235	430707H	135
160-1118H	176	240-1027H	179	340-59422	25	360-1115H	177	41219H	235	430708H	135
160-1119H	176	240-1028H	179	340-59425	25	360-1116H	177	41220H	235	430709H	135
160-1120H	176	240-1029H	179	340-59426	25	360-1117H	177	41221H	235	430710H	135
160-1121H	176	240-1030H	179	340-59427	25	360-1118H	177	41222H	235	430711H	135
220-1001H	177	240-1031H	179	340-59428	25	360-1119H	177	41223H	235	430712H	135
220-1002H	177	240-1032H	179	340-59620	107	360-1120H	177	41300H	236	430713H	135
220-1003H	177	240-1033H	179	340-59627	107	360-1121H	177	41301H	236	430714H	135
220-1004H	177	240-1034H	179	340-59628	107	40000H	245	41302H	236	430715H	135
220-1005H	177	240-1035H	179	340-59629	107	40001H	245	41303H	236	430716H	135
220-1006H	177	240-1036H	179	340-59630	107	40002H	245	41304H	236	430717H	137
220-1007H	177	240-1037H	179	340-59637	107	40003H	245	41305H	236	430718H	137
220-1008H	177	240-1038H	179	340-59638	107	40004H	245	41306H	236	430719H	137
220-1009H	177	240-1039H	179	340-59639	107	40005H	245	41307H	236	430720H	137
220-1010H	177	240-1040H	179	340i-32020H	155	40006H	245	41308H	236	430721H	135
220-1011H	177	240-1111H	177	340i-32025H	157	40007H	245	41309H	236	430722H	135
220-1012H	177	240-1112H	177	340i-32027H	157	40008H	245	41310H	236	430723H	135
220-1013H	177	240-1113H	177	340i-32050H	155	40009H	245	41311H	236	430724H	135
220-1014H	177	240-1114H	177	340i-32055H	157	40010H	245	41312H	236	430725H	135
220-1015H	177	240-1115H	177	340i-32057H	157	40011H	245	41313H	236	430726H	135
220-1016H	177	240-1116H	177	340i-34070H	111	40012H	245	41314H	236	430727H	135
220-1017H	179	240-1117H	177	340i-34120H	111	40013H	245	41315H	236	430728H	135
220-1018H	179	240-1118H	177	340i-34125H	111	40014	245	41316H	236	430729H	136
220-1019H	179	240-1119H	177	340i-34127H	111	40020H	245	41317H	236	430730H	136
220-1020H	179	240-1120H	177	340i-34128H	111	40021H	245	41318H	236	430731H	136
220-1021H	179	240-1121H	177	340i-34146H	105	40022H	245	41319H	236	430732H	136
220-1022H	179	2452	235	340i-34147H	105	40023H	245	41320H	236	430733H	136
220-1023H	179	2455	235	340i-34148H	105	40024H	245	41321H	236	430734H	136
220-1024H	179	340-34126	111	340i-34149H	105	40025H	245	41322H	236	430735H	136
220-1025H	179	340-34306	111	340i-34156H	105	40026H	245	41323H	236	430736H	136
220-1026H	179	340-34307	111	340i-34157H	105	40027H	245	41400H-73	236	430737H	137
220-1027H	179	340-34308	111	340i-34158H	105	40028H	245	41401H-73	236	430738H	137
220-1028H	179	340-34309	111	340i-34159H	105	40029H	245	41402H-73	236	430739H	137
220-1029H	179	340-37120	99	340i-38110H	155	40030H	245	41403H-73	236	430740H	137
220-1030H	179	340-37121	99	340i-38115H	157	40031H	245	41404H-73	236	430741H	137
220-1031H	179	340-37122	99	340i-38116H	157	40032H	245	41405H-73	236	430742H	137
220-1032H	179	340-37125	100	340i-38117H	157	40033H	245	41406H	236	430743H	137
220-1033H	179	340-37126	100	340i-38118H	157	40034	245	41407H	236	430744H	137
220-1034H	179	340-37127	100	360-1001H	177	40040H	246	41408H	236	430753H	138
220-1035H	179	340-37180	99	360-1002H	177	40041H	246	41409H	236	430754H	138

Article No.	Page(s)	Article No.	Page(s)	Article No.	Page(s)	Article No.	Page(s)	Article No.	Page(s)	Article No.	Page(s)
430755H	138	430991H	137	435601H	32	435682	114	552001-55567	112	552002-18213H	149
430756H	138	431501H	135	435602H	32	435683	114	552001-55800	93	552002-18214H	149
430757H	138	431502H	135	435603H	32	435684	114	552001-55802	93	552002-34070H	111
430758H	138	431503H	135	435604H	32	552001-12020H	148	552001-55805	93	552002-34120H	111
430759H	138	431504H	135	435605H	32	552001-12023H	149	552001-55806	93	552002-34125H	111
430760H	138	431505H	135	435606H	32	552001-12050H	148	552001-55850	57	552002-34126H	111
430761H	138	431506H	135	435607H	32	552001-12053H	149	552001-55852	57	552002-34127H	111
430762H	138	431507H	135	435608H	32	552001-17112	97	552001-55855	57	552002-34128H	111
430763H	138	431508H	135	435609H	32	552001-17190	97	552001-55856	57	552002-341550HK	183
430764H	138	431509H	135	435610H	32	552001-17191	97	552001-55857/58	57	552002-34170H	111
430765H	138	431510H	135	435611H	32	552001-17193	97	552001-85160	37	552002-342550HK	184
430766H	138	431511H	135	435612H	32	552001-17194	97	552001-85161	37	552002-352010HK	183
430767H	138	431512H	135	435613H	32	552001-17196	97	552001-85163	37	552002-352050HK	184
430768H	138	431513H	136	435614H	32	552001-18120H	148	552001-85165	37	552002-37088	97
430769H	138	431514H	136	435615H	32	552001-18123H	149	552001-85166	37	552002-37120	99
430770H	138	431515H	136	435616H	32	552001-18124H	149	552001-85167/68	37, 41	552002-37121	99
430771H	138	431516H	136	435617H	32	552001-18190	97	552001-85180	39	552002-37122	99
430772H	138	431523H	137	435618H	32	552001-18191	97	552001-85181	39	552002-37125	100
430773H	138	431524H	137	435619H	32	552001-18192	97	552001-85183	39	552002-37126	100
430774H	138	431525H	137	435620H	32	552001-18193	97	552001-85185	39	552002-37127	100
430775H	138	431526H	137	435621H	32	552001-18194	97	552001-85186	39	552002-37180	99
430776H	138	431527H	137	435622H	32	552001-18196	97	552001-85187/88	39	552002-37182	99
430777H	138	431528H	137	435623H	32	552001-18210H	148	552001-85190	39	552002-37183	100
430778H	138	431529H	137	435624H	32	552001-18213H	149	552001-85191	39	552002-37185	100
430779H	139	431530H	137	435625H	32	552001-18214H	149	552001-85193	39	552002-37186	97
430780H	139	431531H	137	435626H	32	552001-34070H	111	552001-85195	39	552002-37188	99
430781H	139	431532H	137	435627H	32	552001-34120H	111	552001-85196	39	552002-37189	100
430782H	139	431533H	138	435628H	32	552001-34125H	111	552001-85197/98	39	552002-41550HK	148
430783H	139	431534H	138	435629H	32	552001-34126H	111	552001-86160	57	552002-42550HK	148
430784H	139	431535H	138	435630H	32	552001-34127H	111	552001-86161	57	552002-55100	49
430785H	139	431536H	138	435631H	32	552001-34128H	111	552001-86162	57	552002-55101	49
430786H	139	431537H	138	435632H	32	552001-341550HK	183	552001-86163	57	552002-55105	49
430787H	139	431538H	138	435633H	32	552001-34170H	111	552001-86165	57	552002-55106	49
430788H	139	431539H	138	435634H	32	552001-342550HK	184	552001-86167/68	57	552002-55107/08	49
430789H	33, 139	431540H	138	435635H	32	552001-352010HK	183	552001-87160	45	552002-55140	49
430790H	33, 139	431541H	138	435636H	32	552001-352050HK	184	552001-87161	45	552002-55141	49
430791H	33, 139	431542H	138	435637H	114	552001-37088	97	552001-87163	45	552002-55143	49
430792H	33, 139	431543H	138	435638	114	552001-37120	99	552001-87165	45	552002-55145	49
430793H	33, 139	431544H	138	435639	114	552001-37121	99	552001-87166	45	552002-55146	49
430794H	33, 139	431545H	138	435640	114	552001-37122	99	552001-87167/68	45	552002-55147/48	49
430795H	33, 139	431546H	139	435641	114	552001-37125	100	552001-95160	41	552002-55180	37
430796H	33, 139	431547H	139	435642	114	552001-37126	100	552001-95161	41	552002-55181	37
430802H	33, 139	431548H	139	435643	114	552001-37127	100	552001-95163	41	552002-55185	37
430803H	33, 139	431549H	139	435644	114	552001-37180	99	552001-95165	41	552002-55186	37
430804H	33, 139	431550H	139	435645	114	552001-37182	99	552001-95166	41	552002-55187/88	37, 41
430805H	33, 139	431551H	33, 139	435646	114	552001-37183	100	552001-95180	41	552002-55440	92
430806H	140	431552H	33, 139	435647	114	552001-37185	100	552001-95181	41	552002-55442	92
430807H	140	431553H	33, 139	435648	114	552001-37186	97	552001-95183	41	552002-55445	92
430808H	140	431554H	33, 139	435649H	114	552001-37188	99	552001-95185	41	552002-55446	92
430809H	140	431555H	33, 139	435650	114	552001-37189	100	552001-95186	41	552002-55460	93
430810H	115, 140	431556H	33, 139	435651	114	552001-41550HK	148	552001-550044	37	552002-55462	93
430811H	115	431557H	140	435652	114	552001-42550HK	148	552001-550065	49	552002-55465	93
430812H	115, 140	431558H	140	435653	114	552001-55100	49	552001-555102	49	552002-55466	93
430813H	115, 140	431559H	115, 140	435654	114	552001-55101	49	552001-555142	49	552002-55561	112
430814H	115, 140	431560H	115, 140	435655	114	552001-55105	49	552001-555182	37	552002-55562	112
430815H	115, 140	431561H	115, 140	435656	114	552001-55106	49	552001-585162	37	552002-55563	112
430816H	115, 140	431562H	115, 140	435657	114	552001-55107/08	49	552001-585182	39	552002-55565	112
430817H	115, 140	431563H	115, 140	435658	114	552001-55140	49	552001-585192	39	552002-55566	112
430818H	115, 140	431564H	115, 140	435659	114	552001-55141	49	552001-587162	45	552002-55567	112
430819H	115, 140	431565H	115, 140	435660	114	552001-55143	49	552001-595162	41	552002-55800	93
430820H	115, 140	431566H	115, 140	435661H	114	552001-55145	49	552001-595182	41	552002-55802	93
430821H	115, 140	431567H	141	435662	114	552001-55146	49	552002-12020H	148	552002-55805	93
430822H	115, 140	431568H	141	435663	114	552001-55147/48	49	552002-12023H	149	552002-55806	93
430823H	115, 140	431576H	136	435664	114	552001-55180	37	552002-12050H	148	552002-55850	57
430824H	115, 140	431576H-TF	136	435665	114	552001-55181	37	552002-12053H	149	552002-55852	57
430825H	115, 140	431577H	136	435666	114	552001-55185	37	552002-17112	97	552002-55855	57
430826H	141	431577H-TF	136	435667	114	552001-55186	37	552002-17190	97	552002-55856	57
430827H	141	431578H	136	435668	114	552001-55187/88	37, 41	552002-17191	97	552002-55857/58	57
430828H	141	431578H-TF	136	435669	114	552001-55440	92	552002-17193	97	552002-85160	37
430829H	141	431579H	136	435670	114	552001-55442	92	552002-17194	97	552002-85161	37
430830H	141	431579H-TF	136	435671	114	552001-55445	92	552002-17196	97	552002-85163	37
430831H	141	431580H	136	435672	114	552001-55446	92	552002-18120H	148	552002-85165	37
430832H	141	431580H-TF	136	435673H	114	552001-55460	93	552002-18123H	149	552002-85166	37
430833H	141	431581H	136	435674	114	552001-55462	93	552002-18124H	149	552002-85167/68	37, 41
430984H	137	431581H-TF	136	435675	114	552001-55465	93	552002-18190	97	552002-85180	39
430985H	137	431582H	136	435676	114	552001-55466	93	552002-18191	97	552002-85181	39
430986H	137	431583H	136	435677	114	552001-55561	112	552002-18192	97	552002-85183	39
430987H	137	431584H	136	435678	114	552001-55562	112	552002-18193	97	552002-85185	39
430988H	137	431585H	136	435679	114	552001-55563	112	552002-18194	97	552002-85186	39
430989H	137	431586H	136	435680	114	552001-55565	112	552002-18196	97	552002-85187/88	39
430990H	137	431587H	136	435681	114	552001-55566	112	552002-18210H	148	552002-85190	39

Article No.	Page(s)	Article No.	Page(s)	Article No.	Page(s)	Article No.	Page(s)	Article No.	Page(s)	Article No.	Page(s)
552002-85191	39	552007-18210H	148	552015-341550HK	183	552023-342550HK	186	552031-352010HK	185	552039-352050HK	186
552002-85193	39	552007-341550HK	183	552015-342550HK	184	552023-352010HK	186	552031-352050HK	186	552039-41550HK	151
552002-85195	39	552007-342550HK	184	552015-352010HK	183	552023-352050HK	185	552031-41550HK	150	552039-42550HK	151
552002-85196	39	552007-352010HK	183	552015-352050HK	184	552023-41550HK	150	552031-42550HK	150	552040-12020H	151
552002-85197/98	39	552007-352050HK	184	552015-41550HK	150	552023-42550HK	150	552032-12020H	150	552040-12050H	151
552002-86160	57	552007-41550HK	148	552015-42550HK	148	552024-12020H	150	552032-12050H	150	552040-18120H	151
552002-86161	57	552007-42550HK	148	552016-12020H	150	552024-12050H	150	552032-18120H	150	552040-18210H	151
552002-86162	57	552008-12020H	148	552016-12050H	150	552024-18120H	150	552032-18210H	150	552040-341550HK	185
552002-86163	57	552008-12050H	148	552016-18120H	150	552024-18210H	150	552032-341550HK	185	552040-342550HK	186
552002-86165	57	552008-18120H	148	552016-18210H	150	552024-341550HK	185	552032-342550HK	186	552040-352010HK	185
552002-86167/68	57	552008-18210H	148	552016-341550HK	183	552024-342550HK	186	552032-352010HK	185	552040-352050HK	186
552002-87160	45	552008-341550HK	183	552016-342550HK	184	552024-352010HK	185	552032-352050HK	186	552040-41550HK	151
552002-87161	45	552008-342550HK	184	552016-352010HK	183	552024-352050HK	186	552032-41550HK	150	552040-42550HK	151
552002-87163	45	552008-352010HK	183	552016-352050HK	184	552024-41550HK	150	552032-42550HK	150	552112-12020H	148
552002-87165	45	552008-352050HK	184	552016-41550HK	150	552024-42550HK	150	552033-12020H	151	552112-12050H	148
552002-87166	45	552008-41550HK	148	552016-42550HK	150	552025-12020H	150	552033-12050H	151	552112-18120H	148
552002-87167/68	45	552008-42550HK	148	552017-12020H	150	552025-12050H	150	552033-18120H	151	552112-18210H	148
552002-95160	41	552009-12020H	148	552017-12050H	150	552025-18120H	150	552033-18210H	151	552112-341550HK	183
552002-95161	41	552009-12050H	148	552017-18120H	150	552025-18210H	150	552033-341550HK	185	552112-342550HK	184
552002-95163	41	552009-18120H	148	552017-18210H	150	552025-341550HK	185	552033-342550HK	186	552112-352010HK	183
552002-95165	41	552009-18210H	148	552017-341550HK	185	552025-342550HK	186	552033-352010HK	185	552112-352050HK	184
552002-95166	41	552009-341550HK	183	552017-342550HK	186	552025-352010HK	185	552033-352050HK	186	552112-41550HK	148
552002-95180	41	552009-342550HK	184	552017-352010HK	185	552025-352050HK	186	552033-41550HK	151	552112-42550HK	148
552002-95181	41	552009-352010HK	183	552017-352050HK	186	552025-41550HK	150	552033-42550HK	151	552113-12020H	148
552002-95183	41	552009-352050HK	184	552017-41550HK	150	552025-42550HK	150	552034-12020H	151	552113-12050H	148
552002-95185	41	552009-41550HK	148	552017-42550HK	150	552026-12020H	150	552034-12050H	151	552113-18120H	148
552002-95186	41	552009-42550HK	148	552018-12020H	150	552026-12050H	150	552034-18120H	151	552113-18210H	148
552002-550044	37	552010-12020H	148	552018-12050H	150	552026-18120H	150	552034-18210H	151	552113-341550HK	183
552002-550065	49	552010-12050H	148	552018-18120H	150	552026-18210H	150	552034-341550HK	185	552113-342550HK	184
552002-555102	49	552010-18120H	148	552018-18210H	150	552026-341550HK	185	552034-342550HK	186	552113-352010HK	183
552002-555142	49	552010-18210H	148	552018-341550HK	185	552026-342550HK	186	552034-352010HK	185	552113-352050HK	184
552002-555182	37	552010-341550HK	183	552018-342550HK	186	552026-352010HK	185	552034-352050HK	186	552113-41550HK	148
552002-585162	37	552010-342550HK	184	552018-352010HK	185	552026-352050HK	186	552034-41550HK	151	552113-42550HK	148
552002-585182	39	552010-352010HK	183	552018-352050HK	186	552026-41550HK	150	552034-42550HK	151	552114-12020H	148
552002-585192	39	552010-352050HK	184	552018-41550HK	150	552026-42550HK	150	552035-12020H	151	552114-12050H	148
552002-587162	45	552010-41550HK	148	552018-42550HK	150	552027-12020H	150	552035-12050H	151	552114-18120H	148
552002-595162	41	552010-42550HK	148	552019-12020H	150	552027-12050H	150	552035-18120H	151	552114-18210H	148
552002-595182	41	552011-12020H	148	552019-12050H	150	552027-18120H	150	552035-18210H	151	552114-341550HK	183
552003-12020H	148	552011-12050H	148	552019-18120H	150	552027-18210H	150	552035-341550HK	185	552114-342550HK	184
552003-12050H	148	552011-18120H	148	552019-18210H	150	552027-341550HK	185	552035-342550HK	186	552114-352010HK	183
552003-18120H	148	552011-18210H	148	552019-341550HK	185	552027-342550HK	186	552035-352010HK	185	552114-352050HK	184
552003-18210H	148	552011-341550HK	183	552019-342550HK	186	552027-352010HK	185	552035-352050HK	186	552114-41550HK	148
552003-341550HK	183	552011-342550HK	184	552019-352010HK	185	552027-352050HK	186	552035-41550HK	151	552114-42550HK	148
552003-342550HK	184	552011-352010HK	183	552019-352050HK	186	552027-41550HK	150	552035-42550HK	151	552115-12020H	148
552003-352010HK	183	552011-352050HK	184	552019-41550HK	150	552027-42550HK	150	552036-12020H	151	552115-12050H	148
552003-352050HK	184	552011-41550HK	148	552019-42550HK	150	552028-12020H	150	552036-12050H	151	552115-18120H	148
552003-41550HK	148	552011-42550HK	148	552020-12020H	150	552028-12050H	150	552036-18120H	151	552115-18210H	148
552003-42550HK	148	552012-12020H	148	552020-12050H	150	552028-18120H	150	552036-18210H	151	552115-341550HK	183
552004-12020H	148	552012-12050H	148	552020-18120H	150	552028-18210H	150	552036-341550HK	185	552115-342550HK	184
552004-12050H	148	552012-18120H	148	552020-18210H	150	552028-341550HK	185	552036-342550HK	186	552115-352010HK	183
552004-18120H	148	552012-18210H	148	552020-341550HK	185	552028-342550HK	186	552036-352010HK	185	552115-352050HK	184
552004-18210H	148	552012-341550HK	183	552020-342550HK	186	552028-352010HK	185	552036-352050HK	186	552115-41550HK	148
552004-341550HK	183	552012-342550HK	184	552020-352010HK	185	552028-352050HK	186	552036-41550HK	151	552115-42550HK	148
552004-342550HK	184	552012-352010HK	183	552020-352050HK	186	552028-41550HK	150	552036-42550HK	151	552116-12020H	148
552004-352010HK	183	552012-352050HK	184	552020-41550HK	150	552028-42550HK	150	552037-12020H	151	552116-12050H	148
552004-352050HK	184	552012-41550HK	148	552020-42550HK	150	552029-12020H	150	552037-12050H	151	552116-18120H	148
552004-41550HK	148	552012-42550HK	148	552021-12020H	150	552029-12050H	150	552037-18120H	151	552116-18210H	148
552004-42550HK	148	552013-12020H	150	552021-12050H	150	552029-18120H	150	552037-18210H	151	552116-341550HK	183
552005-12020H	148	552013-12050H	150	552021-18120H	150	552029-18210H	150	552037-341550HK	185	552116-342550HK	184
552005-12050H	148	552013-18120H	150	552021-18210H	150	552029-341550HK	185	552037-342550HK	186	552116-352010HK	183
552005-18120H	148	552013-18210H	150	552021-341550HK	185	552029-342550HK	186	552037-352010HK	185	552116-352050HK	184
552005-18210H	148	552013-341550HK	183	552021-342550HK	186	552029-352010HK	185	552037-352050HK	186	552116-41550HK	148
552005-341550HK	183	552013-342550HK	184	552021-352010HK	185	552029-352050HK	186	552037-41550HK	151	552116-42550HK	148
552005-342550HK	184	552013-352010HK	183	552021-352050HK	186	552029-41550HK	150	552037-42550HK	151	552117-12020H	148
552005-352010HK	183	552013-352050HK	184	552021-41550HK	150	552029-42550HK	150	552038-12020H	151	552117-12050H	148
552005-352050HK	184	552013-41550HK	150	552021-42550HK	150	552030-12020H	150	552038-12050H	151	552117-18120H	148
552005-41550HK	148	552013-42550HK	150	552022-12020H	150	552030-12050H	150	552038-18120H	151	552117-18210H	148
552005-42550HK	148	552014-12020H	150	552022-12050H	150	552030-18120H	150	552038-18210H	151	552117-341550HK	183
552006-12020H	148	552014-12050H	150	552022-18120H	150	552030-18210H	150	552038-341550HK	185	552117-342550HK	184
552006-12050H	148	552014-18120H	150	552022-18210H	150	552030-341550HK	185	552038-342550HK	186	552117-352010HK	183
552006-18120H	148	552014-18210H	150	552022-341550HK	185	552030-342550HK	186	552038-352010HK	185	552117-352050HK	184
552006-18210H	148	552014-341550HK	183	552022-342550HK	186	552030-352010HK	185	552038-352050HK	186	552117-41550HK	148
552006-341550HK	183	552014-342550HK	184	552022-352010HK	185	552030-352050HK	186	552038-41550HK	151	552117-42550HK	148
552006-342550HK	184	552014-352010HK	183	552022-352050HK	186	552030-41550HK	150	552038-42550HK	151	552118-12020H	148
552006-352010HK	183	552014-352050HK	184	552022-41550HK	150	552030-42550HK	150	552039-12020H	151	552118-12050H	148
55200											

Article No.	Page(s)	Article No.	Page(s)	Article No.	Page(s)	Article No.	Page(s)	Article No.	Page(s)	Article No.	Page(s)
552118-41550HK	148	553001-55822	31	553002-55737	25	553027-32020H	155	554002-32055H	160	554111-32027H	160
552118-42550HK	148	553001-55825	31	553002-55738	25	553027-32050H	155	554002-32057H	160	554111-32050H	159
552119-12020H	148	553001-55826	31	553002-55740	27	553027-38110H	155	554002-37120	99	554111-32055H	160
552119-12050H	148	553001-55830	31	553002-55742	27	553031-32020H	155	554002-37121	99	554111-32057H	160
552119-18120H	148	553001-55831	31	553002-55745	27	553031-32050H	155	554002-37122	99	554111-37120	99
552119-18210H	148	553001-55832	31	553002-55749	27	553031-38110H	155	554002-37125	100	554111-37121	99
552119-341550HK	183	553001-55835	31	553002-55760	26	553033-32020H	155	554002-37126	100	554111-37122	99
552119-342550HK	184	553001-55836	31	553002-55762	26	553033-32050H	155	554002-37127	100	554111-37125	100
552119-352010HK	183	553001-55840	32	553002-55765	26	553033-38110H	155	554002-37180	99	554111-37126	100
552119-352050HK	184	553001-55841	32	553002-55766	26	553034-32020H	155	554002-37182	99	554111-37127	100
552119-41550HK	148	553001-55845	32	553002-55770	26	553034-32050H	155	554002-37183	100	554111-37180	99
552119-42550HK	148	553001-59420	25	553002-55775	26	553034-38110H	155	554002-37185	100	554111-37182	99
553001-32020H	155	553001-59422	25	553002-55820	31	553035-32020H	155	554002-37188	99	554111-37183	100
553001-32025H	157	553001-59425	25	553002-55821	31	553035-32050H	155	554002-37189	100	554111-37185	100
553001-32027H	157	553001-59426	25	553002-55822	31	553035-38110H	155	554002-38110H	159	554111-37188	99
553001-32050H	155	553001-59427	25	553002-55825	31	553036-32020H	155	554002-38115H	160	554111-37189	100
553001-32055H	157	553001-59428	25	553002-55826	31	553036-32050H	155	554002-38116H	160	554111-38110H	159
553001-32057H	157	553001-59620	107	553002-55830	31	553036-38110H	155	554002-38117H	160	554111-38115H	160
553001-34070H	111	553001-59627	107	553002-55831	31	553037-32020H	156	554002-38118H	160	554111-38116H	160
553001-34120H	111	553001-59628	107	553002-55832	31	553037-32050H	156	554003-32020H	159	554111-38117H	160
553001-34125H	111	553001-59629	107	553002-55835	31	553037-38110H	156	554003-32050H	159	554111-38118H	160
553001-34126H	111	553001-59630	107	553002-55836	31	553038-32020H	156	554003-38110H	159	554113-32020H	159
553001-34127H	111	553001-59637	107	553002-55840	32	553038-32050H	156	554004-32020H	159	554113-32050H	159
553001-34128H	111	553001-59638	107	553002-55841	32	553038-38110H	156	554004-32050H	159	554113-38110H	159
553001-34146H	105	553001-59639	107	553002-55845	32	553039-32020H	156	554004-38110H	159	554117-32020H	159
553001-34147H	105	553002-32020H	155	553002-59420	25	553039-32050H	156	554006-32020H	159	554117-32050H	159
553001-34148H	105	553002-32025H	157	553002-59422	25	553039-38110H	156	554006-32050H	159	554117-38110H	159
553001-34149H	105	553002-32027H	157	553002-59425	25	553040-32020H	156	554006-38110H	159	554118-32020H	159
553001-34156H	105	553002-32050H	155	553002-59426	25	553040-32050H	156	554007-32020H	159	554118-32050H	159
553001-34157H	105	553002-32055H	157	553002-59427	25	553040-38110H	156	554007-32050H	159	554118-38110H	159
553001-34158H	105	553002-32057H	157	553002-59428	25	553112-32020H	156	554007-38110H	159	554119-32020H	159
553001-34159H	105	553002-34070H	111	553002-59620	107	553112-32050H	156	554008-32020H	159	554119-32050H	159
553001-34306	111	553002-34120H	111	553002-59627	107	553112-38110H	156	554008-32050H	159	554119-38110H	159
553001-34307	111	553002-34125H	111	553002-59628	107	553113-32020H	156	554008-38110H	159	555023-27180H	168
553001-34308	111	553002-34126H	111	553002-59629	107	553113-32050H	156	554010-32020H	159	555023-27181H	168
553001-34309	111	553002-34127H	111	553002-59630	107	553113-38110H	156	554010-32050H	159	555023-27182H	168
553001-37120	99	553002-34128H	111	553002-59637	107	553114-32020H	156	554010-38110H	159	555023-32020H	166
553001-37121	99	553002-34146H	105	553002-59638	107	553114-32050H	156	554011-32020H	159	555023-32050H	166
553001-37122	99	553002-34147H	105	553002-59639	107	553114-38110H	156	554011-32050H	159	555023-32080H	167
553001-37125	100	553002-34148H	105	553003-32020H	155	553115-32020H	156	554011-38110H	159	555023-32100H	167
553001-37126	100	553002-34149H	105	553003-32050H	155	553115-32050H	156	554014-32020H	159	555023-34090H	167
553001-37127	100	553002-34156H	105	553003-38110H	155	553115-38110H	156	554014-32050H	159	555023-38110H	166
553001-37180	99	553002-34157H	105	553004-32020H	155	553116-32020H	156	554014-38110H	159	555023-42550HK	166
553001-37182	99	553002-34158H	105	553004-32050H	155	553116-32050H	156	554015-32020H	159	555023-42580HK	167
553001-37183	100	553002-34159H	105	553004-38110H	155	553116-38110H	156	554015-32050H	159	555035-27180H	168
553001-37185	100	553002-34306	111	553006-32020H	155	553117-32020H	156	554015-38110H	159	555035-27181H	168
553001-37188	99	553002-34307	111	553006-32050H	155	553117-32050H	156	554016-32020H	159	555035-27182H	168
553001-37189	100	553002-34308	111	553006-38110H	155	553117-38110H	156	554016-32050H	159	555035-32020H	166
553001-38110H	155	553002-34309	111	553007-32020H	155	553118-32020H	156	554016-38110H	159	555035-32050H	166
553001-38115H	157	553002-37120	99	553007-32050H	155	553118-32050H	156	554019-32020H	159	555035-32080H	167
553001-38116H	157	553002-37121	99	553007-38110H	155	553118-38110H	156	554019-32050H	159	555035-38110H	166
553001-38117H	157	553002-37122	99	553008-32020H	155	553119-32020H	156	554019-38110H	159	555035-34090H	167
553001-38118H	157	553002-37125	100	553008-32050H	155	553119-32050H	156	554023-32020H	159	555035-38110H	166
553001-53150	32	553002-37126	100	553008-38110H	155	553119-38110H	156	554023-32050H	159	555035-42550HK	166
553001-53151	32	553002-37127	100	553010-32020H	155	554001-32020H	159	554023-38110H	159	555035-42580HK	167
553001-53159	32	553002-37180	99	553010-32050H	155	554001-32025H	160	554026-32020H	159	555036-27180H	168
553001-55520	93	553002-37182	99	553010-38110H	155	554001-32027H	160	554026-32050H	159	555036-27181H	168
553001-55522	93	553002-37183	100	553011-32020H	155	554001-32050H	159	554026-38110H	159	555036-27182H	168
553001-55526	93	553002-37185	100	553011-32050H	155	554001-32055H	160	554027-32020H	159	555036-32020H	166
553001-55720	26	553002-37188	99	553011-38110H	155	554001-32057H	160	554027-32050H	159	555036-32050H	166
553001-55722	26	553002-37189	100	553014-32020H	155	554001-37120	99	554027-38110H	159	555036-32080H	167
553001-55725	26	553002-38110H	155	553014-32050H	155	554001-37121	99	554031-32020H	159	555036-32100H	167
553001-55729	26	553002-38115H	157	553014-38110H	155	554001-37122	99	554031-32050H	159	555036-34090H	167
553001-55730	25	553002-38116H	157	553015-32020H	155	554001-37125	100	554031-38110H	159	555036-38110H	166
553001-55732	25	553002-38117H	157	553015-32050H	155	554001-37126	100	554035-32020H	159	555036-42550HK	166
553001-55735	25	553002-38118H	157	553015-38110H	155	554001-37127	100	554035-32050H	159	555036-42580HK	167
553001-55736	25	553002-53150	32	553016-32020H	155	554001-37180	99	554035-38110H	159	555038-27180H	168
553001-55737	25	553002-53151	32	553016-32050H	155	554001-37182	99	554036-32020H	159	555038-27181H	168
553001-55738	25	553002-53159	32	553016-38110H	155	554001-37183	100	554036-32050H	159	555038-27182H	168
553001-55740	27	553002-53320H	114	553018-32020H	155	554001-37185	100	554036-38110H	159	555038-32020H	166
553001-55742	27	553002-53321H	114	553018-32050H	155	554001-37188	99	554038-32020H	159	555038-32050H	166
553001-55745	27	553002-53322H	114	553018-38110H	155	554001-37189	100	554038-32050H	159	555038-32080H	167
553001-55749	27	553002-53323H	114	553019-32020H	155	554001-38110H	159	554038-38110H	159	555038-32100H	167
553001-55760	26	553002-55720	26	553019-32050H	155	554001-38115H	160	554039-32020H	159	555038-34090H	167
553001-55762	26	553002-55722	26	553019-38110H	155	554001-38116H	160	554039-32050H	159	555038-38110H	166
553001-55765	26	553002-55725	26	553023-32020H	155	554001-38117H	160	554039-38110H	159	555038-42550HK	166
553001-55766	26	553002-55729	26	553023-32050H	155	554001-38118H	160	554040-32020H	159	555038-42580HK	167
553001-55770	26	553002-55730	25	553023-38110							

Article No.	Page(s)	Article No.	Page(s)	Article No.	Page(s)	Article No.	Page(s)	Article No.	Page(s)	Article No.	Page(s)
555039-32050H	166	5716-37189	100	5716-S50044	37	700-55106	49	700-555102	49	701-2038H	185
555039-32080H	167	5716-41550HK	148	5716-S50065	49	700-55107/08	49	700-555142	49	701-2039H	185
555039-32100H	167	5716-55100	49	5716-S55100	49	700-55140	49	700-555182	37	701-2040H	185
555039-34090H	167	5716-55101	49	5716-S55142	49	700-55141	49	700-585162	37	701-2111H	183
555039-38110H	166	5716-55105	49	5716-S55182	37	700-55143	49	700-585182	39	701-2112H	183
555039-42550HK	166	5716-55106	49	5716-S85162	37	700-55145	49	700-585192	39	701-2113H	183
555039-42580HK	167	5716-55107/08	49	5716-S85182	39	700-55146	49	700-587162	45	701-2114H	183
555040-27180H	168	5716-55140	49	5716-S85192	39	700-55147/48	49	700-595162	41	701-2115H	183
555040-27181H	168	5716-55141	49	5716-S87162	45	700-55180	37	700-595182	41	701-2116H	183
555040-27182H	168	5716-55143	49	5716-S95162	41	700-55181	37	700i-12020H	148	701-2117H	183
555040-32020H	166	5716-55145	49	5716-S95182	41	700-55185	37	700i-12023H	149	701-2118H	183
555040-32050H	166	5716-55146	49	5716i-12020H	148	700-55186	37	700i-12050H	148	701-2119H	183
555040-32080H	167	5716-55147/48	49	5716i-12023H	149	700-55187/88	37, 41	700i-12053H	149	701-2120H	183
555040-32100H	167	5716-55180	37	5716i-12050H	148	700-55440	92	700i-18120H	148	701-34020	98
555040-34090H	167	5716-55181	37	5716i-12053H	149	700-55442	92	700i-18123H	149	701-37011	113
555040-38110H	166	5716-55185	37	5716i-18120H	148	700-55445	92	700i-18124H	149	701-37015	113
555040-42550HK	166	5716-55186	37	5716i-18123H	149	700-55446	92	700i-18210H	148	701-37017	113
555040-42580HK	167	5716-55187/88	37, 41	5716i-18124H	149	700-55460	93	700i-18213H	149	701-37018	113
555113-27180H	168	5716-55440	92	5716i-18210H	148	700-55462	93	700i-18214H	149	701-37021	98
555113-27181H	168	5716-55442	92	5716i-18213H	149	700-55465	93	700i-34070H	111	701-37023	98
555113-27182H	168	5716-55445	92	5716i-18214H	149	700-55466	93	700i-34120H	111	701-37024	98
555113-32020H	166	5716-55446	92	5716i-34070H	111	700-55561	112	700i-34125H	111	701-37031	113
555113-32050H	166	5716-55460	93	5716i-34120H	111	700-55562	112	700i-34126H	111	701-37035	113
555113-32080H	167	5716-55462	93	5716i-34125H	111	700-55563	112	700i-34127H	111	701-37080	98
555113-32100H	167	5716-55465	93	5716i-34127H	111	700-55565	112	700i-34128H	111	701-37081	98
555113-34090H	167	5716-55466	93	5716i-34128H	111	700-55566	112	700i-341550HK	183	701-37082	98
555113-38110H	166	5716-55561	112	5716i-34170H	111	700-55567	112	700i-34170H	111	701-37088	97
555113-42550HK	166	5716-55562	112	5716i-42550HK	148	700-55800	93	700i-342550HK	184	701-37090	98
555113-42580HK	167	5716-55563	112	610-2008	202	700-55802	93	700i-352010HK	183	701-37091	98
555117-27180H	168	5716-55565	112	610-2016	202	700-55805	93	700i-352050HK	184	701-37092	98
555117-27181H	168	5716-55566	112	610-2023	202	700-55806	93	700i-41550HK	148	701-37120	99
555117-27182H	168	5716-55567	112	610-2033	202	700-55850	57	700i-42550HK	148	701-37121	99
555117-32020H	166	5716-55800	93	610-2038	202	700-55852	57	701-17112	97	701-37122	99
555117-32050H	166	5716-55802	93	610-2039	202	700-55855	57	701-17190	97	701-37125	100
555117-32080H	167	5716-55805	93	610-2040	202	700-55856	57	701-17191	97	701-37126	100
555117-32100H	167	5716-55806	93	610-2041	202	700-55857/58	57	701-17193	97	701-37127	100
555117-34090H	167	5716-55850	57	610-2042	202	700-559680	113	701-17194	97	701-37180	99
555117-38110H	166	5716-55852	57	610-2043	202	700-59681	113	701-17196	97	701-37182	99
555117-42550HK	166	5716-55855	57	610-2111	202	700-59685	113	701-18190	97	701-37183	100
555117-42580HK	167	5716-55856	57	610-2113	202	700-85160	37	701-18191	97	701-37185	100
555118-27180H	168	5716-55857/58	57	700-17112	97	700-85161	37	701-18192	97	701-37186	97
555118-27181H	168	5716-85160	37	700-17190	97	700-85163	37	701-18193	97	701-37188	99
555118-27182H	168	5716-85161	37	700-17191	97	700-85165	37	701-18194	97	701-37189	100
555118-32020H	166	5716-85163	37	700-17193	97	700-85166	37	701-18196	97	701-44025	98
555118-32050H	166	5716-85165	37	700-17194	97	700-85167/68	37, 41	701-2001H	183	701-44026	98
555118-32080H	167	5716-85166	37	700-17196	97	700-85180	39	701-2002H	183	701-55100	49
555118-32100H	167	5716-85167/68	37, 41	700-18190	97	700-85181	39	701-2003H	183	701-55101	49
555118-34090H	167	5716-85180	39	700-18191	97	700-85183	39	701-2004H	183	701-55105	49
555118-38110H	166	5716-85181	39	700-18192	97	700-85185	39	701-2005H	183	701-55106	49
555118-42550HK	166	5716-85183	39	700-18193	97	700-85186	39	701-2006H	183	701-55107/08	49
555118-42580HK	167	5716-85185	39	700-18194	97	700-85187/88	39	701-2007H	183	701-55140	49
5716-17112	97	5716-85186	39	700-18196	97	700-85190	39	701-2008H	183	701-55141	49
5716-17190	97	5716-85187/88	39	700-37011	113	700-85191	39	701-2009H	183	701-55143	49
5716-17191	97	5716-85190	39	700-37015	113	700-85193	39	701-2010H	183	701-55145	49
5716-17193	97	5716-85191	39	700-37017	113	700-85195	39	701-2011H	183	701-55146	49
5716-17194	97	5716-85193	39	700-37018	113	700-85196	39	701-2012H	183	701-55147/48	49
5716-17196	97	5716-85195	39	700-37021	98	700-85197/98	39	701-2013H	183	701-55180	37
5716-18190	97	5716-85196	39	700-37023	98	700-86160	57	701-2014H	183	701-55181	37
5716-18191	97	5716-85197/98	39	700-37024	98	700-86161	57	701-2015H	183	701-55185	37
5716-18192	97	5716-86160	57	700-37031	113	700-86162	57	701-2016H	183	701-55186	37
5716-18193	97	5716-86161	57	700-37035	113	700-86163	57	701-2017H	185	701-55187/88	37, 41
5716-18194	97	5716-86162	57	700-37080	98	700-86165	57	701-2018H	185	701-55440	92
5716-18196	97	5716-86163	57	700-37081	98	700-86167/68	57	701-2019H	185	701-55442	92
5716-34126H	111	5716-86165	57	700-37082	98	700-87160	45	701-2020H	185	701-55445	92
5716-341550HK	183	5716-86167/68	57	700-37088	97	700-87161	45	701-2021H	185	701-55446	92
5716-342550HK	184	5716-87160	45	700-37120	99	700-87163	45	701-2022H	185	701-55460	93
5716-352010HK	183	5716-87161	45	700-37121	99	700-87165	45	701-2023H	185	701-55462	93
5716-352050HK	184	5716-87163	45	700-37122	99	700-87166	45	701-2024H	185	701-55465	93
5716-37088	97	5716-87165	45	700-37125	100	700-87167/68	45	701-2025H	185	701-55466	93
5716-37120	99	5716-87166	45	700-37126	100	700-95160	41	701-2026H	185	701-55561	112
5716-37121	99	5716-87167/68	45	700-37127	100	700-95161	41	701-2027H	185	701-55562	112
5716-37122	99	5716-95160	41	700-37180	99	700-95163	41	701-2028H	185	701-55563	112
5716-37125	100	5716-95161	41	700-37182	99	700-95165	41	701-2029H	185	701-55565	112
5716-37126	100	5716-95163	41	700-37183	100	700-95166	41	701-2030H	185	701-55566	112
5716-37127	100	5716-95165	41	700-37185	100	700-95180	41	701-2031H	185	701-55567	112
5716-37180	99	5716-95166	41	700-37186	97	700-95181	41	701-2032H	185	701-55800	93
5716-37182	99	5716-95180	41	700-37188	99	700-95183	41	701-2033H	185	701-55802	93
5716-37183	100	5716-95181	41	700-37189	100	700-95185	41	701-2034H	185	701-55805	93
5716-37185	100	5716-95183	41	700-55100	49	700-95186	41	701-2035H	185	701-55806	93
5716-37186	97	5716-95185	41	700-55101	49	700-550044	37	701-2036H	185	701-55850	57
5716-37188	99	5716-95186	41	700-55105	49	700-550065	49	701-2037H	185	701-55852	57

Article No.	Page(s)	Article No.	Page(s)	Article No.	Page(s)	Article No.	Page(s)	Article No.	Page(s)	Article No.	Page(s)
701-55855	57	702-2002H	183	703-2033H	185	710-2012H	183	715-2036H	186	730-2011H	184
701-55856	57	702-2003H	183	703-2034H	185	710-2013H	183	715-2037H	186	730-2012H	184
701-55857/58	57	702-2004H	183	703-2035H	185	710-2014H	183	715-2038H	186	730-2013H	184
701-59680	113	702-2005H	183	703-2036H	185	710-2015H	183	715-2039H	186	730-2014H	184
701-59681	113	702-2006H	183	703-2037H	185	710-2016H	183	715-2040H	186	730-2015H	184
701-59685	113	702-2007H	183	703-2038H	185	710-2017H	185	715-2111H	184	730-2016H	184
701-85160	37	702-2008H	183	703-2039H	185	710-2018H	185	715-2112H	184	730-2017H	186
701-85161	37	702-2009H	183	703-2040H	185	710-2019H	185	715-2113H	184	730-2018H	186
701-85163	37	702-2010H	183	703-2111H	183	710-2020H	185	715-2114H	184	730-2019H	186
701-85165	37	702-2011H	183	703-2112H	183	710-2021H	185	715-2115H	184	730-2020H	186
701-85166	37	702-2012H	183	703-2113H	183	710-2022H	185	715-2116H	184	730-2021H	186
701-85167/68	37, 41	702-2013H	183	703-2114H	183	710-2023H	185	715-2117H	184	730-2022H	186
701-85180	39	702-2014H	183	703-2115H	183	710-2024H	185	715-2118H	184	730-2023H	186
701-85181	39	702-2015H	183	703-2116H	183	710-2025H	185	715-2119H	184	730-2024H	186
701-85183	39	702-2016H	183	703-2117H	183	710-2026H	185	715-2120H	184	730-2025H	186
701-85185	39	702-2017H	185	703-2118H	183	710-2027H	185	717i-12020H	151	730-2026H	186
701-85186	39	702-2018H	185	703-2119H	183	710-2028H	185	717i-12050H	151	730-2027H	186
701-85187/88	39	702-2019H	185	703-2120H	183	710-2029H	185	717i-18120H	151	730-2028H	186
701-85190	39	702-2020H	185	703-2121H	183	710-2030H	185	717i-18210H	151	730-2029H	186
701-85191	39	702-2021H	185	705-2001H	183	710-2031H	185	717i-41550HK	151	730-2030H	186
701-85193	39	702-2022H	185	705-2002H	183	710-2032H	185	717i-42550HK	151	730-2031H	186
701-85195	39	702-2023H	185	705-2003H	183	710-2033H	185	720-2001H	184	730-2032H	186
701-85196	39	702-2024H	185	705-2004H	183	710-2034H	185	720-2002H	184	730-2033H	186
701-85197/98	39	702-2025H	185	705-2005H	183	710-2035H	185	720-2003H	184	730-2034H	186
701-86160	57	702-2026H	185	705-2006H	183	710-2036H	185	720-2004H	184	730-2035H	186
701-86161	57	702-2027H	185	705-2007H	183	710-2037H	185	720-2005H	184	730-2036H	186
701-86162	57	702-2028H	185	705-2008H	183	710-2038H	185	720-2006H	184	730-2037H	186
701-86163	57	702-2029H	185	705-2009H	183	710-2039H	185	720-2007H	184	730-2038H	186
701-86165	57	702-2030H	185	705-2010H	183	710-2040H	185	720-2008H	184	730-2039H	186
701-86167/68	57	702-2031H	185	705-2011H	183	710-2111H	183	720-2009H	184	730-2040H	186
701-87160	45	702-2032H	185	705-2012H	183	710-2112H	183	720-2010H	184	730-2111H	184
701-87161	45	702-2033H	185	705-2013H	183	710-2113H	183	720-2011H	184	730-2112H	184
701-87163	45	702-2034H	185	705-2014H	183	710-2114H	183	720-2012H	184	730-2113H	184
701-87165	45	702-2035H	185	705-2015H	183	710-2115H	183	720-2013H	184	730-2114H	184
701-87166	45	702-2036H	185	705-2016H	183	710-2116H	183	720-2014H	184	730-2115H	184
701-87167/68	45	702-2037H	185	705-2017H	185	710-2117H	183	720-2015H	184	730-2116H	184
701-95160	41	702-2038H	185	705-2018H	185	710-2118H	183	720-2016H	184	730-2117H	184
701-95161	41	702-2039H	185	705-2019H	185	710-2119H	183	720-2017H	186	730-2118H	184
701-95163	41	702-2040H	185	705-2020H	185	710-2120H	183	720-2018H	186	730-2119H	184
701-95165	41	702-2111H	183	705-2021H	185	710-2121H	183	720-2019H	186	730-2120H	184
701-95166	41	702-2112H	183	705-2022H	185	710-2504H	187	720-2020H	186	730-2121H	184
701-95180	41	702-2113H	183	705-2023H	185	710-2508H	187	720-2021H	186	740-2001H	184
701-95181	41	702-2114H	183	705-2024H	185	710-2512H	187	720-2022H	186	740-2002H	184
701-95183	41	702-2115H	183	705-2025H	185	710-2516H	187	720-2023H	186	740-2003H	184
701-95185	41	702-2116H	183	705-2026H	185	710-2520H	187	720-2024H	186	740-2004H	184
701-95186	41	702-2117H	183	705-2027H	185	710-2524H	187	720-2025H	186	740-2005H	184
701-550044	37	702-2118H	183	705-2028H	185	715-2001H	184	720-2026H	186	740-2006H	184
701-550065	49	702-2119H	183	705-2029H	185	715-2002H	184	720-2027H	186	740-2007H	184
701-555102	49	702-2120H	183	705-2030H	185	715-2003H	184	720-2028H	186	740-2008H	184
701-555142	49	703-2001H	183	705-2031H	185	715-2004H	184	720-2029H	186	740-2009H	184
701-555182	37	703-2002H	183	705-2032H	185	715-2005H	184	720-2030H	186	740-2010H	184
701-585162	37	703-2003H	183	705-2033H	185	715-2006H	184	720-2031H	186	740-2011H	184
701-585182	39	703-2004H	183	705-2034H	185	715-2007H	184	720-2032H	186	740-2012H	184
701-585192	39	703-2005H	183	705-2035H	185	715-2008H	184	720-2033H	186	740-2013H	184
701-587162	45	703-2006H	183	705-2036H	185	715-2009H	184	720-2034H	186	740-2014H	184
701-595162	41	703-2007H	183	705-2037H	185	715-2010H	184	720-2035H	186	740-2015H	184
701-595182	41	703-2008H	183	705-2038H	185	715-2011H	184	720-2036H	186	740-2016H	184
701i-12020H	148	703-2009H	183	705-2039H	185	715-2012H	184	720-2037H	186	740-2017H	186
701i-12023H	149	703-2010H	183	705-2040H	185	715-2013H	184	720-2038H	186	740-2018H	186
701i-12050H	148	703-2011H	183	705-2111H	183	715-2014H	184	720-2039H	186	740-2019H	186
701i-12053H	149	703-2012H	183	705-2112H	183	715-2015H	184	720-2040H	186	740-2020H	186
701i-18120H	148	703-2013H	183	705-2113H	183	715-2016H	184	720-2111H	184	740-2021H	186
701i-18123H	149	703-2014H	183	705-2114H	183	715-2017H	186	720-2112H	184	740-2022H	186
701i-18124H	149	703-2015H	183	705-2115H	183	715-2018H	186	720-2113H	184	740-2023H	186
701i-18210H	148	703-2016H	183	705-2116H	183	715-2019H	186	720-2114H	184	740-2024H	186
701i-18213H	149	703-2017H	185	705-2117H	183	715-2020H	186	720-2115H	184	740-2025H	186
701i-18214H	149	703-2018H	185	705-2118H	183	715-2021H	186	720-2116H	184	740-2026H	186
701i-34070H	111	703-2019H	185	705-2119H	183	715-2022H	186	720-2117H	184	740-2027H	186
701i-34120H	111	703-2020H	185	705-2120H	183	715-2023H	186	720-2118H	184	740-2028H	186
701i-34125H	111	703-2021H	185	705-2121H	183	715-2024H	186	720-2119H	184	740-2029H	186
701i-34126H	111	703-2022H	185	710-2001H	183	715-2025H	186	720-2120H	184	740-2030H	186
701i-34127H	111	703-2023H	185	710-2002H	183	715-2026H	186	730-2001H	184	740-2031H	186
701i-34128H	111	703-2024H	185	710-2003H	183	715-2027H	186	730-2002H	184	740-2032H	186
701i-341550HK	183	703-2025H	185	710-2004H	183	715-2028H	186	730-2003H	184	740-2033H	186
701i-34170H	111	703-2026H	185	710-2005H	183	715-2029H	186	730-2004H	184	740-2034H	186
701i-342550HK	184	703-2027H	185	710-2006H	183	715-2030H	186	730-2005H	184	740-2035H	186
701i-352010HK	183	703-2028H	185	710-2007H	183	715-2031H	186	730-2006H	184	740-2036H	186
701i-352050HK	184	703-2029H	185	710-2008H	183	715-2032H	186	730-2007H	184	740-2037H	186
701i-41550HK	148	703-2030H	185	710-2009H	183	715-2033H	186	730-2008H	184	740-2038H	186
701i-42550HK	148	703-2031H	185	710-2010H	183	715-2034H	186	730-2009H	184	740-2039H	186
702-2001H	183	703-2032H	185	710-2011H	183	715-2035H	186	730-2010H	184	740-2040H	186

Article No.	Page(s)	Article No.	Page(s)	Article No.	Page(s)	Article No.	Page(s)	Article No.	Page(s)	Article No.	Page(s)
740-2111H	184	760-2117H	184	785-2034H	197	815-2038	203	8461-32020H	209	864-2113	203
740-2112H	184	760-2118H	184	785-2036H	197	815-2039	203	8461-332050HK	209	8800-B200HK	216
740-2113H	184	760-2119H	184	785-2037H	197	815-2040	203	8461-34090H	209	8800-B600HK	216
740-2114H	184	760-2120H	184	785-2040H	197	815-2041	203	8461-342030H	209	8800-B611HK	216
740-2115H	184	760-2121H	184	785-2111H	195	815-2042	203	8461-342550HK	209	8800-B670HK	216
740-2116H	184	761-2001H	188, 195	785-2113H	195	815-2043	203	8461-342580HK	209	8801-B200HK	216
740-2117H	184	761-2002H	188, 195	785-2115H	195	815-2111	203	8461-38110H	209	8801-B600HK	216
740-2118H	184	761-2003H	188, 195	785-2117H	195	815-2113	203	8461-53150	33, 211	8801-B611HK	216
740-2119H	184	761-2004H	188, 195	785-2118H	195	81i-32020H	159	8461-53151	33, 211	8801-B670HK	216
740-2120H	184	761-2006H	188, 195	785-2119H	195	81i-32025H	160	8461-53159	33, 211	8802-B200HK	216
759-2001H	188, 195	761-2007H	188, 195	785-2120H	195	81i-32027H	160	8461-53320H	115, 211	8802-B600HK	216
759-2002H	188, 195	761-2008H	188, 195	786-2001H	195	81i-32050H	159	8461-53321H	115, 211	8802-B611HK	216
759-2003H	188, 195	761-2011H	188, 195	786-2002H	195	81i-32055H	160	8461-53322H	115, 211	8802-B670HK	216
759-2004H	188, 195	761-2015H	188, 195	786-2003H	195	81i-32057H	160	8461-53323H	115, 211	8803-B200HK	216
759-2006H	188, 195	761-2016H	188, 195	786-2004H	195	81i-38110H	159	8461-61061HK	211	8803-B600HK	216
759-2007H	188, 195	761-2019H	188, 197	786-2006H	195	81i-38115H	160	8461-7161H	209	8803-B611HK	216
759-2008H	188, 195	761-2023H	188, 197	786-2007H	195	81i-38116H	160	8461-B200HK	209	8803-B670HK	216
759-2011H	188, 195	761-2027H	188, 197	786-2008H	195	81i-38117H	160	8462-32020H	209	8804-B200HK	216
759-2015H	188, 195	761-2031H	188, 197	786-2011H	195	81i-38118H	160	8462-332050HK	209	8804-B600HK	216
759-2016H	188, 195	761-2034H	188, 197	786-2015H	195	8450-332050HK	209	8462-34090H	209	8804-B611HK	216
759-2019H	188, 197	761-2036H	188, 197	786-2016H	195	8450-342550HK	209	8462-342030H	209	8804-B670HK	216
759-2023H	188, 197	761-2037H	188, 197	786-2019H	197	8450-342557HK	210	8462-342550HK	209	8810-342030H	216
759-2027H	188, 197	761-2040H	188, 197	786-2023H	197	8450-B200HK	209	8462-342580HK	209	8810-7161H	216
759-2031H	188, 197	761-2111H	188, 195	786-2027H	197	8450-B600HK	209	8462-38110H	209	8810-B200HK	216
759-2034H	188, 197	761-2113H	188, 195	786-2031H	197	8450-B611HK	210	8462-53150	33, 211	8810-B600HK	216
759-2036H	188, 197	761-2115H	188, 195	786-2034H	197	8450-B612HK	210	8462-53151	33, 211	8811-342030H	216
759-2037H	188, 197	761-2117H	188, 195	786-2036H	197	8450-B773HK	210	8462-53159	33, 211	8811-7161H	216
759-2040H	188, 197	761-2118H	188, 195	786-2037H	197	8450-B774HK	210	8462-53320H	115, 211	8811-B200HK	216
759-2111H	188, 195	761-2119H	188, 195	786-2040H	197	8451-332050HK	209	8462-53321H	115, 211	8811-B600HK	216
759-2113H	188, 195	761-2120H	188, 195	786-2111H	195	8451-342550HK	209	8462-53322H	115, 211	8812-342030H	216
759-2115H	188, 195	763-2003H	188	786-2113H	195	8451-342557HK	210	8462-53323	211	8812-7161H	216
759-2117H	188, 195	763-2034H	188	786-2115H	195	8451-B200HK	209	8462-53323H	115	8812-B200HK	216
759-2118H	188, 195	763-2036H	188	786-2117H	195	8451-B600HK	209	8462-53510H	83	8812-B600HK	216
759-2119H	188, 195	763-2037H	188	786-2118H	195	8451-B611HK	210	8462-53511H	83	8813-342030H	216
759-2120H	188, 195	763-2040H	188	786-2119H	195	8451-B612HK	210	8462-53512H	83	8813-7161H	216
760-2001H	184	763-2111H	188	786-2120H	195	8451-B773HK	210	8462-61061HK	211	8813-B200HK	216
760-2002H	184	763-2115H	188	78i-32020H	159	8451-B774HK	210	8462-7161H	209	8813-B600HK	216
760-2003H	184	763-2118H	188	78i-32050H	159	8452-332050HK	209	8462-B200HK	209	8814-342030H	216
760-2004H	184	763-2120H	188	78i-38110H	159	8452-342550HK	209	8463-32020H	209	8814-7161H	216
760-2005H	184	764-2001H	195	806-2038	203	8452-342557HK	210	8463-332050HK	209	8814-B200HK	216
760-2006H	184	764-2002H	195	806-2042	203	8452-B200HK	209	8463-34090H	209	8814-B600HK	216
760-2007H	184	764-2003H	195	806-2111	203	8452-B600HK	209	8463-342030H	209	885-2008	203
760-2008H	184	764-2004H	195	806-2113	203	8452-B611HK	210	8463-342550HK	209	885-2023	203
760-2009H	184	764-2006H	195	81-37120	99	8452-B612HK	210	8463-342580HK	209	885-2038	203
760-2010H	184	764-2007H	195	81-37121	99	8452-B773HK	210	8463-38110H	209	885-2039	203
760-2011H	184	764-2008H	195	81-37122	99	8452-B774HK	210	8463-53150	33, 211	885-2040	203
760-2012H	184	764-2011H	195	81-37125	100	8453-332050HK	209	8463-53151	33, 211	885-2041	203
760-2013H	184	764-2015H	195	81-37126	100	8453-342550HK	209	8463-53159	33, 211	885-2042	203
760-2014H	184	764-2016H	195	81-37127	100	8453-342557HK	210	8463-53320H	115, 211	885-2043	203
760-2015H	184	764-2019H	197	81-37180	99	8453-B200HK	209	8463-53321H	115, 211	885-2111	203
760-2016H	184	764-2023H	197	81-37182	99	8453-B600HK	209	8463-53322H	115, 211	885-2113	203
760-2017H	186	764-2027H	197	81-37183	100	8453-B611HK	210	8463-53323H	115, 211	886-2008	203
760-2018H	186	764-2031H	197	81-37185	100	8453-B612HK	210	8463-7161H	209	886-2023	203
760-2019H	186	764-2034H	197	81-37188	99	8453-B773HK	210	8463-B200HK	209	886-2038	203
760-2020H	186	764-2036H	197	81-37189	100	8453-B774HK	210	8464-32020H	209	886-2039	203
760-2021H	186	764-2037H	197	810-2008	202	8454-332050HK	209	8464-332050HK	209	886-2040	203
760-2022H	186	764-2040H	197	810-2016	202	8454-342550HK	209	8464-34090H	209	886-2041	203
760-2023H	186	764-2111H	195	810-2023	202	8454-342557HK	210	8464-342030H	209	886-2042	203
760-2024H	186	764-2113H	195	810-2033	202	8454-B200HK	209	8464-342550HK	209	886-2043	203
760-2025H	186	764-2115H	195	810-2038	202	8454-B600HK	209	8464-342580HK	209	886-2111	203
760-2026H	186	764-2117H	195	810-2039	202	8454-B611HK	210	8464-38110H	209	886-2113	203
760-2027H	186	764-2118H	195	810-2040	202	8454-B612HK	210	8464-53150	33, 211	900-17112	97
760-2028H	186	764-2119H	195	810-2041	202	8454-B773HK	210	8464-53151	33, 211	900-17190	97
760-2029H	186	764-2120H	195	810-2042	202	8454-B774HK	210	8464-53159	33, 211	900-17191	97
760-2030H	186	77i-32020H	156	810-2043	202	8460-32020H	209	8464-53320H	115, 211	900-17193	97
760-2031H	186	77i-32050H	156	810-2111	202	8460-332050HK	209	8464-53321H	115, 211	900-17194	97
760-2032H	186	77i-38110H	156	810-2113	202	8460-34090H	209	8464-53322H	115, 211	900-17196	97
760-2033H	186	785-2001H	195	811-2038	202	8460-342030H	209	8464-53323H	115, 211	900-18190	97
760-2034H	186	785-2002H	195	811-2042	202	8460-342550HK	209	8464-7161H	209	900-18191	97
760-2035H	186	785-2003H	195	811-2111	202	8460-342580HK	209	8464-B200HK	209	900-18192	97
760-2036H	186	785-2004H	195	811-2113	202	8460-38110H	209	864-2008	203	900-18193	97
760-2037H	186	785-2006H	195	812-2038	202	8460-53150	33, 211	864-2016	203	900-18194	97
760-2038H	186	785-2007H	195	812-2042	202	8460-53151	33, 211	864-2023	203	900-18196	97
760-2039H	186	785-2008H	195	812-2111	202	8460-53159	33, 211	864-2033	203	900-34100	104
760-2040H	186	785-2011H	195	812-2113	202	8460-53320H	115, 211	864-2038	203	900-34105	104
760-2111H	184	785-2015H	195	813-2038	202	8460-53321H	115, 211	864-2039	203	900-34106	104
760-2112H	184	785-2016H	195	813-2042	202	8460-53322H	115, 211	864-2040	203	900-34107	104
760-2113H	184	785-2019H	197	813-2111	202	8460-53323H	115, 211	864-2041	203	900-34108	104
760-2114H	184	785-2023H	197	813-2113	202	8460-61061HK	211	864-2042	203	900-34109	104
760-2115H	184	785-2027H	197	815-2008	203	8460-7161H	209	864-2043	203	900-34110	104
760-2116H	184	785-2031H	197	815-2023	203	8460-B200HK	209	864-2111	203	900-34115	104

270 ARTICLE NUMBERS

Article No.	Page(s)	Article No.	Page(s)	Article No.	Page(s)	Article No.	Page(s)	Article No.	Page(s)	Article No.	Page(s)
900-34116	104	900044-55775	26	900588-34158H	105	9011-32080H	167	905-2021H	196	910-2001H	194
900-34117	104	900044-59420	25	900588-34159H	105	9011-32100H	167	905-2022H	196	910-2002H	194
900-34118	104	900044-59422	25	900588-55720	26	9011-34020H	169	905-2023H	196	910-2003H	194
900-34119	104	900044-59425	25	900588-55722	26	9011-34090H	167	905-2024H	196	910-2004H	194
900-37088	97	900044-59426	25	900588-55725	26	9011-38110H	166	905-2025H	196	910-2005H	194
900-37120	99	900044-59427	25	900588-55729	26	9011-42550HK	166	905-2026H	196	910-2006H	194
900-37121	99	900044-59428	25	900588-55730	25	9011-42580HK	167	905-2027H	196	910-2007H	194
900-37122	99	900044-59620	107	900588-55732	25	902-2001H	194	905-2028H	196	910-2008H	194
900-37125	100	900044-59627	107	900588-55735	25	902-2002H	194	905-2029H	196	910-2009H	194
900-37126	100	900044-59628	107	900588-55736	25	902-2003H	194	905-2030H	196	910-2010H	194
900-37127	100	900044-59629	107	900588-55737	25	902-2004H	194	905-2031H	196	910-2011H	194
900-37150	112	900044-59630	107	900588-55738	25	902-2005H	194	905-2032H	196	910-2012H	194
900-37155	112	900044-59637	107	900588-55740	27	902-2006H	194	905-2033H	196	910-2013H	194
900-37180	99	900044-59638	107	900588-55742	27	902-2007H	194	905-2034H	196	910-2014H	194
900-37182	99	900044-59639	107	900588-55745	27	902-2008H	194	905-2035H	196	910-2015H	194
900-37183	100	900044-510002	112	900588-55749	27	902-2009H	194	905-2036H	196	910-2016H	194
900-37185	100	900464-55450	92	900588-55760	26	902-2010H	194	905-2037H	196	910-2017H	196
900-37186	97	900464-55452	92	900588-55762	26	902-2011H	194	905-2038H	196	910-2018H	196
900-37188	99	900464-55455	92	900588-55765	26	902-2012H	194	905-2039H	196	910-2019H	196
900-37189	100	900464-55456	92	900588-55766	26	902-2013H	194	905-2040H	196	910-2020H	196
900-53130	106	900566-55450	92	900588-55770	26	902-2014H	194	905-2111H	194	910-2021H	196
900-53135	106	900566-55452	92	900588-55775	26	902-2015H	194	905-2112H	194	910-2022H	196
900-53136	106	900566-55455	92	900588-59420	25	902-2016H	194	905-2113H	194	910-2023H	196
900-53137	106	900566-55456	92	900588-59422	25	902-2017H	196	905-2114H	194	910-2024H	196
900-53138	106	900567-34146H	105	900588-59425	25	902-2018H	196	905-2115H	194	910-2025H	196
900-53139	106	900567-34147H	105	900588-59426	25	902-2019H	196	905-2116H	194	910-2026H	196
900-53150	32	900567-34148H	105	900588-59427	25	902-2020H	196	905-2117H	194	910-2027H	196
900-53151	32	900567-34149H	105	900588-59428	25	902-2021H	196	905-2118H	194	910-2028H	196
900-53159	32	900567-34156H	105	900588-59620	107	902-2022H	196	905-2119H	194	910-2029H	196
900-53190	106	900567-34157H	105	900588-59627	107	902-2023H	196	905-2120H	194	910-2030H	196
900-53195	106	900567-34158H	105	900588-59628	107	902-2024H	196	91-34306	111	910-2031H	196
900-53196	106	900567-34159H	105	900588-59629	107	902-2025H	196	91-34307	111	910-2032H	196
900-53197	106	900567-55720	26	900588-59630	107	902-2026H	196	91-34308	111	910-2033H	196
900-53198	106	900567-55722	26	900588-59637	107	902-2027H	196	91-34309	111	910-2034H	196
900-53199	106	900567-55725	26	900588-59638	107	902-2028H	196	91-37120	99	910-2035H	196
900-54420	116	900567-55729	26	900588-59639	107	902-2029H	196	91-37121	99	910-2036H	196
900-54421	116	900567-55730	25	900615-55450	92	902-2030H	196	91-37122	99	910-2037H	196
900-54422	116	900567-55732	25	900615-55452	92	902-2031H	196	91-37125	100	910-2038H	196
900-54423	116	900567-55735	25	900615-55455	92	902-2032H	196	91-37126	100	910-2039H	196
900-55440	92	900567-55736	25	900615-55456	92	902-2033H	196	91-37127	100	910-2040H	196
900-55442	92	900567-55737	25	900634-34136H	110	902-2034H	196	91-37150	112	910-2111H	194
900-55445	92	900567-55738	25	900634-34137H	110	902-2035H	196	91-37155	112	910-2112H	194
900-55446	92	900567-55740	27	900634-34138H	110	902-2036H	196	91-37180	99	910-2113H	194
900-55750	27	900567-55742	27	900634-34139H	110	902-2037H	196	91-37182	99	910-2114H	194
900-55752	27	900567-55745	27	900634-34166H	110	902-2038H	196	91-37183	100	910-2115H	194
900-55755	27	900567-55749	27	900634-34167H	110	902-2039H	196	91-37185	100	910-2116H	194
900-55759	27	900567-55760	26	900634-34168H	110	902-2040H	196	91-37188	99	910-2117H	194
900-55840	32	900567-55762	26	900634-34169H	110	902-2111H	194	91-37189	100	910-2118H	194
900-55841	32	900567-55765	26	900644-32059	112	902-2112H	194	91-53130	106	910-2119H	194
900-55845	32	900567-55766	26	900644-38119	112	902-2113H	194	91-53135	106	910-2120H	194
900039-55450	92	900567-55770	26	900659-32059	112	902-2114H	194	91-53136	106	918-37080	169
900039-55452	92	900567-55775	26	900659-38119	112	902-2115H	194	91-53137	106	918-37081	169
900039-55455	92	900567-59420	25	900671-34136H	110	902-2116H	194	91-53138	106	918-37082	169
900039-55456	92	900567-59422	25	900671-34137H	110	902-2117H	194	91-53139	106	918i-27180H	168
900044-34146H	105	900567-59425	25	900671-34138H	110	902-2118H	194	91-53150	32	918i-27181H	168
900044-34147H	105	900567-59426	25	900671-34139H	110	902-2119H	194	91-53151	32	918i-27182H	168
900044-34148H	105	900567-59427	25	900671-34166H	110	902-2120H	194	91-53159	32	918i-32020H	166
900044-34149H	105	900567-59428	25	900671-34167H	110	902R-54420	116	91-53190	106	918i-32050H	166
900044-34156H	105	900567-59620	107	900671-34168H	110	902R-54421	116	91-53195	106	918i-32080H	167
900044-34157H	105	900567-59627	107	900671-34169H	110	902R-54422	116	91-53196	106	918i-32100H	167
900044-34158H	105	900567-59628	107	900672-32059	112	902R-54423	116	91-53197	106	918i-34020H	169
900044-34159H	105	900567-59629	107	900672-38119	112	905-2001H	194	91-53198	106	918i-34090H	167
900044-55720	26	900567-59630	107	900673-32059	112	905-2002H	194	91-53199	106	918i-34306H	169
900044-55722	26	900567-59637	107	900673-38119	112	905-2003H	194	91-53320H	114	918i-38110H	166
900044-55725	26	900567-59638	107	900674-55450	92	905-2004H	194	91-53321H	114	918i-42550HK	166
900044-55729	26	900567-59639	107	900674-55452	92	905-2005H	194	91-53322H	114	918i-42580HK	167
900044-55730	25	900567-510002	112	900674-55455	92	905-2006H	194	91-53323H	114	91i-32020H	155
900044-55732	25	900568-34136H	110	900674-55456	92	905-2007H	194	91-54420	116	91i-32025H	157
900044-55735	25	900568-34137H	110	900713-342555HK	210	905-2008H	194	91-54421	116	91i-32027H	157
900044-55736	25	900568-34138H	110	900714-342555HK	210	905-2009H	194	91-54422	116	91i-32050H	155
900044-55737	25	900568-34139H	110	900719-342555HK	210	905-2010H	194	91-54423	116	91i-32055H	157
900044-55738	25	900568-34166H	110	900725-342555HK	210	905-2011H	194	91-55520	93	91i-32057H	157
900044-55740	27	900568-34167H	110	900726-342555HK	210	905-2012H	194	91-55522	93	91i-34070H	111
900044-55742	27	900568-34168H	110	901-37080	169	905-2013H	194	91-55526	93	91i-34100H	104
900044-55745	27	900568-34169H	110	901-37081	169	905-2014H	194	91-55750	27	91i-34105H	104
900044-55749	27	900588-34146H	105	901-37082	169	905-2015H	194	91-55752	27	91i-34106H	104
900044-55760	26	900588-34147H	105	901i-27180H	168	905-2016H	194	91-55755	27	91i-34107H	104
900044-55762	26	900588-34148H	105	901i-27181H	168	905-2017H	196	91-55759	27	91i-34108H	104
900044-55765	26	900588-34149H	105	901i-27182H	168	905-2018H	196	91-55840	32	91i-34109H	104
900044-55766	26	900588-34156H	105	901i-32020H	166	905-2019H	196	91-55841	32	91i-34110H	104
900044-55770	26	900588-34157H	105	901i-32050H	166	905-2020H	196	91-55845	32	91i-34115H	104

Article No.	Page(s)	Article No.	Page(s)
91i-34116H	104	980-2011H	194
91i-34117H	104	980-2015H	194
91i-34118H	104	980-2019H	196
91i-34119H	104	980-2023H	196
91i-34120H	111	980-2027H	196
91i-34125H	111	980-2031H	196
91i-34126H	111	980-2039H	196
91i-34127H	111	980-2111H	194
91i-34128H	111	980-2118H	194
91i-38110H	155	980-2120H	194
91i-38115H	157	F-190	57
91i-38116H	157		
91i-38117H	157		
91i-38118H	157		
920-2001H	194		
920-2002H	194		
920-2003H	194		
920-2004H	194		
920-2005H	194		
920-2006H	194		
920-2007H	194		
920-2008H	194		
920-2009H	194		
920-2010H	194		
920-2011H	194		
920-2012H	194		
920-2013H	194		
920-2014H	194		
920-2015H	194		
920-2016H	194		
920-2017H	196		
920-2018H	196		
920-2019H	196		
920-2020H	196		
920-2021H	196		
920-2022H	196		
920-2023H	196		
920-2024H	196		
920-2025H	196		
920-2026H	196		
920-2027H	196		
920-2028H	196		
920-2029H	196		
920-2030H	196		
920-2031H	196		
920-2032H	196		
920-2033H	196		
920-2034H	196		
920-2035H	196		
920-2036H	196		
920-2037H	196		
920-2038H	196		
920-2039H	196		
920-2040H	196		
920-2111H	194		
920-2112H	194		
920-2113H	194		
920-2114H	194		
920-2115H	194		
920-2116H	194		
920-2117H	194		
920-2118H	194		
920-2119H	194		
920-2120H	194		
926-37080	169		
926-37081	169		
926-37082	169		
926i-27180H	168		
926i-27181H	168		
926i-27182H	168		
926i-32020H	166		
926i-32050H	166		
926i-32080H	167		
926i-32100H	167		
926i-34020H	169		
926i-34090H	167		
926i-38110H	166		
926i-42550HK	166		
926i-42580HK	167		
980-2003H	194		
980-2007H	194		

272 INDEX ACCORDING TO MODELS

Model	Series	Page(s)
1 x 1 cm	3/8 x 3/8 Inch	
	Plural	170
ø 1 cm	3/8 Inch	
	Loop	238
2.5 x 2.5 cm	1 x 1 Inch	
	Fresh	224
	Plural	170
	Plural non-slip	190
	Plural unglazed	198
ø 2 cm	6/8 Inch	
	Loop	238
5 x 5 cm	2 x 2 Inch	
	Ascona	128
	Fresh	224
	Plural	170
	Plural non-slip	190
	Plural unglazed	198
	Quarzit	204
	Savona	212
6 x 50 cm	2 3/8 x 20 Inch	
	Ascona	128
	Quarzit	204
6 x 60 cm	2 3/8 x 24 Inch	
	Ascona	128
	Quarzit	204
	Savona	212
6.2 x 25 cm	2 1/2 x 10 Inch	
	Chroma	142
	Chroma unglazed	162
7.9 x 25 cm	3 1/8 x 10 Inch	
	Chroma unglazed	162
10 x 10 cm	4 x 4 Inch	
	Plural	170
	Plural non-slip	190
	Plural unglazed	198
10 x 20 cm	4 x 8 Inch	
	Plural	170
10 x 25 cm	4 x 10 Inch	
	Ascona	128
10 x 30 cm	4 x 12 Inch	
	Plural	170
10 x 40 cm	4 x 16 Inch	
	Plural	170
10 x 50 cm	4 x 20 Inch	
	Ascona	128
10 x 60 cm	4 x 24 Inch	
	Ascona	128
	Plural	170
	Quarzit	204
12.5 x 3.3 cm	5 x 1 3/8 Inch	
	Special Tiles	108
12.5 x 6.2 cm	5 x 2 1/2 Inch	
	Special Tiles	108
12.5 x 12.5 cm	5 x 5 Inch	
	Ascona	128
	Chroma	142
	Chroma non-slip	152
	Chroma unglazed	162
	Quarzit	204
	Grooved Tiles	102
	Special Tiles	108
12.5 x 15.6 cm	5 x 6 1/4 Inch	
	Grooved Tiles	102
	Special Tiles	108

Model	Series	Page(s)
12.5 x 25 cm	5 x 10 Inch	
	Ascona	128
	Pool Edge System Finland II	28
	Chroma	142
	Chroma non-slip	152
	Chroma unglazed	162
	Quarzit	204
12.5 x 50 cm	5 x 20 Inch	
	Chroma	142
	Plural	170
12.5 x 100 cm	5 x 40 Inch	
	Plural	170
15 x 15 cm	6 x 6 Inch	
	Ascona	128
	Plural	170
	Plural unglazed	198
	Quarzit	204
	Savona	212
15 x 30 cm	6 x 12 Inch	
	Plural	170
20 x 7.9 cm	8 x 3 1/8 Inch	
	Skirtings Profiled edgings	94
20 x 10 cm	8 x 4 Inch	
	Skirtings Profiled edgings	94
20 x 20 cm	8 x 8 Inch	
	Plural	170
	Plural non-slip	190
	Plural unglazed	198
20 x 40 cm	8 x 16 Inch	
	Plural	170
25 x 3.3 cm	10 x 1 3/8 Inch	
	Special Tiles	108
25 x 6.2 cm	10 x 2 1/2 Inch	
	Skirtings Profiled edgings	94
	Special Tiles	108
25 x 6.6 cm	10 x 2 5/8 Inch	
	Skirtings Profiled edgings	94
25 x 7.9 cm	10 x 3 1/8 Inch	
	Skirtings Profiled edgings	94
25 x 12.5 cm	10 x 5 Inch	
	Skirtings Profiled edgings	94
	Grooved Tiles	102
	Special Tiles	108
25 x 15.6 cm	10 x 6 1/4 Inch	
	Grooved Tiles	102
	Special Tiles	108
25 x 25 cm	10 x 10 Inch	
	Ascona	128
	Pool Edge System Finland II	28
	Chroma	142
	Chroma non-slip	152
	Chroma unglazed	162
	Quarzit	204
	Special Tiles	108
25 x 30 cm	10 x 12 Inch	
	Pool Edging Tiles	90
25 x 50 cm	10 x 20 Inch	
	Ascona	128
	Chroma	142
	Chroma unglazed	162
	Ceramic Channel Cover 2.0	80
	Plural	170
	Quarzit	204
	Special Tiles	108

Model	Series	Page(s)
28 x 145 cm	11 3/16 x 58	
	Quarzit	204
30 x 7.9 cm	12 x 3 1/8 Inch	
	Skirtings Profiled edgings	94
30 x 30 cm	12 x 12 Inch	
	Ceramic Channel Cover 2.0	80
	Plural	170
30 x 60 cm	12 x 24 Inch	
	Ascona	128
	Plural	170
	Plural non-slip	190
	Plural unglazed	198
	Quarzit	204
	Savona	212
31 x 145 cm	12 3/8 x 58 Inch	
	Ascona	128
	Quarzit	204
50 x 25 cm	20 x 10 Inch	
	Ascona	128
	Pool Edge System Finland II	28
	Quarzit	204
	Special Tiles	108
50 x 100 cm	20 x 40 Inch	
	Ascona	128
	Plural	170
60 x 60 cm	24 x 24 Inch	
	Quarzit	204
	Savona	212
60 x 90 cm	24 x 36 Inch	
	Ascona	128
60 x 120 cm	24 x 48 Inch	
	Savona	212

Model No.	Page(s)	Model No.	Page(s)	Model No.	Page(s)	Model No.	Page(s)	Model No.	Page(s)
12020H	148, 150, 151	34156H	105	53136	106	55722	26	730	184, 186
12023H	149	34157H	105	53137	106	55725	26	760	184, 186
12050H	148, 150, 151	34158H	105	53138	106	55729	26	85160	37
12053H	149	34159H	105	53139	106	55730	25	85161	37
17112	97	34166H	110	53150	32, 33, 211	55732	25	85163	37
17190	97	34167H	110	53151	32, 33, 211	55735	25	85165	37
17191	97	34168H	110	53159	32, 33, 211	55736	25	85166	37
17193	97	34169H	110	53190	106	55737	25	85167	37, 41
17194	97	34170H	111	53195	106	55738	25	85180	39
17196	97	342030H	209, 216	53196	106	55740	27	85181	39
18120H	148, 150, 151	342550HK	184, 186, 209	53197	106	55742	27	85183	39
18123H	149	342555HK	210	53198	106	55745	27	85185	39
18124H	149	342557HK	210	53199	106	55749	27	85186	39
18190	97	342580HK	209	53320	114, 115, 211	55750	27	85187	39
18191	97	34306	111	53321	114, 115, 211	55752	27	85190	39
18192	97	34306H	169	53322	114, 115, 211	55755	27	85191	39
18193	97	34307	111	53323	114, 115, 211	55759	27	85193	39
18194	97	34308	111	53510	83	55760	26	85195	39
18196	97	34309	111	53510H	83	55762	26	85196	39
18210H	148, 150, 151	352010HK	183, 185	53511	83	55765	26	85197	39
18213H	149	352050HK	184, 186	53511H	83	55766	26	86160	57
18214H	149	37011	113	53512	83	55770	26	86161	57
27180H	168	37015	113	53512H	83	55775	26	86162	57
27181H	168	37017	113	54420	116	55800	93	86163	57
27182H	168	37018	113	54421	116	55802	93	86165	57
32020H	155, 156, 159, 166, 209	37021	98	54422	116	55805	93	86167	57
32025H	157, 160	37023	98	54423	116	55806	93	87160	45
32027H	157, 160	37024	98	55100	49	55820	31	87161	45
32050H	155, 156, 159, 166	37031	113	55101	49	55821	31	87163	45
32055H	157, 160	37035	113	55105	49	55822	31	87165	45
32057H	157, 160	37080	98, 169	55106	49	55825	31	87166	45
32059	112	37081	98, 169	55107	49	55826	31	87167	45
32080H	167	37082	98, 169	55140	49	55830	31	95160	41
32100H	167	37088	97	55141	49	55831	31	95161	41
332050HK	209	37090	98	55143	49	55832	31	95163	41
34020	98	37091	98	55145	49	55835	31	95165	41
34020H	169	37092	98	55146	49	55836	31	95166	41
34070H	111	37120	99	55147	49	55840	32	95180	41
34090H	167, 209	37121	99	55180	37	55841	32	95181	41
34100	104	37122	99	55181	37	55845	32	95183	41
34105	104	37125	100	55185	37	55850	57	95185	41
34106	104	37126	100	55186	37	55852	57	95186	41
34107	104	37127	100	55187	37, 41	55855	57	B200HK	209, 216
34108	104	37150	112	55440	92	55856	57	B600HK	209, 216
34109	104	37155	112	55442	92	55857	57	B611HK	210, 216
34110	104	37180	99	55445	92	59420	25	B612HK	210
34115	104	37182	99	55446	92	59422	25	B670HK	216
34116	104	37183	100	55450	92	59425	25	B773HK	210
34117	104	37185	100	55452	92	59426	25	B774HK	210
34118	104	37186	97	55455	92	59427	25	S10002	112
34119	104	37188	99	55456	92	59428	25	S50044	37
34120H	111	37189	100	55460	93	59620	107	S50065	49
34125H	111	38110H	155, 156, 159, 166, 209	55462	93	59627	107	S55102	49
34126H	111	38115H	157, 160	55465	93	59628	107	S55142	49
34127H	111	38116H	157, 160	55466	93	59629	107	S55182	37
34128H	111	38117H	157, 160	55520	93	59630	107	S85162	37
34136H	110	38118H	157, 160	55522	93	59637	107	S85182	39
34137H	110	38119	112	55526	93	59638	107	S85192	39
34138H	110	41550HK	148, 150, 151	55561	112	59639	107	S87162	45
34139H	110	42550HK	148, 150, 151, 166	55562	112	59680	113	S95162	41
34146H	105	42580HK	167	55563	112	59681	113	S95182	41
34147H	105	44025	98	55565	112	59685	113		
34148H	105	44026	98	55566	112	61061HK	211		
34149H	105	53130	106	55567	112	703	183, 185		
341550HK	183, 185	53135	106	55720	26	7161H	209, 216		

AGROB BUCHTAL offers tiles with overglazed edges in many series. In the case of glazed **earthenware tiles**, they are included in the bundles at a certain quantity as overglazed edges are almost always required for applications of these materials. In the case of **split tiles**, overglazed or overglazed *rounded* edges are available upon request according to the following model number system:

Last figure 0 of model no. to be replaced by1 = Short edge	...2 = Longitudinal edge	...3 = Corner left	...4 = Corner right	overglazed edges
	...5 = Short edge	...6 = Longitudinal edge	...7 = Corner left	...8 = Corner right	overglazed rounded edges (bullnoses)

Example: Standard model no. 18120 = 244 x 119 x 6 mm,
model no. 18123 = overglazed corner left

Area Pro

Color	similar to NCS no.	similar to RAL no.	Color Shade Variation
anthracite	S7502-B	7024	V2
basalt	S7005-B80G	180 4005	V2
pebble	S3502-Y	7030	V2
stone	S2502-Y	100 7005	V2
sand-white	S1502-Y50R	080 8005	V2
sand-grey	S1502-Y50R	080 7005	V2
sand	S5005-Y20R	075 5010	V2
nutmeg	S7005-Y50R	060 4005	V2
platinum	S0500-N	8500	V2
sand-beige	S1005-Y50R	060 8010	V2
brick	S7010-Y30R	060 4010	V2
clay	S8010-Y50R	050 3010	V2

Chroma and Plural

Color	similar to NCS no.	similar to RAL no.	Lightness Value Y
neutral 1 (Chroma unglazed)	S9000-N	9017	3
neutral 1	8000	7016	6
neutral 2	S7500-N	7015	9
neutral 3	S6500-N		15
neutral 4	S6000-N	7037	18
neutral 5	S5502-B	7046	21
neutral 6	S4502-B	7045	25
neutral 7	S4000-N	7004	33
neutral 8	S2502-B		46
neutral 9	S1502-R50B		65
neutral 10 (Chroma, Plural)	S1000-N	9003	76
neutral 10 (Chroma unglazed)	0502-Y	9001	66
neutral 10 (white glossy)	S1500	9003	70
active azure	S5030-R80B	5000	9
light azure	S2030-R80B		37
medium azure	S4030-R90B		21
dark azure	S4040-R90B	5007	13
active blue	S6030-R90B		7
light blue	S1510-R80B		60
medium blue	S2020-R80B		40
dark blue	S4030-R80B		17
active turquoise	S4030-B50G	6033	22
light turquoise	S1010-B50G		63
medium turquoise	S2020-B30G		44
dark turquoise	S4020-B30G		26
active green	S3050-G50Y		26
light green	S0510-G		69
medium green	S1515-G20Y	6019	53
dark green	S3020-G10Y	6021	31
active yellow	S3050-Y10R		32
light yellow	S1010-Y10R	1015	69
medium yellow	S2030-Y10R		50
dark yellow	S2050-Y20R		33
active ochre	S3050-Y40R		20
light ochre	S2030-Y20R		48
medium ochre	S3030-Y30R		36
dark ochre	S4030-Y50R		21
active salmon	S4040-Y70R		15
light salmon	S1515-Y50R		51
medium salmon	S2020-Y50R		39
dark salmon	S3040-Y60R		23
active oxide red	S4050-Y90R		10
light oxide red	S2010-Y80R		46
medium oxide red	S3020-Y80R		25
dark oxide red	S5020-Y80R		15
active stone grey	S5030-Y90R		9
light stone grey	S2502-R		46
medium stone grey	S3502-R	7036	34
dark stone grey	S6005-Y80R		15
active sand grey	S7010-Y90R		8
light sand grey	S1502-Y		56
medium sand grey	S3005-Y50R		35
dark sand grey	S6010-Y50R		14

Special colors

Color	similar to NCS no.	similar to RAL no.	Lightness Value Y
apple green	S1060-G40Y		39
medium brown	S5020-Y50R	060 50 20	17
medium grey	S3502-Y	100 70 05	32
intense blue	6040-R70B		1
contrasting red (Chroma non-slip B)	S2050-Y90R	3017	14
contrasting red (Chroma non-slip C)	S2060-Y90R	3018	15
contrasting red (Chroma)	S2570-Y90R	3002	10
natural white	2005-Y20R	7032	51
orange	S2060-Y50R	2010	24
medium sand	S1010-Y20R	1001	44
deep anthracite	S6010-R90B	260 40 05	8
deep blue	S4050-R70B	290 30 35	8
deep yellow	S0560-Y	085 80 70	52
deep green	S6020-G30Y	140 40 20	11
deep orange	S2060-Y60R	040 50 50	24
deep red	S1080R	030 40 50	11
violet	S5020-R50B	4001	13
lemon yellow	1070-Y	1016	52

The use of color as an architectural design means has gained increasing importance during the last years. Therefore, we provide you with a list of the relevant Agrob Buchtal design series in order to facilitate planning. It classifies the colors according to:

NCS = Natural Color System

(More detailed information can be obtained from: Scandinavian Color Institute AB, P.O.Box 49022 · S-10028 Stockholm · Phone +46/8/6174700 · Fax +46/8/6174747, Institut für Farbe – Brigitte Hartmann · Rotes Knie 6 · 74389 Cleebrohn Phone 07135/12742 · Fax 07135/12737)

RAL Color Chart

(More detailed information can be obtained from: RAL - Deutsches Institut für Gütesicherung und Kennzeichnung e.V. · Siegburger Straße 39 · D-53757 St. Augustin Phone +49 (0) 2241/1605-0 · Fax +49 (0) 2241/1605-11)

Lightness Value:

This figure (standard color value Y) describes the lightness of a color in comparison with an ideally white surface if illuminated under identical light conditions, i. e. same intensity, direction and quality. For an ideal white, which means that all the incident light is reflected, the value Y = 100 applies (black: Y = 0).

Please note that these classifications may only serve as an orientation aid. Original samples will be made available to you upon request.

The difference in lightness of two adjoining colored surfaces is called luminance contrast. By means of this value, one can determine whether a room design is rich in contrast, as it is required, for example, by DIN 32975 "Designing visual information in the public area for accessible use". In the following, you will find the relevant values for selected

series. They result from the respective lightness values, which are indicated as averaged values of individual measurements. We will be pleased to determine values for other products upon request.

Luminance contrast Series Area Pro										
		anthracite	basalt	pebble	stone	sand-white	sand-grey	sand	nutmeg	
<i>Lightness Value Y</i>		8	13	21	33	50	38	21	14	
anthracite	8	0.00	0.23	0.44	0.60	0.72	0.64	0.44	0.24	
basalt	13		0.00	0.23	0.43	0.59	0.49	0.24	0.01	
pebble	21			0.00	0.22	0.41	0.29	0.01	0.22	
stone	33				0.00	0.21	0.08	0.21	0.42	
sand-white	50					0.00	0.14	0.40	0.58	
sand-grey	38						0.00	0.28	0.48	
sand	21							0.00	0.23	
nutmeg	14								0.00	
platinum	58									
sand-beige	41									
brick	14									
clay	10									

Luminance contrast Series Ascona							
		shell	sand	pearl	stone	mud	graphite
<i>Lightness Value Y</i>		55	50	47	40	27	11
shell	55	0.00					
sand	50	0.05	0.00				
pearl	47	0.08	0.03	0.00			
stone	40	0.16	0.11	0.08	0.00		
mud	27	0.34	0.30	0.27	0.19	0.00	
graphite	11	0.67	0.64	0.62	0.57	0.42	0.00

Luminance contrast Series Area Pro (continuation)

		platinum	sand-beige	brick	clay
<i>Lightness Value Y</i>		58	41	14	10
anthracite	8	0.75	0.66	0.25	0.07
basalt	13	0.63	0.51	0.03	0.16
pebble	21	0.47	0.32	0.21	0.38
stone	33	0.28	0.11	0.41	0.55
sand-white	50	0.07	0.11	0.57	0.68
sand-grey	38	0.21	0.04	0.47	0.60
sand	21	0.46	0.31	0.21	0.38
nutmeg	14	0.62	0.50	0.01	0.17
platinum	58	0.00	0.18	0.62	0.72
sand-beige	41		0.00	0.49	0.62
brick	14			0.00	0.19
clay	10				0.00

Luminance contrast Series Quarzit

		basalt-grey	quarz-grey	sand-beige	sepia-brown	white-grey
<i>Lightness Value Y</i>		15	40	47	30	55
basalt-grey	15	0.00				
quarz-grey	40	0.45	0.00		0.14	
sand-beige	47	0.52	0.08	0.00	0.22	
sepia-brown	30	0.33			0.00	
white-grey	55	0.57	0.16	0.08	0.29	0.00

Luminance contrast Series Savona

		chalk	beige	brown	grey	anthracite
<i>Lightness Value Y</i>		52	38	20	20	8
chalk	52	0.00	0.16	0.44	0.44	0.73
beige	38		0.00	0.31	0.31	0.65
brown	20			0.00	0.00	0.43
grey	20			0.00	0.00	0.43
anthracite	8					0.00



European Quality Standards

Product Standards (simplified and based on 20 x 20 cm (BIII), or 30 x 30 cm (BI))	Extruded Ceramic Tiles DIN EN 14411		Dry-pressed Ceramic Tiles DIN EN 14411		Test Standards
	group AI _a + AI _b „Nature“ „Precision“	group AII _a - part 1 „Nature“ „Precision“	group BI _a + BI _b	group BIII	
A) Dimensions + Surfaces					
1. Length and Width	± 2% ± 1.0%	± 2% ± 1.25%	± 0.6%	± 0.5%	DIN EN ISO 10545-2
2. Thickness	± 10% ± 10%	± 10% ± 10%	± 5%	± 10%	DIN EN ISO 10545-2
3. Straightness of Edges	± 0.6% ± 0.5%	± 0.6% ± 0.5%	± 0.5%	± 0.3%	DIN EN ISO 10545-2
4. Rectangularity	± 1.0% ± 1.0%	± 1.0% ± 1.0%	± 0.5%	± 0.5%	DIN EN ISO 10545-2
5. Surface Flatness					DIN EN ISO 10545-2
5.1 Curvature at Centre	± 1.5% ± 0.5%	± 1.5% ± 0.5%	± 0.5%	+ 0.5/-0.3%	DIN EN ISO 10545-2
5.2 Curvature at the Edges	± 1.5% ± 0.5%	± 1.5% ± 0.5%	± 0.5%	+ 0.5/-0.3%	DIN EN ISO 10545-2
5.3 Skewness	± 1.5% ± 0.8%	± 1.5% ± 0.8%	± 0.5%	± 0.5%	DIN EN ISO 10545-2
6. Surface Quality	at least 95%	at least 95%	at least 95%	at least 95%	DIN EN ISO 10545-2
7. Color Deviations	•	•	•	•	DIN EN ISO 10545-16
7.1 Color Shade Grading	•	•	•	•	Deutsche Steinzeug
8. Size Grading ¹⁾	•	•	•	•	Deutsche Steinzeug
B) Physical Properties				glazed	
1. Water Absorption on average / max. individual value	AI _a E ≤ 0.5%/0.6% AI _b 0.5% < E ≤ 3%/3.3%	≤ 6/6.5%	BI _a ≤ 0.5% BI _b ≤ 3%	> 10%	DIN EN ISO 10545-3
2. Modulus of Rupture	AI _a min. 28 (21)N/mm ² AI _b min. 23 (18)N/mm ²	min. 20 (18)N/mm ²	BI _a min. 35 (32) N/mm ² BI _b min. 30 (27) N/mm ²	Thickness<7.5mm:15N/mm ² Thickness≥7.5mm:12N/mm ²	DIN EN ISO 10545-4
2.1 Breaking Strength ≥ 7,5 mm thickness	AI _a min. 1300 N AI _b min. 1100 N	at least 950 N	BI _a min. 1300 N BI _b min. 1100 N	at least 600 N	DIN EN ISO 10545-4
2.2 Break. Str. < 7,5 mm thickness	at least 600 N	at least 600 N	at least 700 N	at least 200 N	DIN EN ISO 10545-4
3. Resistance to Shock	•	•	•	•	DIN EN ISO 10545-5
4. Resistance to Deep Abrasion	≤ 275 mm ³	≤ 393 mm ³	≤ 175 mm ³	–	DIN EN ISO 10545-6
5. Resistance to Glaze Abrasion	0-5	0-5	0-5	0-5	DIN EN ISO 10545-7
6. Max. Coefficient of Expansion	•	•	•	•	DIN EN ISO 10545-8
7. Thermal Shock Resistance	•	•	•	•	DIN EN ISO 10545-9
8. Moisture Expansion	< 0.001 mm/m	< 0.001 mm/m	appr. 0.001 mm/m	appr. 0.01 mm/m	DIN EN ISO 10545-10
9. Resistance to Glaze Cracking	required	required	required	required	DIN EN ISO 10545-11
10. Thermal Conductivity	appr. 1 W/mK	appr. 1 W/mK	appr. 1 W/mK	appr. 0,8 W/mK	Deutsche Steinzeug
11. Electrical Leakage Resistance	> 10 ¹⁰ Ohm ³⁾	> 10 ¹⁰ Ohm ³⁾	10 ¹⁰ Ohm	10 ¹⁰ Ohm	DIN EN 1081
12. Steam Diffusion Resistance	appr. μ 120,000	appr. μ 120,000	appr. μ 120,000	appr. μ 100,000	DIN EN ISO 12572
13. Resistance to Frost	required	not required, but met by AGROB BUCHTAL	required	–	DIN EN ISO 10545-12
14. Light an Color Fastness	•	•	•	•	DIN 51094
15. Luminance	acc. to specifications	acc. to specifications	acc. to specifications	acc. to specifications	Deutsche Steinzeug
16. Behaviour in Fire	A1/A1 _{fl}	A1/A1 _{fl}	A1/A1 _{fl}	A1/A1 _{fl}	DIN 4102/DIN EN 13501-1
C) Chemical Properties²⁾					
1. Resistance to Chemicals	see test certificate	see test certificate	see test certificate	see test certificate	DIN EN ISO 10545-13
2. Resistance to Household Chemicals and Bath Water Additives	min. GB or UB	min. GB or UB	min. GB or UB	–	
3. Stain Resistance (glazed)	min. Kl. 3	min. Kl. 3	min. Kl. 3	min. Kl. 3	DIN EN ISO 10545-14
4. Lead and Cadmium Delivery	•	•	•	•	DIN EN ISO 10545-15
5. Hytect	see test certificate	see test certificate	see test certificate	see test certificate	Deutsche Steinzeug
D) Slip resistance					
1. Coefficient of Friction	•	•	•	–	E-DIN EN ISO 10545-17
1.1 Industrial Areas (BG) Trade Associations	Groups R9-13/V4-10	Groups R9-13/V4-10	Groups R9-13/V4-10	–	DIN EN 16165, Annex B DGUV-R 108-003 (BGR 181)
1.2 Barefoot Areas (BUK) German National Association of Accident Insurance Companies	Groups A/B/C	Groups A/B/C	Groups A/B/C	–	DIN EN 16165, Annex A DGUV-I 207-006 (GUV-I 8527)

1) Boxes marked according to size and color shade.

2) Hydrofluoric acid and its compounds excluded.

3) Exceptions:

KerAion ELA 10.6: Electrical Leakage Resistance 10⁹ Ohm (DIN EN 1081)

Eladuct 10⁸

All references to as well as quotations from product and test standards are to be considered as information which is not binding. The latest versions apply.

Deutsche Steinzeug tiles present better values than required by the standards.

In addition, they are construction biologically, ecologically, hygienically and bacteriologically safe; this is guaranteed through the choice of raw materials, method of processing and firing technique.

Terms and Classification according to DIN EN 14411

All our tiles consist of natural raw materials such as clay, quartz sand and feldspars, which are processed, refined and fired. Depending on the application they are manufactured with a glazed (GL) or unglazed (UGL) surface. They can be classified in accordance with DIN EN 14411 as follows:

Classification of the ceramic tiles according to their groups of water absorption (E) and their shaping

Shaping	Group I E ≤ 3%	Group II _a 3% < E ≤ 6%	Group II _b 6% < E ≤ 10%	Group III E > 10%
A extruded tiles	Group AI _a E ≤ 0.5% (Annex M)	Group All _{a-1} ^{a)} (Annex B)	Group All _{b-1} ^{a)} (Annex D)	Group All (Annex F)
	Group AI _b 0.5% < E ≤ 3% (Annex A)	Group All _{a-2} ^{a)} (Annex C)	Group All _{b-2} ^{a)} (Annex E)	
B dry-pressed tiles	Group BI _a E ≤ 0.5% (Annex G)	Group BII _a (Annex J)	Group BII _b (Annex K)	Group BIII _b (Annex L)
	Group BI _b 0.5% < E ≤ 3% (Annex H)			
a) The groups All _a and All _b are subdivided into two parts (parts 1 and 2) with different product requirements. b) Group BIII essentially applies to glazed tiles. There is a small number of dry-pressed unglazed tiles manufactured with a water absorption of more than 10% to which this product group does not apply.				

Traditionally the following terms are used:

Extruded tiles

(marked with A)

Tiles that are cut off with a certain length from a bar formed from the plastic mass by means of an extruder.

Dry-pressed tiles

(marked with B)

Tiles that are formed from a finely ground and subsequently granulated mass by pressing under high pressure.

Split tiles are frost-resistant, extruded double-tiles which are fired at a temperature of up to max. 1280 °C in upright position.

Stoneware tiles are frost-resistant, single extruded vitrified tiles with a firing temperature of appr. 1260 °C.

KerAion is the unique extruded ceramic large-size panel from AGROB BUCHTAL.

Vitrified dry-pressed tiles are frost-resistant, single dry-pressed tiles with a firing temperature of up to 1200 °C.

Porcelain stoneware stands for especially densely sintered tiles with a water absorption of < 0.5 %.

Mosaics are small (porcelain) stoneware tiles stuck onto sheets.

Earthenware tiles are non-frost-resistant, single dry-pressed tiles with a firing temperature of up to appr. 1100 °C.

The water absorption E in weight-% is determined in accordance with DIN EN ISO 10545-3.

Description of dimensions

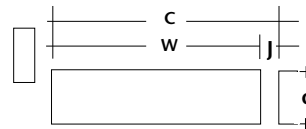

Coordinating dimension (C) in cm = Work size (W) + joint (J)

Work size (W) in mm = Dimensions of the visible surfaces and thickness (d)

Dimensions and Surfaces

1-5. Dimensions, DIN EN ISO 10545-2

All dimensions are determined in accordance with the standard.

Permissible length and width tolerances corresponding to the product standards						
DIN EN 14411	Group AI _a / AI _b (25x12.5 cm)		Group All _a (25x12.5 cm)		Group BI _a / BI _b (30x30 cm)	Group BIII (10x10 cm)
	„Nature“	„Precision“	„Nature“	„Precision“		
Deviation from the work size	± 2%, max. 4 mm	± 1%, max. 2 mm	± 2%, max. 4 mm	± 1.25%, max. 2 mm	± 0.6%, max. 2 mm	± 0.2%, max. 2 mm
Deviation from the average side length	± 1.5%	± 1.0%	± 1.5%	± 1.0%	± 0.5%	± 0.5%

The work sizes of our **special pieces** are given according to visual sides.

6. Surface Quality, DIN EN ISO 10545-2

The surfaces of 1 m² or 30 pieces are tested at 300 lux for visible defects at a distance of 1 m.

7. Color Deviations, DIN EN ISO 10545-16

Glazed mono-colored products with values of Δ E_{cmc} < 0.75 are considered as identical in color; the value of 1.0 applies to unglazed mono-colored products.

7.1. Color Shade Grading

The color shade code is stamped on the box. Only identical color shades will result in a uniform surface look. In the case of rustic split tiles greater color deviations are normal. During laying, tiles from different boxes should be mixed.

8. Size Grading

The production sizes vary for technical reasons. The production size is coded and stamped on the box. Only boxes with the same coding should be laid together. According to VOB, the differences are evened out in the joints.

All references to as well as quotations from product and test standards are to be considered as information which is not binding. The latest versions apply.

Physical Properties

1. Water Absorption, DIN EN ISO 10545-3

The **water absorption (E)** gives the weight increase as compared to the dry weight of samples saturated with water under vacuum.

1.1 Apparent Density, DIN EN ISO 10545-3

It gives the ratio between mass and external volume.

2. Modulus of Rupture, DIN EN ISO 10545-4

The breaking strength **F** is determined on samples by means of the tree-point load in **N**. From this, the modulus of rupture and the breaking load are calculated according to the following formula.

Modulus of Rupture

$$R = \frac{3 \cdot F \cdot L}{2 \cdot b \cdot h^2}$$

F = breaking strength in N
L = bearing span in mm
b = width in mm
h = thickness in mm
R = modulus of rupture

Breaking Load

$$S = \frac{F \cdot L}{b}$$

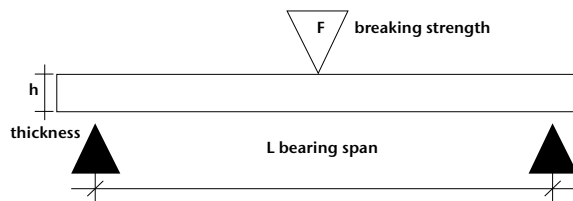

Possible Applications	Stress Group
Breaking strength under 1,500 N Housing construction and floor coverings subject to comparable mechanical stress, e.g. hotel bathrooms, rooms in the health service sector	1
Breaking strength 1,500 – 3,000 N Administration, trade and industry (practicable with vehicles with pneumatic tyres), e.g. canteen kitchens, canteens, traffic zones, car exhibition and maintenance areas, sales rooms, always without industrial truck traffic Floor pressures up to 2 N/mm ²	2
Breaking strength 3,000 – 5,000 N Trade and industry (industrial truck traffic with superelastic, solid rubber and vulkollan tyres), e.g. in food retailing and wholesaling, non-food retailing and wholesaling, shopping malls Floor pressures 2 to 6 N/mm ²	3
Breaking strength 5,000 – 8,000 N Trade and industry; areas of application as in group 3, but practicable with polyamide rollers Floor pressures 6 to 20 N/mm ²	4
Breaking strength above 8,000 N Trade and industry; heavy-duty areas with industrial truck traffic with polyamide rollers; runners of metal parts, such as e.g. in factory buildings, assembly halls and storerooms, repair workshops for machines and heavy equipment Floor pressures > 20 N/mm ²	5

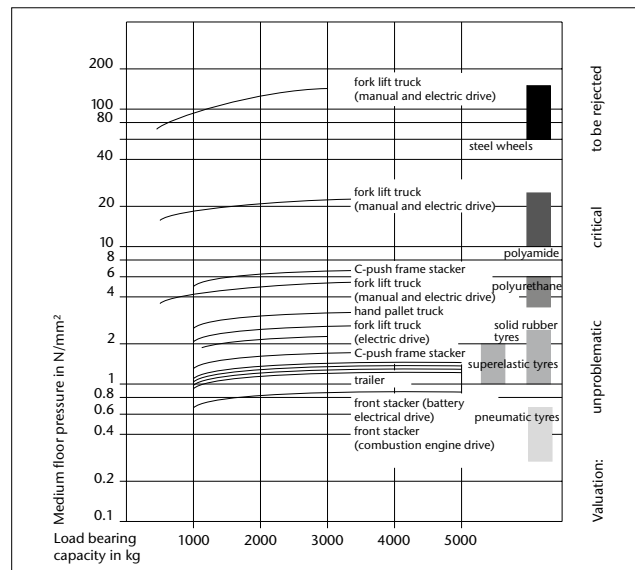

Floor pressures in N/mm² of industrial truck wheels according to a FMPA test in Stuttgart

The table illustrates the floor loads and indicates the effect of the different wheel types: steel wheels should be rejected and polyamide (Nylon and Perlon) is not advisable. Softer tyres (≤ 75 Shore-A-Hardness) as well as larger wheel diameters and wider supporting surfaces are especially advantageous.

Important note:

The “application possibilities” are of course only recommendations, as the method and quality of laying are decisive factors. Our recommendations are based on conventional, professional laying. With increasing mechanical load as well as harder tyres a thicker tile is required.

All references to as well as quotations from product and test standards are to be considered as information which is not binding. The latest versions apply.

Mechanical Strength

Deutsche Steinzeug offers tiles in thicknesses from 5 up to 20 mm for extreme loads in industrial and commercial areas. The breaking load values of our products partly are by far better than the values required by DIN EN 14411 (the relevant test certificates will be made available on request).

The calculated breaking load indicates the suitability for floors subject to mechanical loads. The stress itself is caused by bending rather than by pressure. The “extra strong” tiles from our programme with their high pressure, breaking and bending strength values are the ideal covering for floors subject to heavy loads. They withstand the wheels of industrial trucks, fork lift trucks and platform lift-trucks with their high floor pressure. They are especially suitable as floor coverings for industrial logistics, hyper- and supermarkets.

3. Compressive Strength

The compressive strength of tiles is not standardized. In the case of vitrified dry-pressed tiles it reaches values of up to 150 N/mm². The following conversion table shows the importance of a perfect and professional embedding of the tiles on site. The relatively low values for cement and thin-bed mortar can only be compensated by special and professional laying (mortar composition, water/cement value and manual or mechanical compression).

4. Resistance to Shock, DIN EN ISO 10545-5

Rebound measurement with 5 samples.

5. Resistance to Deep Abrasion, DIN EN ISO 10545-6

With regard to the deep abrasion on unglazed tiles, the abrasion is determined by means of fusion corundum and a rubbing plate. The lower the value, the higher the wear resistance of the material.

6. Glaze Abrasion, DIN EN ISO 10545-7

The abrasion class of glazed tiles is established in the wet test. Artificial abrasion is produced with the help of aluminium oxide grains, steel balls and the addition of water in an eccentrically revolving system. The number of revolutions at which a visible change of the test surface occurs results in the following classification:

Resistance to Surface Abrasion	
Class	Revolutions
0	100
1	150
2	600
3	750/1500
4	2100/6000/12000
5	>12000*

* Must pass the stain test according to DIN EN ISO 10545-14.

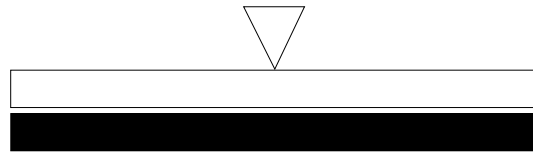

Vitrified material has a compressive strength approx. 10 - 20 times higher than cement mortar, cast plaster floors and reinforced concrete.

Conversion table for different materials

Types of material	N/mm ²	N/cm ²	kN/cm ²
Vitrified dry-pressed tiles	100 – 150	10,000 – 15,000	10 – 15
Extruded split tiles	180 – 250	18,000 – 25,000	18 – 25
Cement mortar Gr. III	10	1,000	1
High-grade cement mortar	20	2,000	2
Thin-bed mortar	15 – 30	1,500 – 3,000	1.5 – 3
Epoxy resins	60 – 75	6,000 – 7,500	6 – 7.5
Cement screed CT, C12 (ZE 12)	12	1,200	1.2
CT, C20 (ZE 20)	20	2,000	2
CT, C30 (ZE 30)	30	3,000	3
Mechanically resistant floor 65	65	6,500	6.5
Reinforced concrete C 20/25 (B 25)	25	2,500	2.5
C 30/37 (B 35)	35	3,500	3.5

Class 0

The use of glazed tiles of this class for floor coverings is not recommended.

Class 1

Floor coverings in areas mainly walked on in soft footwear or barefoot and not exposed to abrasive dirt (e.g. bathrooms and bedrooms without direct access from outside).

Class 2

Floor coverings in areas occasionally walked on with soft or normal footwear and exposed to only little abrasive dirt (e.g. rooms in living areas of houses, except kitchens, entrances and similar heavily frequented rooms). This does not apply to special footwear such as e.g. hobnailed boots.

Class 3

Floor coverings in areas frequently walked on with normal shoes and exposed to little abrasive dirt (e.g. kitchen-cum-living-rooms, halls, corridors, balconies, loggias and terraces). This does not apply to special footwear such as e.g. hobnailed boots.

Class 4

Floor coverings walked on regularly and exposed to little abrasive dirt, so that they are subject to greater stress as in the case of class 3 (e.g. commercial kitchens, hotels, exhibition and sales rooms).

Class 5

Floor coverings subject to heavy pedestrian traffic over long periods of time and exposed to little abrasive dirt, so that they are subject to the most extreme stress under which glazed tiles can be applicable (e.g. public areas such as shopping centres, entrance halls of airports, hotel foyers, public footpaths and industrial applications).

Every floor covering is subject to wear. This depends on the area of application and the frequency of use, the kind and degree of dirt as well as the hardness and resistance to wear of the covering material. While unglazed vitrified floor tiles can be used practically anywhere, glazed floor tiles have to be categorized according to stress groups. Scrapers, mats and the like help to remove dirt and abrasives and to protect glazed floor coverings. Something of this kind has to be provided especially in rooms with direct access from outside or from the garden.

Extreme Stress

For such areas we recommend the use of integrally colored, unglazed tiles, which are available in a wide range of colors and sizes. Examples: floors subject to high traffic loads, e.g. in supermarkets, hotels, schools, administrative buildings, railway stations, hospitals, passageways, etc., taking into account the mechanical load.

7. Coefficient of Expansion, DIN EN ISO 10545-8

The coefficient of expansion is ascertained between room temperature and 100°C ermittelt. The measured values are at around 6.0×10^{-6} m/(mK) in the case of vitrified materials and at around 8.0×10^{-6} m/(mK) in the case of porcelain stoneware. At 8 m length and 50° temperature difference the result is a change in length of approx. 2.4 mm in the case of vitrified materials (in the case of screed/concrete 4.6 mm and steel 5.6 mm).

8. Thermal Shock Resistance, DIN EN ISO 10545-9

The thermal shock resistance is tested between 15° and 145°C.

9. Moisture Expansion, DIN EN ISO 10545-10

The moisture expansion is determined between tempered and water-saturated samples.

10. Resistance to Glaze Cracking, DIN EN ISO 10545-11

This test takes place in the autoclave at 500 KPa with subsequent color control.

Glazes with hair cracks/crazes are marked as such and require the wetting of the covering prior to pointing to avoid deposits of fine particles of the pointing mortar in the hair cracks. Colored pointing compounds are not suitable in the case of these glazes. The glaze surfaces must not be marked with felt-tip pen and the like.

11. Thermal Conductivity etc.

Thermal conductivity, heat radiation and storage capacity as well as the thermal resistance are not standardized. Vitrified material produces the following approximate values:

Thermal conductivity:	1 W/mK	Heat storage capacity:	0.8 kJ/kgK
Heat radiation:	5.3 W/m ² K ⁴	Thermal resistance:	0.01 m ² K/W

12. Electrical Leakage Resistance

With a volume resistance of $>10^{10}$ Ohm (DIN EN 1081), our ceramics is insulating in dry condition. With the series Eladuct and KerAion ELA 10.6, however, we offer ceramics for floors capable of discharging static electricity. The glaze of ELA 10.6 has a surface resistance of approx. 10^6 Ohm according to DIN EN 1081. The discharge of static electricity is effected from the glaze via conductive joints and tile adhesive into copper strips to be connected to earth, which are laid on the base to be tiled. In the case of Eladuct, the complete tile body is capable of discharging static electricity. The volume resistance according to DIN EN 1081 is approx. 10^8 Ohm. Here, conductive joints are not required; apart from that, the base has to be carried out as described for ELA 10.6.

13. Steam Diffusion Resistance

According to DIN EN ISO 12572 the steam diffusion resistance is approx. μ 120,000 in the case of vitrified material/split tiles and μ 100,000 in the case of earthenware (excluding joints).

14. Resistance to Frost, DIN EN ISO 10545-12

The test for frost resistance is carried out on 10 samples or >0.25 m² samples. After water saturation under vacuum the samples are checked for defects after 100 frost-thaw alternations.

The resistance to frost of an outdoor flooring, however, does not only depend on the quality of the ceramic tiles used. **Professional construction and laying are essential.** For this, please refer to our specifications and the notice of the umbrella organization of the German building and construction industry "Outdoor Tiled and Paved Coverings".

15. Light and Color Fastness

Both glazed and unglazed ceramics are light- and color-fast according to DIN 51094.

16. Luminance

The lightness value of a tile describes the brightness of the surface as perceived by the human eye. The measuring value $Y = 100$ corresponds to the brightness of an absolutely white surface, and $Y = 0$ to that of an absolutely black surface.

The lightness value is determined for mono-colored tiles.

17. Behaviour in Fire

Ceramic tiles are classified A 1 according to EN ISO 13501-1 and DIN EN 14411. Therefore, they are generally non-combustible and thus fire-resistant. Also in the case of fire they do not release any toxic emissions.

Chemical Properties

1. Resistance to Chemicals, DIN EN ISO 10545-13

Resistance to Household Chemicals and Bath Water Additives

- Household chemicals
 - Ammonium chloride solution 100 g/l
- Bath salts
 - Sodium hypochlorite solution 20 mg/l

Classes

A/B/C*

Resistance to Acids and Alkalis

- Low concentration (L)
 - a) Hydrochloric acid solution 3% (V/V)
 - b) Citric acid solution 100 g/l
 - c) Potassium hydroxide solution 30 g/l
- High concentration (H)
 - a) Hydrochloric acid solution 18% (V/V)
 - b) Lactic acid solution 5% (V/V)
 - c) Potassium hydroxide solution 100 g/l

Classes

LA/LB/LC or HA/HB/HC*

Acid Protection and Apparatus Engineering

The resistance for acid protection engineering DIN EN 993-16 or chemical apparatus engineering DIN 28062 is subject to individual tests.

* Class A shows the highest resistance to chemicals, which decreases more and more towards C.

2. Stain Resistance, DIN EN ISO 10545-14

Stain Forming Substances

- Stain forming substances, leaving traces
 - Green stain forming substances in oil
 - Red stain forming substances in oil
- Chemical stain forming substances
 - Iodine, 13 g/l in alcohol
- Stain forming substances, forming a film
 - Olive oil

Cleaning (within the framework of the test)

- Cleaning agent
 - Hot water (+55 °C)
 - Weak cleaning agent
 - Strong cleaning agent
- Solvent
 - Hydrochloric acid solution 3% (V/V)
 - Potassium hydroxide 200 g/l
 - Acetone

Classes

Cl. 5 / Cl. 4 / Cl. 3 / Cl. 2 / Cl. 1*

3. Lead and Cadmium Delivery

The glazed surfaces are exposed to a 4 percent acetic acid solution. Then, the quantity of the delivered lead and cadmium is determined.

* Class 5 shows the highest stain resistance, which decreases more and more towards 1.

Surface Coatings and Upgradings

Hytect

Hytect is a highly effective and durable coating of tiles and panels of Deutsche Steinzeug.

The coating baked onto the surface on the base of titanium dioxide uses the principle of the photocatalysis.

It offers the user the following advantages:

A) Hytect decomposes bacteria and germs

The surface is activated by sunlight or artificial lighting. Activated oxygen forms, which decomposes microorganisms.

B) Hytect eliminates disagreeable odours

Disagreeable or even unhealthy odours in the air are also eliminated by Hytect.

C) Hytect reduces the cleaning efforts

The hydrophilic surface makes it possible for water to get under the dirt. In this way the quantity of cleaning agents is considerably reduced, which means a contribution to environmental protection and the saving of time for manual works at the same time.

Hytect surfaces are odourless, non-poisonous, meet the requirements for food and are completely harmless for persons suffering from allergies.

Laying and pointing are carried out by the usual techniques. The conventional agents (without hydrofluoric acid and its compounds) are applicable for cleaning. All additives forming a film, leaving fat on the surface or impregnating are excluded, which impair the surface activation by light.

Renowned institutes in Germany and abroad have confirmed us the corresponding effects of Hytect.

Protecta Surface Upgrading



Better Beats Good ...

Unglazed vitrified tiles are hard-wearing and resistant by nature. Thanks to the Protecta surface upgrading, the stain and dirt resistance could be improved considerably: during the firing process, the coating applied in-plant is ceramically bonded to the biscuit and closes the existing "micropores" quite natural for unglazed ceramics. In this way, the penetration of substances forming stains is prevented. Thus, an impregnation is no longer required and may possibly even have a negative effect in the case of slip-resistant tiles with Protecta surface upgrading, as the impregnating agent can not penetrate the tile but remains on the surface as lubricating film.

Products with Protecta surface upgrading are marked with this symbol in the corresponding series:



Hygiene

Glazed tiles and tiles with Protecta surface upgrading of Deutsche Steinzeug ensure the best possible hygiene conditions. Thanks to the closed surface, they offer no possibility for germs to proliferate. Tests of institutes for hygiene confirm the suitability for the covering of drinking water reservoirs. Hyper-sensitive people such as those suffering from allergies make the best experiences with tiles.

Cleaning

On principle, claddings and coverings must be protected by appropriate measures against heavy soiling which may be caused in particular by subsequent construction works (painting etc.).

Our tiles can generally be cleaned with water and a neutral or alkaline cleaning agent.

In the case of hard water, the sporadic use of acid cleaning agents is required. In the case of stains, cleaning depends on the type of stains and has to be carried out with suitable chemicals.

In the case of a higher concentration of the cleaning agent used, subsequent wiping with clear water is required. Rinsing with clear water is absolutely necessary when carrying out a basic cleaning. Cleaning agents containing maintenance additives are not recommended by us. They usually reduce the slip resistance and cause a negative visual appearance of the floor covering by forming layers! Important: the use of cleaning machines with pads containing abrasive grain has a polishing effect by which the slip resistance of the tiles is considerably reduced. We therefore expressly disapprove of such methods. Hydrofluoric acid or its compounds attack the ceramics and cause irreversible damage!

You will find detailed cleaning instructions for ceramic tiles on the Internet at www.agrob-buchtal.de

- ➔ Service
- ➔ Architects & Planners / Dealers / Tilers
- ➔ Cleaning instruction.

Impregnation

Unglazed stoneware without Protecta surface upgrading or Hytect coating should be impregnated in order to prevent the penetration of colored liquids, fats and oils and to facilitate cleaning.

The impregnating agent must be applied on the clean and dry floor; excess material must be removed immediately.

Slip Resistance

1. Coefficient of Friction/Slip Resistance

Workshop rules as well as accident prevention regulations require floors to be smooth, slip-resistant and easy to clean. Special protective measures against slipping are necessary where there is a risk as a result of the use of water, oil, slush, grease or waste. This should be taken into consideration when choosing the surface material. This clear requirement is based on investigations carried out by the insurance companies, which proved that slipping is the primary cause of accidents.

1.1. Industrial Areas

Competent authority:

Deutsche Gesetzliche Unfallversicherung,
Mittelstraße 51, 10117 Berlin-Mitte, phone: +49 (0)30 28876-3800,
fax: - 3808, www.dguv.de, info@dguv.de

Test standards: DIN EN 16165 and DIN 51133

Guideline: ASR A 1.5 - Floors

Code of practice: DGUV regulation 108-003 "Floors in work rooms and work areas with high risk of slipping" (previous BGR 181)

Test procedure: Inclined plane, safety footwear worn, test medium oil. The surface finish can be smooth, fine-rough, rough or profiled.

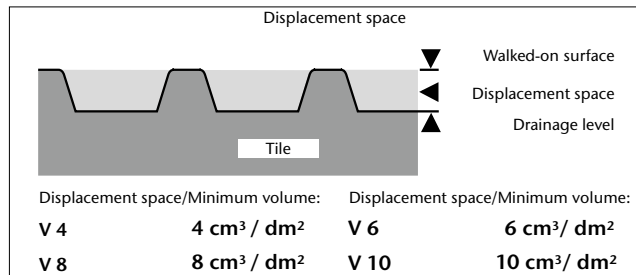

The displacement space (V4-V10) is the open space between the upper walked-on surface and the drainage level of profiled surfaces.

Valuation Groups

In a detailed table (see next page) the required valuation groups are assigned to work areas where there is a high risk of slipping. Information is available from Deutsche Gesetzliche Unfallversicherung and AGROB BUCHTAL.

Test on "inclined plane"

Valuation groups	Angle of inclination	Industrial + commercial areas
R9	> 6° - 10° low static friction	
R10	> 10° - 19° normal static friction	
R11	> 19° - 27° increased static friction	
R12	> 27° - 35° high static friction	
R13	> 35° very high static friction	

The indicated angles of inclination exclusively serve for the assignment of the valuation groups and can not be equated with the angles of inclination of slopes/ramps.

Slip-resistant tiles are marked with the logo "GRIP" in the corresponding series:



Legal Basis

Workshop rules as well as accident prevention regulations require floors to be smooth, slip-resistant and easy to clean.
The brochure "Technische Regel für Arbeitsstätten" ASR. A 1.5 – Floors (Code of practice for work areas) contains detailed requirements.

Publisher:

Bundesanstalt für Arbeitsschutz und Arbeitsmedizin (Ausschuss für Arbeitsstätten)
[Federal institute for safety at work and occupational medicine (Committee for work areas)]

Available at:

Download at www.baua.de

0 General work rooms and areas*

0.1	Entrance areas, indoors**)		R9
0.2	Entrance areas, outdoors	R11 (or R10 V4)	
0.3	Stairs, indoors***)		R9
0.4	Outdoor stairs	R11 (or R10 V4)	
0.5	Inclined ramps, indoor****) (from a slope of 3 %; e.g. for wheel chairs, compensation slopes, routes of transport)	One R-group higher than that required for the covering of the access area	V-Value of the covering of the access area, where applicable
0.6	Sanitary rooms		
0.6.1	Toilets		R9
0.6.2	Changing rooms and washrooms		R10
0.7	Break rooms (e.g. recreation room, company canteens)		R9
0.8	First aid rooms and comparable facilities (see ASR A4.3)		R9

1 Manufacture of margarine, edible fats and oils

1.1	Melting of fat		R13 V6
1.2	Cooking oil refinery		R13 V4
1.3	Margarine production and packaging		R12
1.4	Cooking fat production and packing, oil bottling		R12

2 Milk processing, cheese production

2.1	Fresh milk processing and butter production		R12
2.2	Cheese production, storage and packaging		R11
2.3	Icecream manufacturing		R12

3 Chocolate and confectionery production

3.1	Sugar processing		R12
3.2	Cocoa production		R12
3.3	Production of raw mixtures		R11
3.4	Fabrication of chocolate bars and shells and filled chocolates		R11

4 Production of bread, cakes and pastries

(bakeries, cake shops, production of long-life bakery products)			
4.1	Dough preparation		R11
4.2	Rooms in which predominantly fats or liquid mixtures are processed		R12
4.3	Washing-up rooms		R12 V4

5 Slaughtering, meat processing

5.1	Slaughter-house		R13 V10
5.2	Tripe processing room		R13 V10
5.3	Meat sectioning		R13 V8
5.4	Sausage kitchen		R13 V8
5.5	Boiled sausage unit		R13 V8
5.6	Raw sausage unit		R13 V6
5.7	Sausage drying room		R12
5.8	Gut store		R12
5.9	Salting and curing rooms, smoking establishments		R12
5.10	Poultry processing		R12 V6
5.11	Cold cuts and packaging unit		R12
5.12	Workshop with sales area		R12 V8 ****)

6 Fish processing, production of delicatessen

6.1	Fish processing		R13 V10
6.2	Production of delicatessen		R13 V6
6.3	Manufacture of mayonnaise		R13 V4

7 Processing of vegetables

7.1	Production of sauerkraut		R13 V6
7.2	Vegetable tinning		R13 V6
7.3	Sterilizing rooms		R11
7.4	Rooms in which vegetables are prepared for processing		R12 V4

8 Wet areas in food and beverage production

(if not specifically mentioned)			
8.1	Storage cellars		R10
8.2	Beverage bottling, fruit juice production		R11

9 Catering establishments

9.1	Kitchens in the catering trade (restaurant kitchens, hotel kitchens)		R12
9.2	Kitchens catering for homes, schools, day-care facilities for children, sanatoria		R11
9.3	Kitchens catering for hospitals, clinics		R12
9.4	Large kitchens catering for industrial and university canteens, and contract catering		R12
9.5	Food preparation kitchens (fast food kitchens, convenience restaurants and snack bars)		R12

9.6 Kitchens for heating up frozen meals R10

9.7 Coffee and tea kitchens, hotel garni kitchens and ward kitchens R10

9.8 Washing-up rooms R10

9.8.1 Washing-up rooms for 9.1, 9.4, 9.5 R12 V4

9.8.2 Washing-up rooms for 9.2 R11

9.8.3 Washing-up rooms for 9.3 R12

9.9 Dining rooms, guest rooms, canteens including serving counters R9

9.10 Counter area, bar area R10

10 Cold stores, deep freeze stores

10.1 for unpacked goods R12

10.2 for packed goods R11

11 Sales outlets, shops

11.1 Reception of goods, meat R11

11.1.1 for unpacked goods R11

11.1.2 for packed goods R10

11.2 Reception of goods, fish R11

11.3 Serving counters for meat and sausage R11

11.3.1 for unpacked goods (e.g. loose in transport boxes) R11

11.3.2 for packed goods R10

11.4 Serving counters for bread, cakes and pastries, unpacked goods R10

11.5 Serving counters for dairy products and delicatessen, unpacked goods R10

11.6 Serving counters for fish R10

11.6.1 for unpacked goods R12

11.6.2 for packed goods R11

11.7 Serving counters, except for nos. 11.3 to 11.6 R9

11.8 Meat preparation rooms R11

11.8.1 for meat preparation, except for no. 5 R12 V8

11.8.2 for meat processing, except for no. 5 R11

11.9 Florists shops R11

11.10 Sales areas with ovens R11

11.10.1 for the production of bread, cakes and pastries R11

11.10.2 for the warming up of prefabricated bread, cakes and pastries R10

11.11 Sales areas with chip pans or grills R12

11.12 Shops, customer rooms R9

11.13 Preparation areas for food for self-service shops (except for meat, fish and sausage) R10

11.14 Cash register areas, packing areas R9

11.15 Outdoor sales areas R11 (or R10 V4)

12 Health service rooms

12.1 Disinfection rooms (wet) R11

12.2 Pre-cleaning areas of sterilization R10

12.3 Faeces disposal rooms, discharge rooms, unclean nursing work rooms R10

12.4 Pathological facilities R10

12.5 Rooms for medical baths, hydrotherapy, fango preparation R11

12.6 Washrooms of operating theatres, plastering rooms R10

12.7 Sanitary rooms, ward bathrooms R10

12.8 Rooms for medical diagnosis and therapy, massage rooms R9

12.9 Operating theatres R9

12.10 Wards with hospital rooms and corridors R9

12.11 Medical practices, day clinics R9

12.12 Pharmacies R9

12.13 Laboratories R9

12.14 Hairdressing salons R9

13 Laundry

13.1 Rooms with continuous-flow washing machines or with spin-drier R9

13.2 Rooms with washing machines at which the clothes are taken out dripping wet R11

13.3 Ironing rooms R9

14 Fodder concentrate production

14.1 Dried fodder production R11

14.2 Fodder concentrate production using fat and water R11 V4

15 Leather production, textiles

15.1 Wet areas in tanneries R13

15.2 Rooms with fleshing machines R13 V10

15.3 Areas where leather scraps accumulate R13 V10

15.4 Rooms for making leather impermeable by means of grease R12

15.5 Dye mills for textiles R11

16 Paint shops

16.1 Wet grinding areas R12 V10

16.2 Powder coating R11

16.3 Painting R10

17 Ceramics industry

17.1 Wet grinding mills (processing of ceramic raw materials) R11

17.2 Mixers; handling of materials like tar, pitch, graphite and synthetic resins R11 V6

17.3 Presses (shaping); handling of materials like tar, pitch, graphite and synthetic resins R11 V6

17.4 Moulding, pressure die casting areas R12

17.5 Glazing areas R12

No responsibility is taken for the correctness of the information.
Validity at the time of printing, subject to changes in the meantime.

18 Glass and stone processing			
18.1 Stone cutting, stone grinding	R11	32.4 Pool surrounds	R10
18.2 Glass shaping of hollow glass ware, container ware	R11	<i>NOT recommended by AGROB BUCHTAL! Be sure to use R11 (in combination with valuation group B)!</i>	
18.3 Grinding areas for hollow glass ware, flat glass	R11		
18.4 Insulating glass manufacture; handling of drying agents	R11 V6		
18.5 Packaging, shipping of flat glass; handling of anti-adhesive agents	R11 V6		
18.6 Etching and acid polishing facilities for glass	R11		
19 Cast concrete factories			
19.1 Concrete washing areas	R11		
20 Storage areas			
20.1 Storage areas for oils and fats	R12 V6		
20.2 Storage areas for packed food	R10		
20.3 Outdoor storage areas	R11 (or R10 V4)		
21 Chemical and thermal treatment of iron and metal			
21.1 Pickling plants	R12		
21.2 Hardening shops	R12		
21.3 Laboratory rooms	R11		
22 Metal processing, metal workshops			
22.1 Galvanizing shops	R12		
22.2 Grey cast iron processing	R11 V4		
22.3 Mechanical processing areas (turnery, milling shop), punching room, pressroom, drawing shop (pipes, wires) and areas exposed to increased stress by oil and lubricants	R11 V4		
22.4 Parts cleaning areas, exhaust steam areas	R11 V4		
22.5 Partial cleaning areas, Damping areas	R12		
23 Vehicle repair workshops			
23.1 Repair and servicing bays	R11		
23.2 Working and inspection pits	R12 V4		
23.3 Car washing halls, washing areas	R11 V4		
24 Aircraft repair workshops			
24.1 Aircraft hangars	R11		
24.2 Repair hangars	R12		
24.3 Washing halls	R11 V4		
25 Sewage treatment plants			
25.1 Pump rooms	R12		
25.2 Rooms for sludge draining facilities	R12		
25.3 Rooms for screening equipment	R12		
25.4 Stands of workplaces, scaffolds and maintenance platforms	R12		
26 Fire brigade buildings			
26.1 Vehicle parking places	R12		
26.2 Rooms for hose maintenance equipment	R12		
27 Functional rooms in the respiratory protection training facility			
27.1 Preparation room	R10		
27.2 Fitness room	R10		
27.3 Training room	R11		
27.4 Sluice	R10		
27.5 Target room	R11		
27.6 Acclimatization room	R11		
27.7 Control room	R9		
28 Schools and day-care facilities for children			
28.1 Entrance areas, corridors, assembly halls	R9		
28.2 Class rooms, group rooms	R9		
28.3 Stairs	R9		
28.4 Toilets, washrooms	R10		
28.5 Instructional kitchens in schools (see no. 9.2, 9.6 or 9.7)	R10		
28.6 Kitchens in day-care facilities for children (also see no. 9)	R10		
28.7 Machine rooms for wood processing	R10		
28.8 Special rooms for handicrafts	R10		
28.9 Schoolyards	R11 (or R10 V4)		
29 Financial institutions			
29.1 Counter areas	R9		
30 Plant traffic routes in outdoor areas			
30.1 Footpaths	R11 (or R10 V4)		
30.2 Loading platforms			
30.2.1 covered	R11 (or R10 V4)		
30.2.2 uncovered	R12 (or R11 V4)		
30.3 Sloping ramps (from a slope of 3 %; e.g. for wheel-chairs, loading platforms)	R12 (or R11 V4)		
30.4 Tank-up areas			
30.4.1 covered	R11		
30.4.2 uncovered	R12		
31 Parking areas			
31.1 Garages, car-parks not exposed to weather influences*****)	R10		
31.2 Garages, car-parks exposed to weather influences	R11 (or R10 V4)		
31.3 Open-air parking areas	R11 (or R10 V4)		
32 Swimming pools			
32.1 Individual and common dressing rooms	R10		
32.2 Sauna and relaxation areas	R10		
32.3 Showers	R10		
<i>NOT recommended by AGROB BUCHTAL! Be sure to use R11 (in combination with valuation group B)!</i>			

*) For floors in wet areas walked on barefoot, see DGUV information "Floor coverings in wet barefoot areas" (DGUV information 207-006).

**) Entrance areas according to number 0.1 are all areas with direct access from outside and in which moisture from outside can be brought (also see section 6 para. 3, utilization of products absorbing dirt and moisture). For adjoining areas or other rooms with large surfaces, section 4 para. 10 has to be observed.

***) Stairs and ramps according to numbers 0.3 and 0.5 are those possibly exposed to moisture brought in from outside. For adjoining areas, section 4 para. 10 has to be observed.

****) If the same floor covering was laid in all areas, the displacement space can be lowered down to V4 after a risk assessment (taking into consideration the cleaning method, the working processes and the quantity of slippery substances on the floor).

*****) The pedestrian areas which are not subject to a risk of slipping because of weather influences such as driving rain or moisture brought in.

Floors in rooms must not present any irregularities, cavities or dangerous slopes; stumbling must be impossible on these floors. They must be secured against shifting or tilting (e.g. in the case of covers), load-bearing and slip-resistant.

Floors are to be designed without inclination. Exception: functional inclinations outside of permanently installed workplaces, e.g. for the drainage of liquids or for bridging differences in height, e.g. with walkable sloping ramps.

In areas which must be continuously frequented in the scope of their normal utilization, the slip resistances of the different floor surfaces must not differ from each other to such an extent that there may be a risk of stumbling and slipping.

This may be the case if adjoining floor surfaces differ with regard to slip resistance: 1. by more than one R-group in the case of two adjoining areas.

2. by more than two R-groups if the transition to a different slip resistance is clearly visible or is to be expected (e.g. in the case of door passages).

If there is a risk of stumbling or slipping due to different slip resistances, appropriate measures have to be taken, such as transition zones which are at least 1.5 m long in the direction of walking.

Note: It is recommended to design the slip resistance of a floor within a working area as uniformly as possible, e.g. by making sure that other surface qualities within the floor covering, such as covers, markings or films glued on the floor, do not differ from each other by more than one R-group.

Entrances of buildings have to be designed in such a way that dirt and moisture brought in do not cause a risk of slipping. A sufficiently large roofing above entrances of buildings is an appropriate measure for this.

Inside the building, this can be achieved by providing clean-off zones in the form of mats absorbing the dirt and the moisture, which are specially designed for the expected pedestrian traffic with regard to their length, width and the material used and are at least 1.5 m long in the direction of walking over the whole width of the passage.

Clean-off zones must be secured against shifting and must not cause a risk of slipping, e.g. by being flush with the directly adjoining floor covering. Depending on the degree of soiling, clean-off zones must be cleaned or replaced in such a way that their functionality is maintained.

Depending on the operational exposure to slippery substances to be expected, floors in working rooms and areas must be provided with a discharge facility, if required.

The surfaces adjoining discharge openings as well as drain channels should have a slope of at least 2 per cent in order to facilitate the draining of fluid liquids. These areas should preferably be located outside of traffic routes. The discharge of liquids via traffic routes should be avoided, if possible.

Floor surfaces which normally are wet and have to be walked on barefoot, e.g. in swimming pools as well as sanitary rooms such as washing and changing rooms, must be suitable for ensuring safe walking.

1.2. Barefoot areas

Competent authority:

Deutsche Gesetzliche Unfallversicherung, Mittelstraße 51, 10117 Berlin-Mitte, tel.: +49 (0)30 28876-3800, fax: - 3808, www.dguv.de, info@dguv.de, www.unfallkassen.de.

Floors in wet barefoot areas, e. g. swimming pools, hospitals as well as dressing rooms, washrooms and showers in sports and work facilities.

Test standard: DIN EN 16165.

Code of practice: DGUV information 207-006 "Floor coverings in wet barefoot areas" (previous GUV-I 8527).

Testing method: Inclined plane, walked on barefoot, wetting agent solution as test medium.

The surfaces are smooth, micro-rough or slightly profiled. "Nonslip" glazes with their micro-rough surfaces have proved to be excellent in practice.

The various areas are assigned to the valuation groups. Information can be obtained from Deutsche Gesetzliche Unfallversicherung and AGROB BUCHTAL.

Valuation group A

- Barefoot passages and sanitary areas (nearly dry)
- Individual and common dressing rooms
- Pool floors in non-swimmer areas if the water depth is more than 80 cm in the entire area
- Sauna and relaxation areas (nearly dry)

Valuation group B



- Barefoot passages and sanitary areas, if not classified in group A
- Showers
- Steam baths
- Area of disinfecting spray facilities
- Pool surrounds
- Pool floors in non-swimmer areas if the water depth is less than 80 cm in certain areas
- Non-swimmer sections of wave-action pools
- Movable floors
- Paddling pools
- Ladders and stairs outside the pool area, if not classified in group C
- Accessible surfaces of diving platforms and diving boards, if not classified in group C
- Sauna and relaxation areas, if not classified in group A

Valuation group C

- Ladders and stairs leading into the water
- Stairs up to diving facilities and water slides
- Surfaces of diving platforms and diving boards over the length reserved for the diver (the slip-resistant surface of the diving platforms and diving boards must cover the front edge where the hands and the toes of the divers grip)
- Walk-through pools
- Inclined pool edge designs
- Kneipp basins, water-treading basins
- Ramps in the pool surround area with an inclination > 6 %
- Starting blocks

Walkable seating areas such as e.g. stands and pedestals near the pool into which moisture can be brought must be treated like floor coverings. If barefoot areas are regularly also walked on with footwear, the requirements according to ASR A1.5/1,2 must be observed in addition.

Test on "inclined plane"

Valuation groups	Angle of inclination	Barefoot area
A	$\geq 12^\circ$	
B	$\geq 18^\circ$	
C	$\geq 24^\circ$	

The indicated angles of inclination exclusively serve for the assignment of the valuation groups and can not be equated with the angles of inclination of slopes/ramps.

1.3. Measurement of sliding friction

Competent authority:

Deutsche Gesetzliche Unfallversicherung, Mittelstraße 51, 10117 Berlin-Mitte, tel.: +49 (0)30 28876-3800, fax: - 3808, www.dguv.de, info@dguv.de, www.unfallkassen.de.

Test standard: DIN 51131

Code of practice: DGUV information 208-041 "Assessment of the risk of slipping under operating conditions" (previous GUV-I 8687).

This test is not a type examination and thus is neither suitable for the choice of floor coverings at the planning stage nor for classification in a slip-resistance valuation group. The method can be applied, e.g. for assessing the success of cleaning measures or in the event of planned changes of utilisation.

For the choice of a floor covering, DGUV information 108-003 (previous BGR 181) and DGUV information 207-006 (previous GUV-I 8527) respectively must be applied exclusively!

1.4. Private areas

With regard to slip resistance, ceramic floor coverings in private areas are not subject to standard regulations. Independent of that, however, we recommend that you choose slip-resistant tiles according to your personal safety requirements.

Color Shade Variation

“Color shade variation” refers to the variations in color between the tiles of a certain color, i.e. the degree of shading. Our products are classified into 4 shading coefficients.

V0 = No variation / no play of colors
V1 = Low variation / low play of colors
V2 = Medium variation / medium play of colors
V3 = High variation / high play of colors
V4 = Strong variation / strong play of colors

Mosaics glued thermoplastically on back: Permanently safe also in wet areas

The thermoplastic glueing of mosaics of the brands AGROB BUCHTAL and Jasba is also perfectly suitable for permanently wet and underwater areas. Analyses of independent institutes have proved that no microbiological infestation at the glass fibre net occurs under normal hygienic conditions. With the values $>0.5\text{N/mm}^2$, the bonding behaviour after dry and wet storage is better than the values required according to DIN EN 12004. Thus, the thermoplastic glueing on back can be recommended not only for dry areas but also for underwater areas (swimming

pools and whirlpools) as well as for permanently wet areas such as showers and pool surrounds. In addition, the glueing on back facilitates laying and leads to considerable time saving compared to the film on the face side required so far. The glass fibre net on the back largely prevents the penetration of tile adhesive in the joints. The time-consuming removal of the film and possible residues on the tile surface is no longer necessary, and the cladding of columns and curvatures is significantly simplified.

List of Addresses

Bundesanstalt für Arbeitsschutz und Arbeitsmedizin (BAuA)
 (Federal institute for safety at work and occupational medicine)
 Friedrich-Henkel-Weg 1-25, 44149 Dortmund
 Telephone: +49-231-9071-0, Fax: -2454,
 www.baua.de, poststelle@baua.bund.de

DGUV Rules and Regulations (BG/GUV)
Deutsche Gesetzliche Unfallversicherung
 Mittelstraße 51, 10117 Berlin-Mitte,
 Telephone: +49-30-28876-3800, Fax: -3808,
 www.dguv.de, info@dguv.de

DIN/EN/ISO Standards Sheets
 Deutsches Institut für Normung e. V., 10772 Berlin
 Telephone: +49-30-2601-0, Fax: -60,
 www.din.de, info@din.de,
 Available from:
 Beuth Verlag GmbH, Burggrafenstraße 6,
 10787 Berlin, Telefon: +49-30-2601-2201-0, Fax: -1260,
 www.beuth.de, info@beuth.de

KOK-Directives for Swimming Pool Construction
RK-List of Tested Cleaning Agents
DGfdB Rules and Regulations
 Deutsche Gesellschaft für das Badewesen e. V.,
 45130 Essen
 Telephone: +49-201-87969-0, Fax: -20,
 www.baederportal.com, info@baederportal.com
 Directly available from the publisher

Bundesverband Keramische Fliesen e. V.
 Luisenstraße 44, 10177 Berlin
 Telephone: 030/27 59 59 74-0, Fax: -99
 www.fliesenverband.de, info@fliesenverband.de

ZDB Notices
Professional Association for Tiles and Natural Stone in the
Central Association of the German Construction Industry
 Kronenstr. 55-58, 10117 Berlin-Mitte,
 Telephone: +49-30-20314-0, Fax: -419,
 www.fachverbandfliesen.de, info@fachverband-fliesen.de
 Available from:
 Verlagsgesellschaft Rudolf Müller GmbH & CoKG,
 Stolberger Straße 84, 50933 Köln
 Postfach: 410949, 50869 Köln
 Telephone: +49-221-5497-112, Fax: -6112
 www.baufachmedien.de, service@rudolf-mueller.de

Quality Controls
 Quality controls are carried out by:
 – manufacturers themselves with strict sorting
 – controls and special tests by the Deutsche Steinzeug laboratories
 – individual and batch testing by external material
 testing institutions in Germany and abroad

Certificates

The characteristics and the quality of our products are constantly tested by acknowledged material testing institutions. The corresponding test certificates are available.



* We will be pleased to make a survey of the certified individual products available to you on request.

Shower Tub System – Area Pro/Plural non-slip/Plural unglazed/Basis 3

The shower tub system consists of special tiles for realizing a shower tub integrated in the tile covering.

The shower tub system is a registered design. It meets the requirements of DIN 18040 “Barrier-free building” and DIN 18025 “Barrier-free living”.

In Germany, the 10 mm lip means that it is possible to take full advantage of various housing grants.

The 100 mm modular dimension inclusive of a 3 mm wide joint guarantees perfectly hygienic tile coverings with a narrow joint width and accurately sized tiles.

As with all slip-resistant surfaces of Plural non-slip/Plural unglazed, the series Basis 3, the surfaces of both the glazed and the ceramically upgraded unglazed tiles are very easy to clean.

The shower tub system is predestined for wet areas in hospitals, sanatoriums, rehabilitation centres, old people’s and nursing homes, but also for showers in commercial areas, swimming pool, sauna and sports facilities, hotel and private bathrooms.

1. The shower tub is a module with the necessary slope that can be integrated in the joint grid of the tile covering as required.

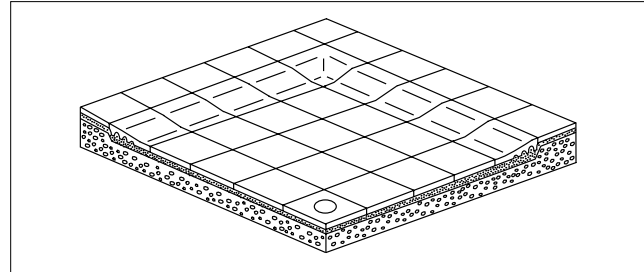

2. In combination with the cove skirting laid horizontally, a rounded transition between floor and wall covering is possible.

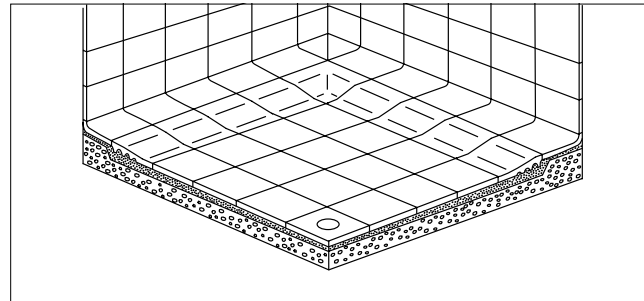

Area Pro, Plural non-slip, Plural unglazed

Basis 3 Softcorn

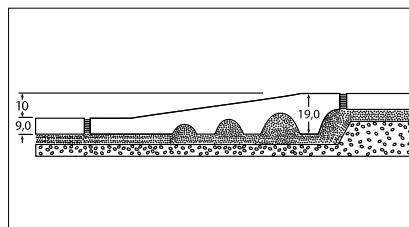
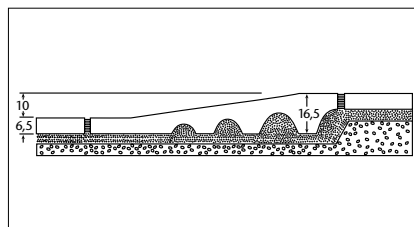
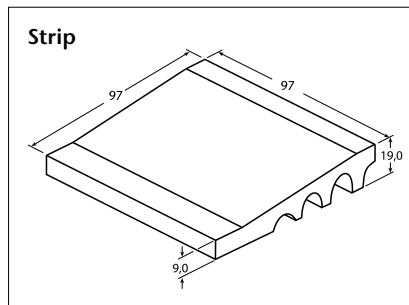
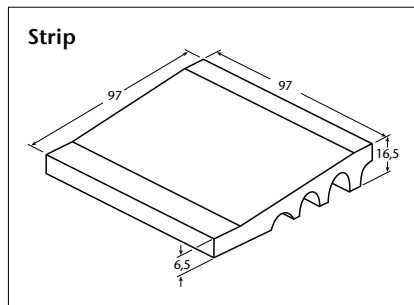
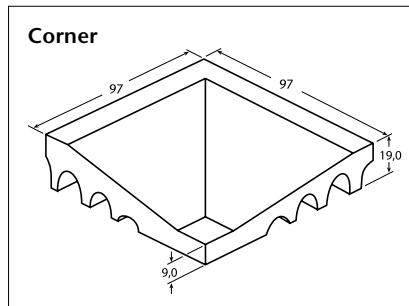
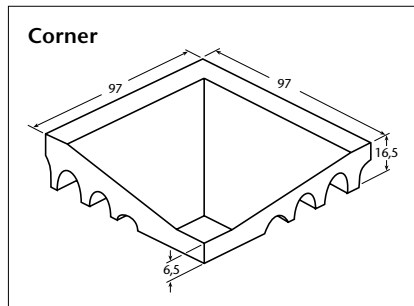

All references to as well as quotations from product and test standards are to be considered as information which is not binding. The latest versions apply.

The Shower Tub System of the Series Chroma / Chroma unglazed – Quantum

This shower tub system consists of only two components: the strip and the one-piece corner belonging to it.

A peculiarity of the system is the special form of the slope which provides a difference in height of 10 mm. The edge of the shower tub designed in this manner is easy to pass on foot and with a wheel-chair. The relevant requirements (DIN 18040 or 18025) with regard to barrier-free construction taking into account the needs of senior and handicapped persons are effectively supported in this way.

Thanks to the “integrated slope” the time-consuming execution of the edge of the shower tub on site is no longer required, and together with the even lower side facilitating laying the processing of these tiles is absolutely simple:

The shower tub system is perfectly completed by the series Chroma / Chroma unglazed – Quantum.

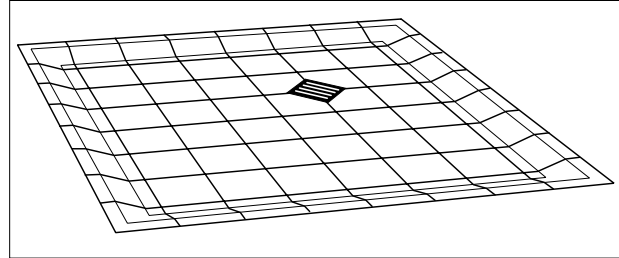

The shower tub system is based on a grid size of 12.5 x 12.5 cm. This permits a very variable dimensioning of the shower tub independent of standard dimensions and a harmonious integration in the shower installation or sanitary block.

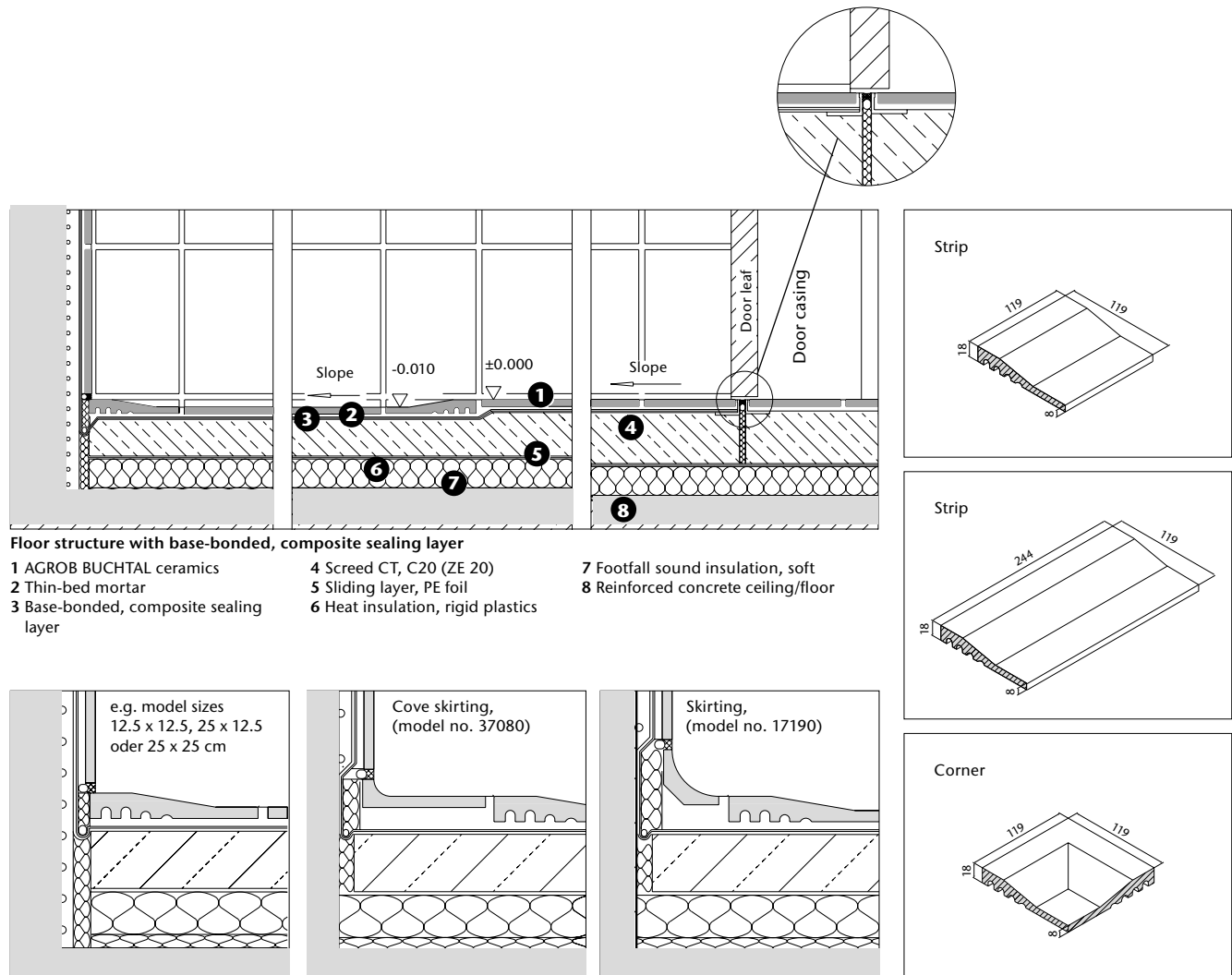

Wall connection variants

The shower tub systems of AGROB BUCHTAL are laid on a continuous screed and therefore do not require a high-maintenance movement joint between shower tub and adjoining areas.

All references to as well as quotations from product and test standards are to be considered as information which is not binding. The latest versions apply.

Cove Skirting

Cove Skirting 10 x 10 cm

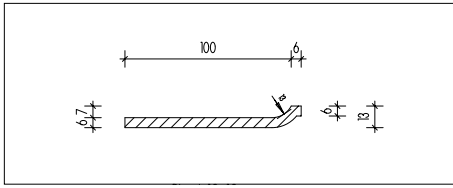

Fitting to:

Area Pro, smooth, 10 x 10 cm, unglazed
Plural/Plural non-slip, smooth and slip-resistant, 10 x 10 cm
Basis 2, smooth, 10 x 10 cm, glazed
Basis 3, smooth, 10 x 10 cm, unglazed
Plural unglazed, smooth, 10 x 10 cm

Cove Skirting 10 x 15, 10 x 20, 10 x 30 and 10 x 60 cm

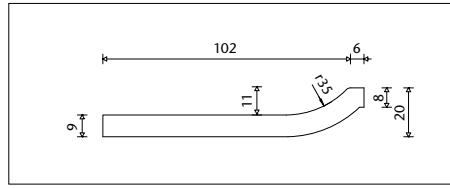

Fitting to:

Emotion GRIP, smooth or Softcorn, 10 x 20, 10 x 30 cm, unglazed
Basis 3, smooth, 10 x 15, 10 x 20 cm, unglazed
Basis Pro, smooth, 10 x 30 cm, unglazed
Area Pro, smooth, 10 x 20, 10 x 30 und 10 x 60 cm, unglazed

Cove Skirting 10 x 25, 10 x 50 and 10 x 60 cm

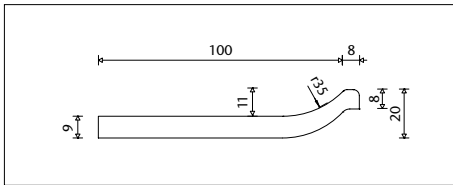

Fitting to:

Ascona, structured 10 x 25, 10 x 50, 10 x 60 cm glazed
Nova, smooth 10 x 60 cm glazed
Quarzit, structured 10 x 60 cm glazed

Cove Skirting 12.5 x 25 cm

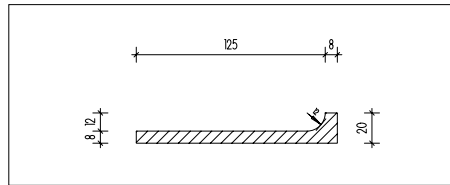

Fitting to:

Chroma unglazed, smooth, 12.5 x 25 cm, unglazed

Cove Skirting 12.5 x 25 cm

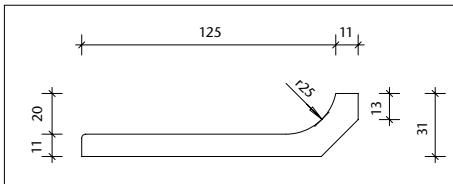

Fitting to:

Ferrum, smooth, 12.5 x 25 cm, unglazed

Internal Corner

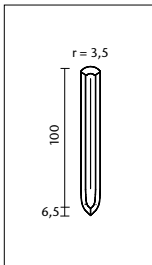

Fitting to
cove skirting:

Plural non-slip,
10 x 10 cm, glazed

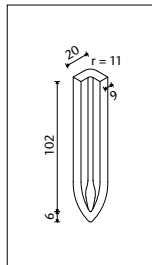

Fitting to
cove skirting:

Area Pro,
10 x 10, 10 x 20, 10 x 30,
10 x 60 cm, unglazed

Emotion GRIP,
10 x 20 and 10 x 30 cm,
unglazed

Basis 3,
10 x 20 cm, unglazed

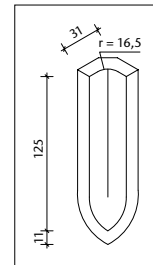

Fitting to
cove skirting:

Ferrum,
25 x 12.5 cm,
unglazed

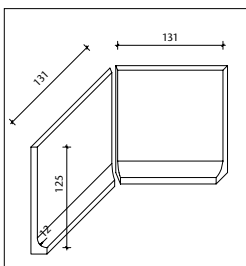

Fitting to
cove skirting:

Chroma unglazed,
12.5 x 25 cm, unglazed

Stair safety borders / stair tiles

Stair safety border
40 x 597 mm
with 3 grooves

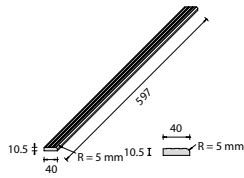

Stair safety border
72 x 597 mm
with 5 grooves

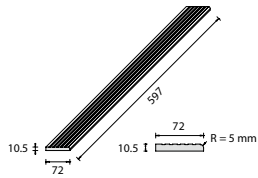

Stair safety border with bevel
72 x 1447 mm
with 5 grooves

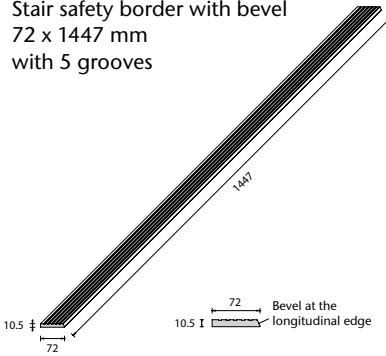

Stair safety border
72 x 1197 mm
with 5 grooves

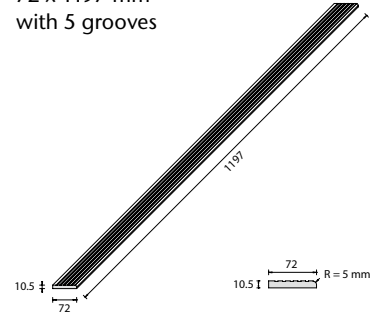

Stair tile
597 x 1197 mm with 5 grooves

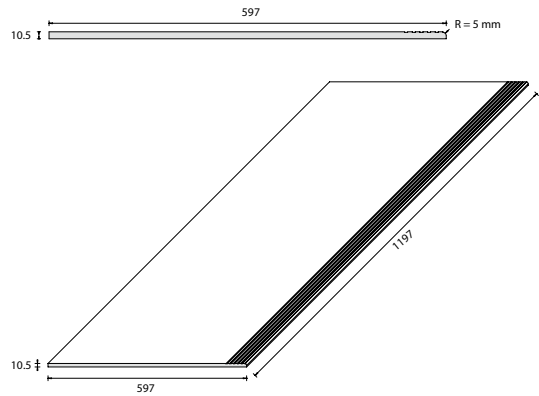

Stair tile with bevel
307 x 1447 mm with 5 grooves

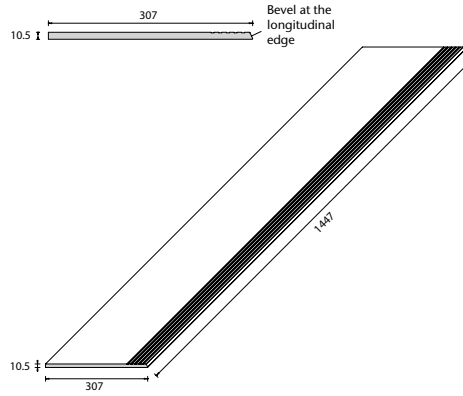

Patio tile with corner-adjacent rounded edges

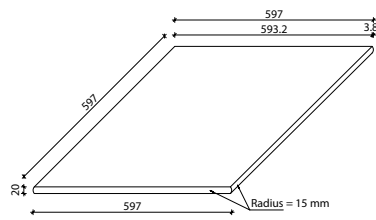

Patio tile with rounded edge on one side

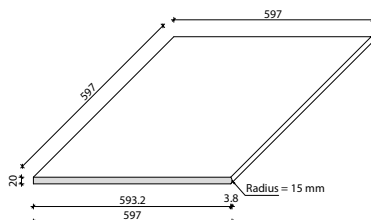

Patio tile step with nosing as corner solution

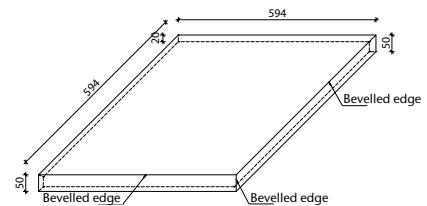

Patio tile with rounded edge on one side and grooves

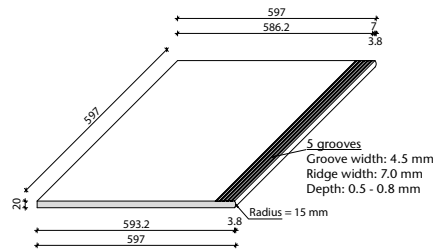

Patio tile with rounded edge on one side and grooves as corner solution (2 pieces)

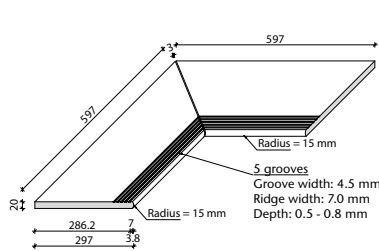

Patio tile step with nosing

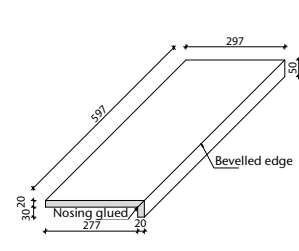

1. Construction Products Regulation (CPR)

The CPR distinguishes itself from the previous Construction Products Directive (CPD) above all by the Declaration of Performance, CE marking as well as assessment and verification of the constancy of performance of the product concerned.

Construction products brought into circulation after 1 July 2013 must comply with the CPR. "Bringing into circulation" means that a construction product is made available on the European market for the first time by the manufacturer. We would like to point out that the term of "provision" is delineated from that; it means the passing on of a construction product brought into circulation in the supply chain, e.g. from the specialist tile trade to end consumers.

Essential characteristics of a construction product – here ceramic tiles – are defined in Annex ZA of the harmonised standard DIN EN 14411.

2. CE marking

With the CE marking, the manufacturer indicates that it assumes responsibility for the conformity of the construction product with the performance stated in the Declaration of Performance as well as compliance with all relevant European legal regulations.

Furthermore, it is responsible for making sure that the CE marking is applied to the actual construction product, to a label or on the packaging. The CE marking is the sole conformity identification for all essential characteristics of a construction product. Additional marks may only be used for aspects which – in our case – are not regulated by DIN EN 14411.

3. Declaration of Performance

As of 1 July 2013, every manufacturer is obliged to establish a Declaration of Performance for each of its construction products. It thereby assumes responsibility for the conformity of the construction product with the declared performance. The Declaration of Performance replaces the former Declaration of Conformity.

The technical documentation of the manufacturer serves as basis for the Declaration of Performance. Among other things, it includes the results of the in-plant production controls such as e.g. initial tests.

The Declaration of Performance has to be provided with an arbitrary reference number by the manufacturer to which the CE marking refers, thus permitting unambiguous identification of the construction product.

The Declaration of Performance can be made available in printed or electronic form (e.g. by e-mail, CD or USB stick).

In addition, the Declarations of Performance for the construction products of AGROB BUCHTAL GmbH are to be found at www.agrob-buchtal.de/leistungserklaerung. Alternatively, you can scan this QR code:



Albania

POWATEC-AL sh.p.k.
Tel.: +355 4 2270731
Mobile: +355 69 2033095
E-mail: powatec@albmail.com

Australia

Ceramic Solutions (Aust) Pty Ltd.
Tel.: +61 3 95 45 53 22
E-mail: mail@ceramicsolutions.com.au
Internet: www.ceramicsolutions.com.au

Austria

Dipl. Ing. Silvia Lederer
Mobile: +43 664 30 76 68 6
E-mail: silvia.lederer@deutsche-steinzeug.de

Erwin Bauer

Mobile: +43 664 115 3558
E-mail: erwin.bauer@deutsche-steinzeug.de

Bahrain

Patric Kakoschky
Tel.: +49 94 35 3 91-34 47
Mobile: +49 160 7417906
E-mail: patric.kakoschky@deutsche-steinzeug.de

Baltic States

Nedas Bobinas
Tel.: +370 65 624217
E-mail: buchtal.baltic@gmail.com

Belgium

Johan Vanrompay
Mobile: +32 471 84 44 18
E-mail: johan.vanrompay@deutsche-steinzeug.de

Bosnia-Herzegovina

Lokar Zastopstva d.o.o.
Tel.: +386 15 61 21 63
E-mail: lokar.zastopstva-ds@siol.net

Bulgaria

Hristo Shterev
Mobile: +359 886 899 589
E-mail: hsterev@gmail.com

Canada

Eastern Canada
CERAGRES TILE GROUP INC.
E-mail: j.racine@ceragres.ca

Western Canada

V.P. Tile Imports
Tel.: +1 604 240 1760
E-mail: peter@vptile.ca

China

Jeffrey Lung - AGROB BUCHTAL GmbH
Shanghai Office
Tel.: +86 021 63 81 09 86
E-mail: jeffrey.lung@dsk-asia.com

Jeffrey Lung - AGROB BUCHTAL GmbH

Beijing Office
Tel.: +86 010 58 69 19 01
E-mail: jeffrey.lung@dsk-asia.com

Croatia

Lokar Zastopstva d.o.o.
Tel.: +386 15 61 21 63
E-mail: lokar.zastopstva-ds@siol.net

Cyprus

E.K.A. Ltd.
Tel.: +357 2 5 85 44 44
E-mail: mloizides@ekagroup.com

Czech Republic

Ceram Objekt s.r.o.
www.ceramobjekt.cz
Tel.: +420 2 71 74 17 414
E-mail: gciprianova@ceramobjekt.cz

Denmark

Torben Christensen
Tel.: +45 242 05 14 8
E-mail: buchtal@buchtal.dk

Egypt

Patric Kakoschky
Tel.: +49 94 35/3 91-34 47
Mobile: +49 160 7417906
E-mail: patric.kakoschky@deutsche-steinzeug.de

Finland

ABL Finland OY
Tel.: +358 9 3 50 87 00
E-mail: abl@abl.fi

France

Christophe Rodriguez
Deutsche Steinzeug France S.A.R.L.
Mobile: +33 6 40 94 34 32
E-mail: buchtal@buchtal.fr
Internet: www.agrob-buchtal.de

Great Britain

Rolf Klebl
Mobile: +49 160 74 28 839
E-mail: rolf.klebl@deutsche-steinzeug.de

Greece

Emco S.A.
Tel.: +30 210 6 13 83 10
E-mail: jbog@emco.gr

Hungary

Roland Fekete
Tel.: +36 96 51 70 17
E-mail: feket.roland@buchtal.hu

Iceland

Birgisson ehf
Tel.: +354 5160602
E-mail: egill@birgisson.is
Internet: www.birgisson.is

India

Patric Kakoschky
Tel.: +49 94 35 3 91-34 47
Mobile: +49 160 7417906
E-mail: patric.kakoschky@deutsche-steinzeug.de

Italy

Luigi Maresca
Tel.: +49 94 35 3 91-34 51
E-mail: luigi.maresca@deutsche-steinzeug.de

Japan

Rolf Klebl
Tel.: +49 94 35 3 91-33 26
Mobile: +49 160 742 88 39
E-mail: rolf.klebl@deutsche-steinzeug.de

Kosovo

Lokar Zastopstva d.o.o.
Tel.: +386 15 61 21 63
E-mail: lokar.zastopstva-ds@siol.net

Kuwait

Patric Kakoschky
Tel.: +49 94 35 3 91-34 47
Mobile: +49 160 7417906
E-mail: patric.kakoschky@deutsche-steinzeug.de

Lebanon

Patric Kakoschky
Tel.: +49 94 35 3 91-34 47
Mobile: +49 160 7417906
E-mail: patric.kakoschky@deutsche-steinzeug.de

Luxembourg

Philip Daelemans
Mobile: +32 495 30 33 03
E-mail: philip.daelemans@buchtal.be

Macedonia

Lokar Zastopstva d.o.o.
Tel.: +386 15 61 21 63
E-mail: lokar.zastopstva-ds@siol.net

Moldavia

Sabin Maghiar
Tel.: +40 743 45 29 58
E-mail: sabin.maghiar@deutsche-steinzeug.ro

Montenegro

Lokar Zastopstva d.o.o.
Tel.: +386 15 61 21 63
E-mail: lokar.zastopstva-ds@siol.net

Namibia

O. Behrens & Co. (PTY) Ltd., Windh.
Tel.: +264 61 23 83 00
E-mail: perstling@obeco.com.na

The Netherlands

Luuk Bovens
Mobile: +31 623 838399
E-mail: luuk.bovens@deutsche-steinzeug.de

Norway

Stein M. Skogstad
Tel.: +47 66 77 94 98
Mobile: +47 91 39 52 08
E-mail: stein@agrob-buchtal.no

Poland

Rafal Butkiewicz
Tel.: +48 6 01 70 67 57
E-mail: biuro@agrob-buchtal.pl

Portugal

Lusomatec
Tel.: +351 915828266
E-mail: nuno.conceicao@lusomatec.pt
Internet: www.lusomatec.pt

Qatar

Patric Kakoschky
Tel.: +49 94 35 3 91-34 47
Mobile: +49 160 7417906
E-mail: patric.kakoschky@deutsche-steinzeug.de

Romania

Sabin Maghiar
Tel.: +40 743 45 29 58
E-mail: sabin.maghiar@deutsche-steinzeug.ro

Saudi Arabia

Patric Kakoschky
Tel.: +49 94 35 3 91-34 47
Mobile: +49 160 7417906
E-mail: patric.kakoschky@deutsche-steinzeug.de

Serbia

Lokar Zastopstva d.o.o.
Tel.: +386 15 61 21 63
E-mail: lokar.zastopstva-ds@siol.net

Slovakia

BUCHTAL SK, s.r.o.
Tel.: +421 2 44 25 03 69
E-mail: b.hauswald@agrob-buchtal.sk
Internet: www.agrob-buchtal.sk

Slovenia

Lokar Zastopstva d.o.o.
Tel.: +386 15 61 21 63
E-mail: lokar.zastopstva-ds@siol.net

South Africa (RSA)

Patric Kakoschky
Tel.: +49 94 35 3 91-34 47
Mobile: +49 160 7417906
E-mail: patric.kakoschky@deutsche-steinzeug.de

Spain

Joaquin Prat Pérez-Nievas
Mobile: +34 607 923 470
E-mail: joaquin.prat@buchtal.es
Internet: www.buchtal.es

Sweden

Stein M. Skogstad
Tel.: +47 66 77 94 98
Mobile: +47 91 39 52 08
E-mail: stein@agrob-buchtal.no

Switzerland

Deutsche Steinzeug Schweiz AG
Tel.: +41 41 6 32 50 60
E-mail: info@deutsche-steinzeug.ch

Turkey

Patric Kakoschky
Tel.: +49 94 35 3 91-34 47
Mobile: +49 160 7417906
E-mail: patric.kakoschky@deutsche-steinzeug.de

UAE

Patric Kakoschky
Tel.: +49 94 35 3 91-34 47
Mobile: +49 160 7417906
E-mail: patric.kakoschky@deutsche-steinzeug.de

Ukraine

Andriy Horak
Tel.: +49 94 35 3 91-32 76
Mobile: +49 160 741 26 17
Fax: +49 94 35 3 91-30 32 76
E-mail: a.horak@deutsche-steinzeug.de

Sales management**Austria**

Robert Wölfler
Tel.: +43 664 1342659
E-mail: robert.woelfler@deutsche-steinzeug.de

Belgium, The Netherlands, Luxembourg

Richard van der Maaten
Mobile: +31 (0)621 478134
E-mail: richard.van-der-maaten@deutsche-steinzeug.de

Eastern Europe without Bulgaria, Poland and Romania

Markus Pavelic
Tel.: +49 94 35 3 91-3463
Mobile: +49 171 56 74 713

France, Spain, Portugal, Monaco, Andorra

Christophe Rodriguez
Mobile: +33 640 94 34 32
E-mail: christophe.rodriguez@deutsche-steinzeug.de

Korea, Taiwan, Hong Kong, Thailand, China, Japan, Singapore, Indonesia, The Philippines, Malaysia, Brunei, Vietnam, Myanmar, Laos, Cambodia

Jeffrey Lung
Mobile: +852 51 67 36 66
E-mail: jeffrey.lung@dsk-asia.com

Australia / New Zealand, Bulgaria, Cyprus, Egypt, Greece, India, Iran, Iraq, Libya, Middle East, Namibia, Poland, Romania, Sudan South Africa and Turkey

Patric Kakoschky
Tel.: +49 94 35 3 91-34 47
Mobile: +49 160 741 79 06
E-mail: patric.kakoschky@deutsche-steinzeug.de

Northern Europe, Baltic States, Canada, Great Britain, Ireland

Rolf Klebl
Tel.: +49 94 35 3 91-33 26
Mobile: +49 160 742 88 39
E-mail: rolf.klebl@deutsche-steinzeug.de

Italy

Virginio Quirci
Mobile: +39 (335) 5360808
E-mail: virginio.quirci@deutsche-steinzeug.de

Switzerland

Deutsche Steinzeug Schweiz AG
Renato Borsani
Tel.: +41 41 632 50 60
E-mail: renato.borsani@deutsche-steinzeug.ch

USA

DSA Deutsche Steinzeug America, Inc.
Tel.: +1 770 442 55
Fax: +1 770 442 55
E-mail: udo.reich@agrob-buchtal.com
E-mail: udo.reich@drytilenorthamerica.com
E-mail: info@agrob-buchtal.com
Internet: www.agrob-buchtal.com

Latin America

Diego Chavez
Tel.: +591 76 34 04 22
E-mail: diego@buchtal.latam.com
Internet: www.gc latinoamerica.com

Project: Alsterschwimmhalle / Location: Hamburg, Germany / Architect: gmp Architekten, Hamburg, Germany / Series: Chroma / Photo: Jochen Stüber





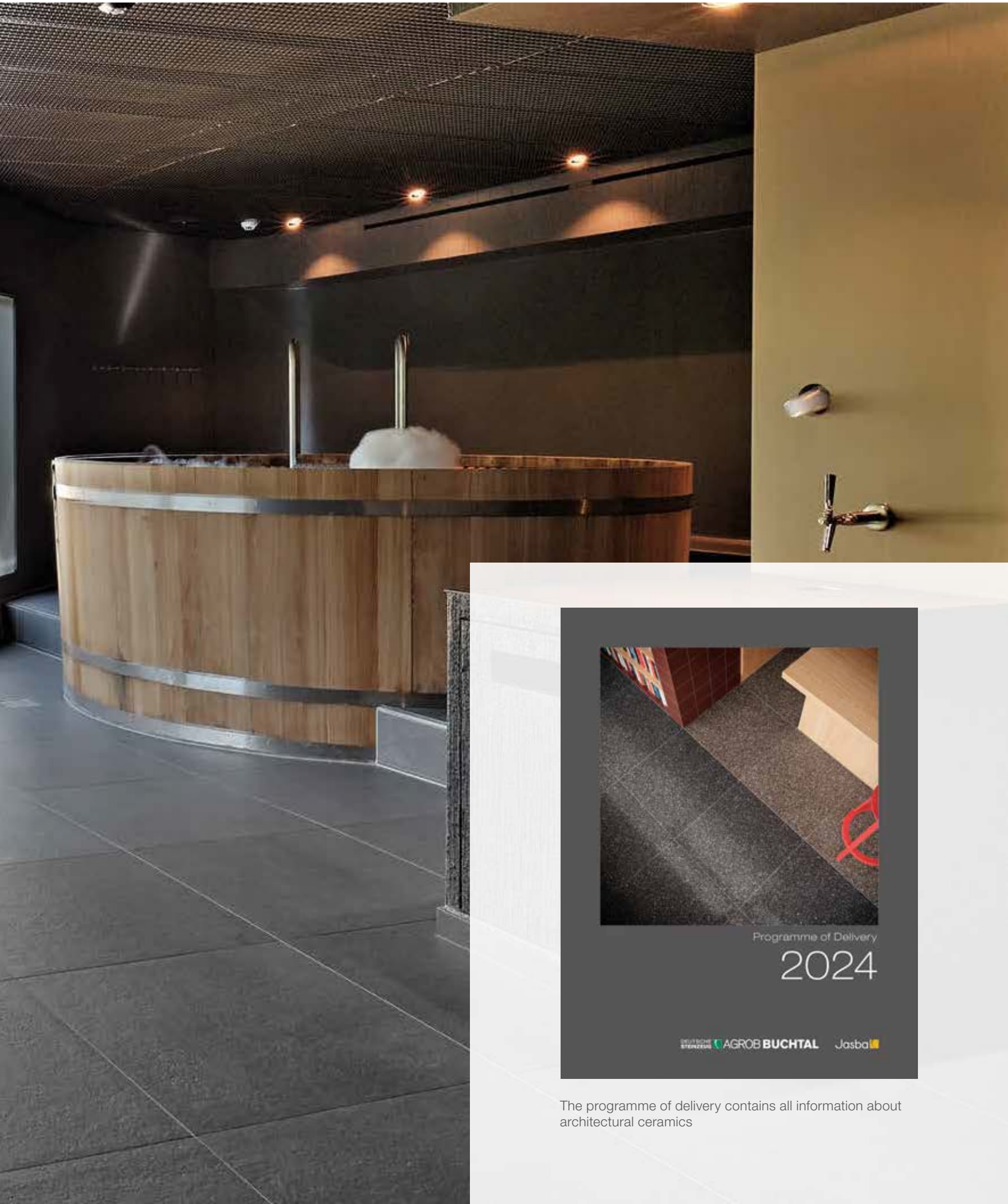

The programme of delivery contains all information about architectural ceramics





Easy to find

Each individual series is always represented as follows:

















- Color chart
- Short description
- Product specifications

- 1 **Series name;** sort of material (see page 279) and relevant product standard (see page 280)
- 2 **Schematic arrangement of the models** from left to right: Standard models from small to large: in the case of extruded split tiles, at first rectangular and then square models from small to large, fittings/special pieces
- 3 **Peculiarities** of the model
- 4 **Model number** (only in the case of extruded split tiles)
- 5 **Nominal dimensions** = work size + recommended joint width in centimetres and inches
Work size = only material dimensions without joint
- 6 **Surface quality**
- 7 **Logistic product specifications**
- 8 **Product standard**
- 9 **Slip-resistance classification:**
Barefoot areas/public and industrial areas (see pages 252 - 253 and 286 and the following)
- 10 **Stress groups 1-5;** orientation help for the industrial and commercial sector (see pages 281 - 282)
- 11 **Article number**
- 12 **Abrasion**
In the case of glazed materials according to stress groups 1 - 5; (see pages 282 - 283)
- 13 **Designation and/or number of color**
- 14 **Price group** (pricing unit in brackets)
- 15 **Color Shade Variation**
("Color shade variation" refers to the variations in color between the tiles of a certain color, i.e. the degree of shading. Our products are classified into 4 shading coefficients.)

- V0** No variation / no play of colors
- V1** Low variation / low play of colors
- V2** Medium variation / medium play of colors
- V3** High variation / high play of colors
- V4** Strong variation / strong play of colors

402		PLURAL NON-SLIP 1		
		stoneware		
		2 Mosaic^{2/4}		
		2.5 x 2.5 cm	5 x 5 cm	10 x 10 cm
				
				
		3 Sheet: 297 x 297 mm Sheet: 297 x 297 mm Sheet: 297 x 297 mm		
5	Nom. dim. - cm/in	2.5 x 2.5 / 1 x 1	5 x 5 / 2 x 2	10 x 10 / 4 x 4
	Work size	23 x 23 x 6.5 mm	47 x 47 x 6.5 mm	97 x 97 x 6.5 mm
6	Surface	smooth, matt	smooth, matt	smooth, matt
	m ² - pieces	11 sheets	11 sheets	11 sheets
	m ² - kg	12.100	12.331	13.101
	Bundle - pieces	11 sheets	11 sheets	11 sheets
7	Bundle - m ²	1.000	1.000	1.000
	Bundle - kg	12.100	12.331	13.101
	Pallet - m ²	48.000	64.000	64.000
	Pallet - kg	580.800	789.184	838.464
8	Product standard	Bib	Bib	Bib
	Slip resistance	R10/B	R10/B	R10/B
9	Stress group	1	1	1
10	neutral 10			
11		4 902-2120H 11	905-2120H 14	910-2120H
13	(active white) 15 	Price gr. A238 (m ²)	Price gr. A205 (m ²)	Price gr. A166 (m ²)

The following symbols are used:

-  Hytect[®] Hytect surface (for description, refer to pages 8-9 and 285)
-  Protecta surface upgrading (for description, refer to page 285)
-  Novelties
-  no shodfoot traffic
-  Rectified
-  Conically rectified
-  Rectified wall tiles with rounded/ground edges
-  Make-to-order production: return and/or cancellation of ordered products not possible
-  Orientation aid for the blind analogue to the requirements of DIN 32984
-  Frost-resistant
-  **R9** Slip-resistant
-  **B** Slip-resistant / Barefoot areas
-  Made in Germany
-  Glued thermoplastically
-  also available in other colors
-  6 mm tile



This brochure was printed on paper with FSC[®] certificate. By purchasing FSC products, we support responsible forest management subject to controls according to the stringent social, ecological and economical criteria of the Forest Stewardship Council[®].



Management System
ISO 9001:2015



www.tuv.com
ID 9000027001

AGROB BUCHTAL GmbH
Buchtal 1, D-92521 Schwarzenfeld
Tel.: +49 (0) 94 35-391-0
Fax: +49 (0) 94 35-391-34 52

E-Mail: info@agrob-buchtal.de
Internet: www.agrob-buchtal.de

02/2024, www.assenmacher.net

The publisher does not assume liability for misprints.
Color deviations when compared to the original products may occur as a result of printing.

