



Create your
SANCTUARY





The Caroma story

With over 75 years of experience, Caroma believes that quality bathrooms have to be a balance of form, function and luxury. Bathrooms are spaces where we put a personal touch on our homes. Caroma can enable you to enjoy bathroom experiences that both complement and elevate your lifestyle, from an energising morning start to an indulgent relaxing moment of luxury.

Designed for New Zealanders of different tastes, needs and from all walks of life, Caroma's wide range of classic to artisanal styles, smart designs and sustainable innovations, provide you with everything you need to create the sanctuary of your dreams.



Contents

- 05 Luna Collection
- 36 Tribute Collection
- 48 Urbane Collection
- 72 Liano Collection
- 104 Contura Collection
- 124 Notes







LUNA

BATHROOM COLLECTION





Caroma Classic is our most popular and affordable range of bathroom products. Loved by New Zealanders for its proven reputation of high-quality construction, durability and longevity, these designs have become classics in homes across the country.

The Classic collection brings everyday luxury experiences through classic styles and functional design for people seeking DIY and good value bathroom products. So, you can create the sanctuary of your dreams, without compromise.

“With all your bathroom needs covered, the **Luna** collection delivers a consistent and modern look throughout.”



A handwritten signature in black ink that reads 'LDM'.

- Luke Di Michiel,
Caroma Industrial Designer



LUNA

The Luna collection offers timeless and enduring bathroom essentials that are well-designed with Australasian ingenuity to suit your lifestyle.

The extensive product range features soft curves and sleek, modern designs which suit almost any bathroom and are practical for an everyday luxury bathroom experience.













Create your *sanctuary*



①

Luna Contemporary
Overhead Shower
System On Rail
90383C4E



③

Luna Above
Counter Basin
899000W



⑤

Luna Tower
Basin Mixer
68183C5A



⑥

Luna Bath/
Shower Mixer
68184C



②

Luna Wall Faced Invisi
Series II Toilet Suite
844910W



④

Luna Contemporary Single
Towel Rail 630mm
99612C



⑦

Luna Contemporary
Toilet Roll Holder
99607C



⑧

Luna Contemporary
Robe Hook
99608C



1

6

7

8

9

2

3

10

4

12



Create your *sanctuary*



①
Luna Contemporary
Back to Wall Bath
1400
LU4WFW



②
Luna
Contemporary
Multi Function
Hand Shower
90385C4F



④
Luna Inset
Vanity Basin
899215W



⑤
Luna Contemporary
Double Towel Rail
630mm
99614C



③
Luna
Cleanflush®
Wall Faced
Toilet Suite
844810W



⑥
Luna Contemporary
Straight Arm SQ
Flange 410MM
90389C

⑦
Luna Contemporary
Overhead Shower
Head Only
90386C4E



⑧
Luna
Contemporary
Metal Shelf
99610C



⑨
Luna Bath/
Shower Mixer
With Diverter
68185C



⑩
Luna Standard
Basin Mixer
68181C5A



⑪
Luna Wall Basin/
Bath Mixer
68186C5A



⑫
Luna
Contemporary
Toilet Roll Holder
99607C

Create your *sanctuary*



①
Luna Four Tile
Flange Bath 1675
LU7W

⑤
Luna Close
Coupled S Trap
Back Entry
Toilet Suite
844710W



②
Luna
Contemporary
Multi Function
Rail Shower
90384C3A



③
Luna Semi
Recessed Basin
(Without Tap
Landing)
873500W

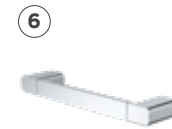

⑥
Luna
Contemporary
Hand Towel Rail
99611C



⑦
Luna
Contemporary
Toilet Roll Holder
99607C



④
Luna Contemporary Single Towel Rail 630mm
99612C



⑧
Luna
Contemporary
Robe Hook
99608C



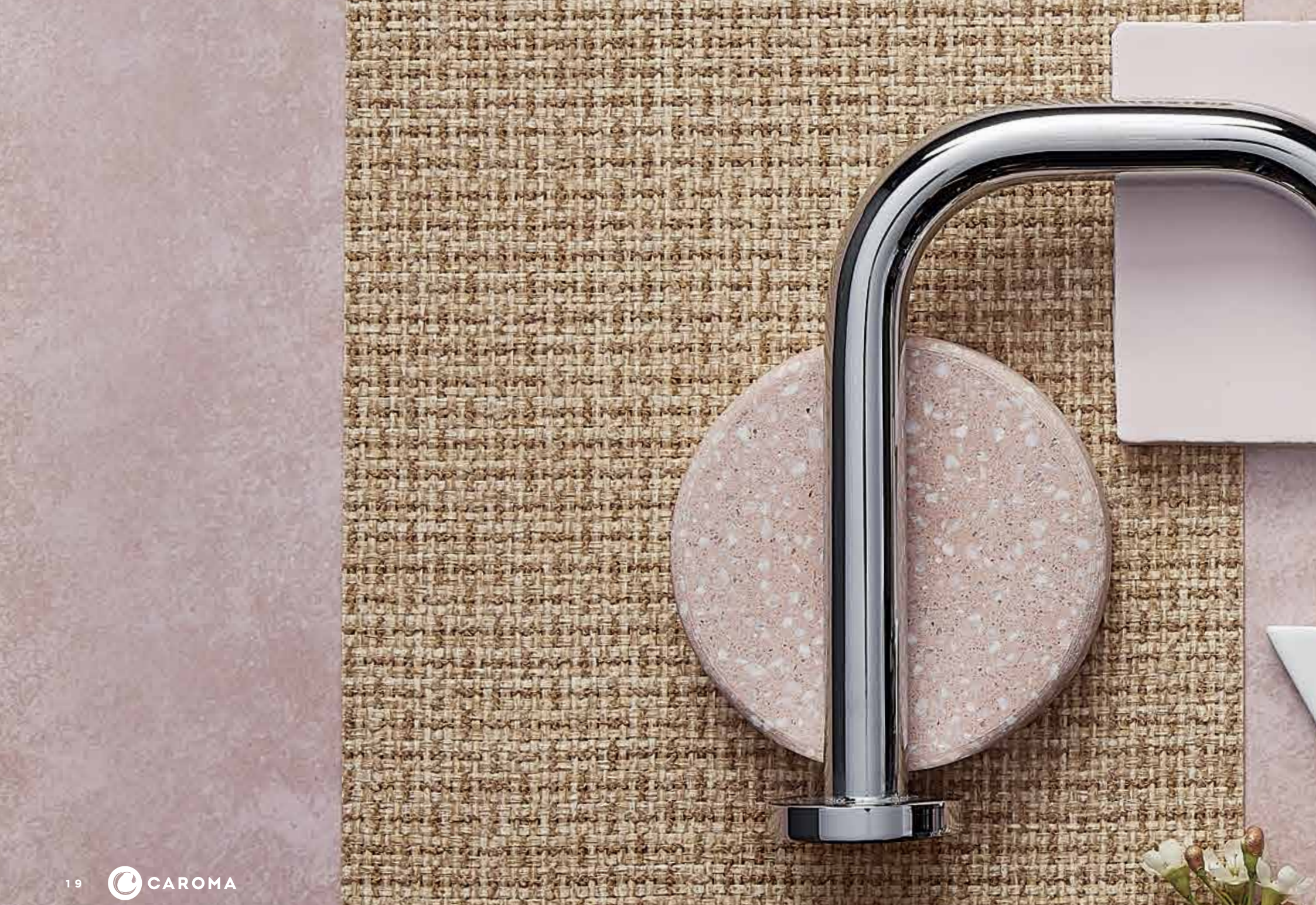



Basins

Luna basins are curved and classic in their design, making them a stylish choice for your bathroom that will stand the test of time.

With many style and size options available, you'll be spoiled for choice when selecting basins for a small ensuite through to a large family bathroom.

- Crafted from highly durable vitreous china that has great durability, sanitary and stain resistant properties
- Available in above counter, semi recessed, inset and wall basin styles
- Includes flush fitting plug and waste - optional pop up plug and waste available
- 10 year warranty

ABOVE COUNTER BASIN

Above counter basins are installed directly on top of a vanity with minimal installation requirements.

INSET BASIN

Inset basins are partially set into a vanity reducing the appearance of the basin rim without reducing the depth of the bowl.

SEMI RECESSED BASIN

Semi recessed basins partially overhang the vanity allowing you to maximise your basin size on applications with limited vanity space.

WALL BASIN

Wall basins are installed directly to the wall with no need for an additional vanity.



ABOVE COUNTER BASIN



Caroma wall basins are tested to withstand excess load up to 150kg

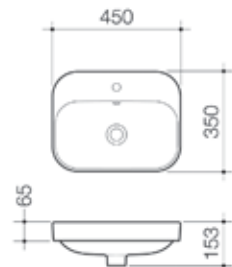

Luna Inset Vanity Basin

0 taphole 899205W
1 taphole 899215W
3 taphole 899235W

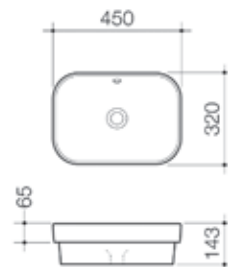

**Luna Inset Vanity Basin
(Without Tap Landing)**

0 taphole 899105W

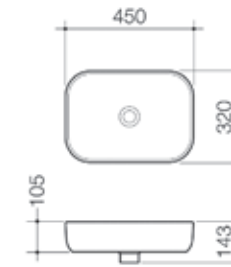

Luna Above Counter Basin

0 taphole 899000W

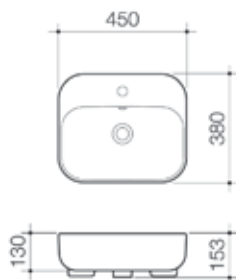

Luna Semi Recessed Basin

0 taphole 873605W
1 taphole 873615W

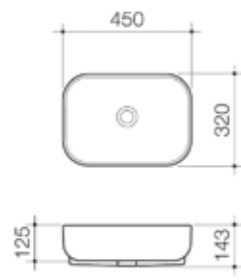

**Luna Semi Recessed Basin
(Without Tap Landing)**

0 taphole 873500W



Luna Shelf Wall Basin

0 taphole 873905W
1 taphole 873915W
3 taphole 873935W

Right hand shelf
and left hand shelf
available

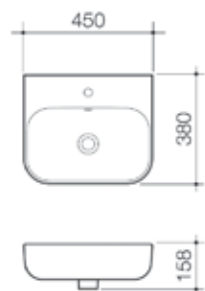

Luna Wall Basin

0 taphole 874205W
1 taphole 874215W
3 taphole 874235W

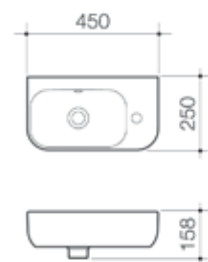

Luna Hand Wall Basin

1 taphole 873715W



Luna Waste

687329C

Showers

A sleek, modern shower will not only enhance the appearance of any bathroom but also your daily bathing experience.

Our Luna range of eco-friendly showers are engineered with a superior water saving rating, without any compromise on performance.

- Long lasting chrome finish
- Includes silicone nozzles and premium Silverflex shower hose for durability and easy cleaning
- WELS 4 star rated
- 10 year warranty

FIXED SHOWER

A fixed arm with a pivoting head either from the wall or ceiling for a clean stylish look.

HAND SHOWER

Provides added functionality to a fixed wall option with the ability to remove the handpiece.

SHOWERS ON RAILS

Convenient, adjustable height rail for ultimate control.





Luna Contemporary Overhead Shower System On Rail

WELS 4 star rated, 6-7.5L/min
90383C4E

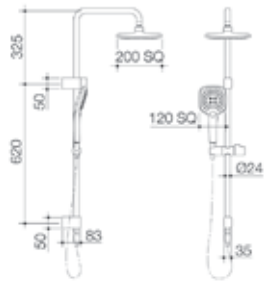

Luna Contemporary Overhead Shower Head Only

WELS 4 star rated, 6-7.5L/min
90386C4E

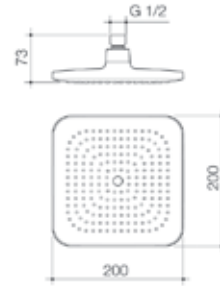

Luna Contemporary Fixed Overhead Shower

WELS 4 star rated, 6-7.5L/min
90391C4E

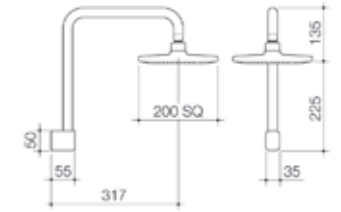

Luna Contemporary Multi Spray Function Rail Shower

WELS 4 star rated, 4.5-6L/min
90384C4F

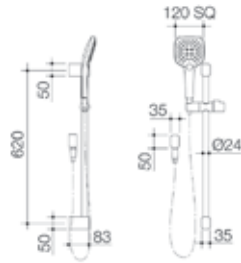

Luna Contemporary Ceiling Shower Arm 210mm

90388C

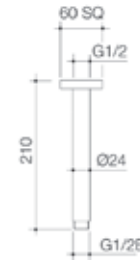

Luna Contemporary Lever Shower Set

WELS 3 star rated, 7.5-9L/min
90332C3A

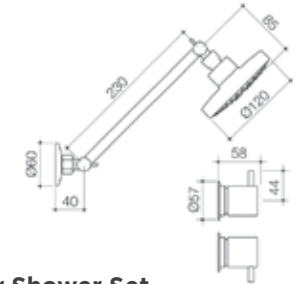

Luna Contemporary Multi Function Hand Shower

WELS 4 star rated, 4.5-6L/min
90385C4F



Luna Contemporary Ceiling Shower Arm 410mm

90389C



Luna Contemporary Ceiling Shower Arm

Right angle
90390C



Baths

Our range of Luna baths feature soft lines for a modern, minimalistic look. The gentle recline allows you to lie back and relax in style.

- Crafted from stain and scratch resistant sanitary grade acrylic
- Available in freestanding, back to wall, island and four tile flange styles
- Includes flush fitting plug and waste - optional pop up plug and waste
- 10 year warranty

FREESTANDING BATH

The Luna freestanding bath is only 1400mm in length, meaning that even small bathrooms can have this luxurious style of bath.

BACK TO WALL FREESTANDING BATH

The Luna back to wall bath combines the luxury of a freestanding bath with the practicalities of an island bath. Sitting flush to the wall means it is not only easy to clean but opens up the choice of tapware to wall bath mixers.

ISLAND BATHS

Island baths are recessed into a constructed frame which is usually finished using tiles or stone leaving only the small raised rim of the bath visible. The island bath offers extra room around the bath, perfect for candles, a sitting ledge, or the kids' toys.

FOUR TILE FLANGE BATHS

This style is necessary for a bath that will also be used as a shower. It works to redirect the shower spray run-off directly back into the bath without the moisture damaging the walls.



FREESTANDING BATH



ISLAND BATH

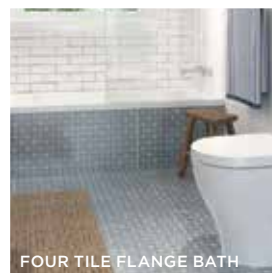

FOUR TILE FLANGE BATH

BACK TO WALL FREESTANDING BATH



Luna Contemporary Freestanding Bath

1400

LU4FSW

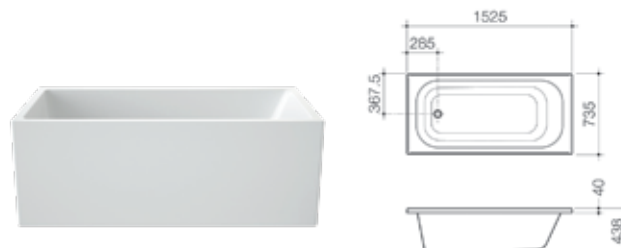

Luna Four Tile Flange Bath

1525

LU5W

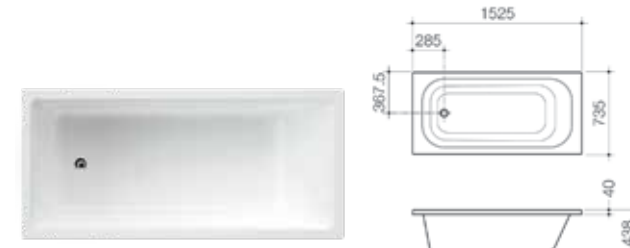

Luna Island Bath

1525

LU5ISW



Luna Contemporary Back to Wall Bath

1400

LU4WFW

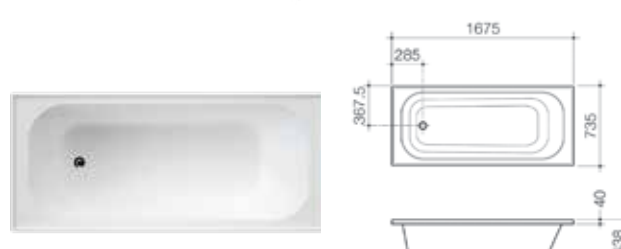

Luna Four Tile Flange Bath

1675

LU7W

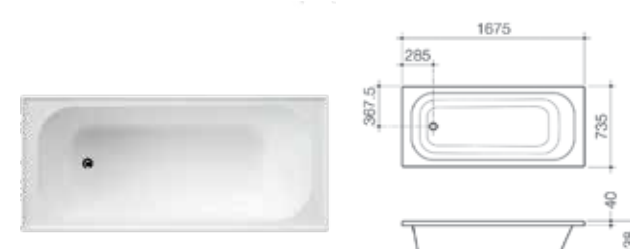

Luna Island Bath

1675

LU7ISW



Mixers

The subtle curves of the Luna mixer range bring a modern but timeless feel to your bathroom.

- Hard-wearing solid brass construction with durable chrome finish
- Available in 3 different heights to suit your basin type
- Ultraflex PEX hoses provide superior durability and cleanliness while easy clean silicone aerator prevents limescale build up
- WELS 4 or 5 star rated
- 10 year warranty

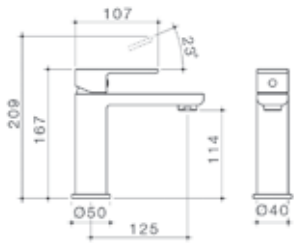

Luna Standard Basin Mixer

WELS 5 star rated, 6L/min
68181C5A

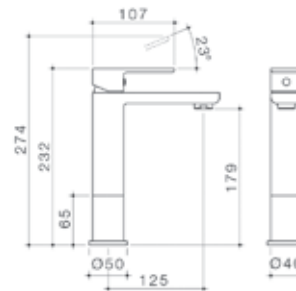

Luna Mid Basin Mixer

WELS 5 star rated, 6L/min
68182C5A

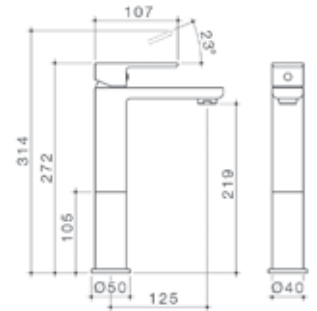

Luna Tower Basin Mixer

WELS 5 star rated, 6L/min
68183C5A

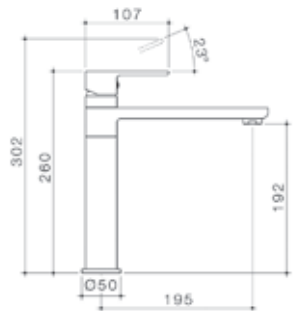

Luna Sink Mixer

WELS 4 star rated, 7.5L/min
68188C4A

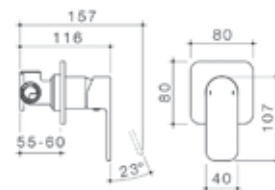

Luna Bath/Shower Mixer

Without Diverter
68184C

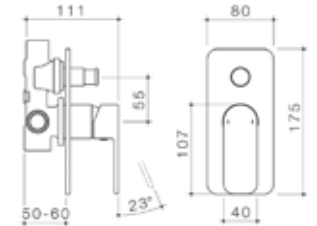

Luna Bath/Shower Mixer With Diverter

With Diverter
68185C

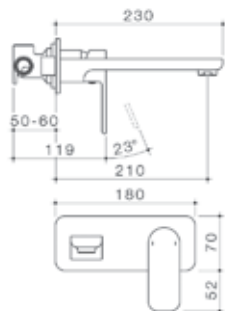

Luna Wall Basin/Bath Mixer

WELS 5 star rated, 6L/min
68186C5A



Luna Wall Basin/Bath Outlet

WELS 5 star rated, 6L/min
68187C5A

Toilet suites

Our Luna range of toilet suites feature Caroma patented Cleanflush® technology. Caroma Cleanflush® is our most effective and hygienic toilet. Our patented design features revolutionary rimless technology that delivers the next generation of toilets: easy to clean and water efficient with superior hygiene.

- Designed in Australia
- Available in wall faced or close coupled: wall faced options include Caroma's patented Uni-Orbital® connector for ease of installation
- Back entry or bottom inlet cistern: universal trap for S or P installations
- WELS 4 star rated
- 10 year warranty

INVISI WALL FACED TOILET SUITES (BEHIND THE WALL / CONCEALED)

The toilet pan sits on the floor and is connected to a cistern concealed inside the wall cavity, ceiling or under counter.

WALL FACED TOILET SUITE (OR BACK TO WALL)

The toilet pan sits flush to the wall with the cistern mounted directly on top.

CLOSE COUPLE TOILET SUITE

The toilet pan sits on the floor with the cistern mounted directly on top, leaving a small gap between the pan and the wall.



FLOW SPLITTER
Powerful flush for whole bowl clean



FLOW CHANNELS
Controlled water flow eliminates splash back



FLOW BALANCER
Precise flush stream effectively clears the bowl



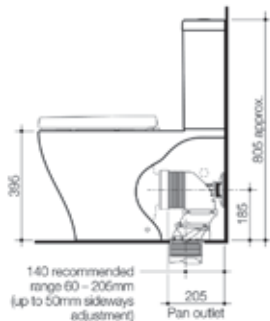

Luna Cleanflush® Wall Faced Toilet Suite

WELS 4 star rated, 4.5/3L (3.5L avg/flush)

Bottom Inlet* 844810W
Back Entry* 844820W

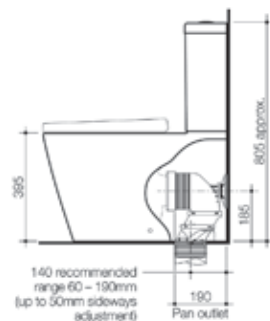

Luna Square Cleanflush® Wall Faced Toilet Suite

WELS 4 star rated, 4.5/3L (3.5L avg/flush)

Bottom Inlet* 846410W
Back Entry* 846420W

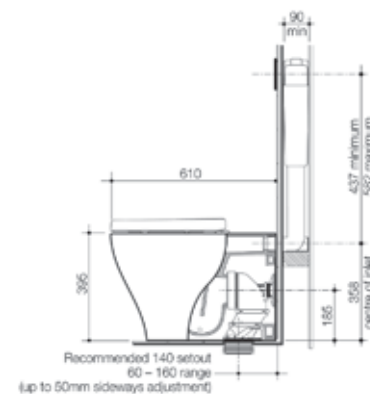

Luna Cleanflush® Wall Faced Invisi Series II® Toilet Suite

WELS 4 star rated, 4.5/3L (3.5L avg/flush)

Back Entry* 844910W *Buttons sold separately

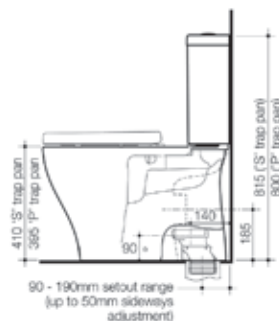

Luna Cleanflush® Close Coupled P Trap Toilet Suite

WELS 4 star rated, 4.5/3L (3.5L avg/flush)

P Trap Bottom Inlet* 844720W
P Trap Back Entry* 829740W

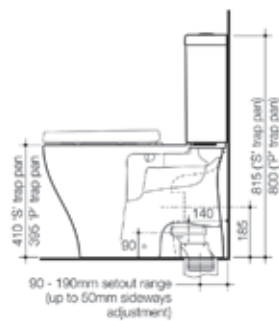

Luna Cleanflush® Close Coupled S Trap Toilet Suite

WELS 4 star rated, 4.5/3L (3.5L avg/flush)

S Trap Bottom Inlet* 844710W
S Trap Back Entry* 829730W

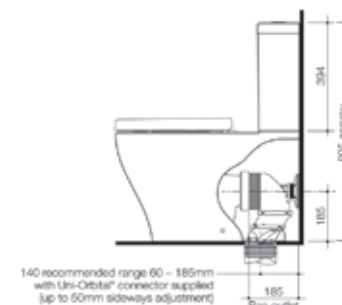

Luna Wall Faced Toilet Suite

WELS 4 star rated, 4.5/3L (3.5L avg/flush)

Bottom Inlet* 829710W
Back Entry* 829720W

*Bottom Inlet - for installation flexibility
*Back Entry - for a concealed connection



Accessories

Our Luna range of accessories bring the finishing touch to your bathroom. The range of towel rails, hooks, shelves and toilet roll holders will complement the rest of your choices from the Luna collection.

- Durable metal construction with long lasting chrome finish
- Dual fixings for added strength
- 1 year warranty

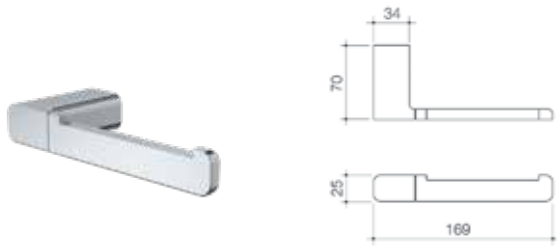

Luna Contemporary Toilet Roll Holder

99607C

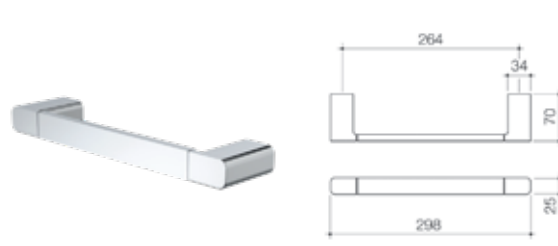

Luna Contemporary Hand Towel Rail

99611C

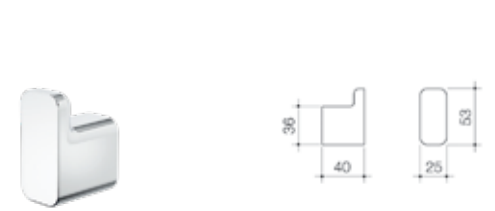

Luna Contemporary Robe Hook

99608C

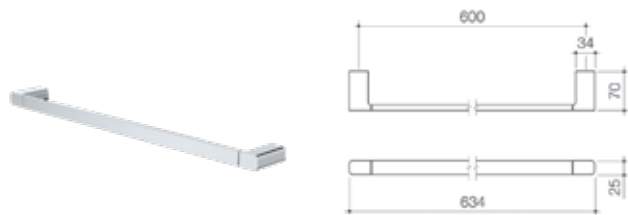

Luna Contemporary Single Towel Rail 630mm

99612C

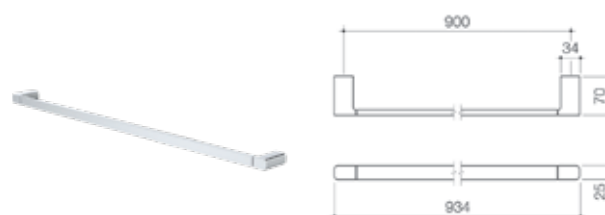

Luna Contemporary Single Towel Rail 930mm

99613C

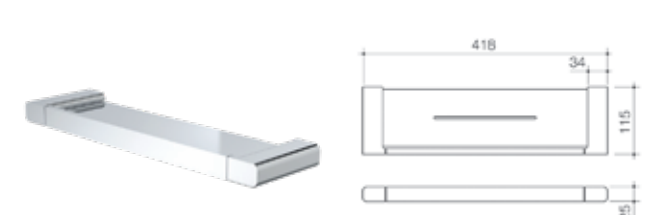

Luna Contemporary Metal Shelf

99610C

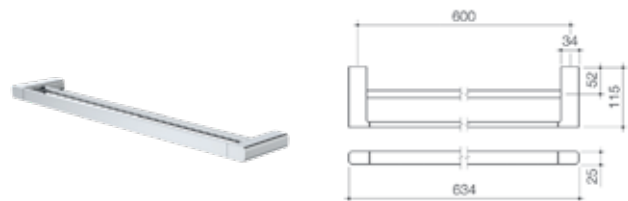

Luna Contemporary Double Towel Rail 630mm

99614C

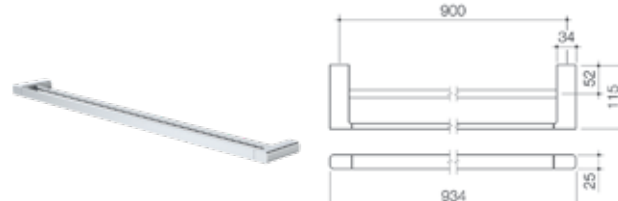

Luna Contemporary Double Towel Rail 930mm

99615C







With over 75 years of experience, we believe quality bathrooms are a balance of form, function and looks. Our designs and innovation bring to life a guiding vision of creating sustainable luxury. Design that enables you to enjoy bathroom experiences that both complement and elevate your lifestyle, from an energising morning start to an indulgent, relaxing moment of luxury, all underpinned by sustainability.

Designing for Australians and New Zealanders, from all walks of life, with different tastes and needs; we have a wide range of classic to artisanal styles, smart designs and sustainable innovations providing you with everything you need to create the *sanctuary of your dreams.*

www.caroma.co.nz

© Copyright 2019. Caroma Industries Ltd. ABN 35 000 189 499. All rights reserved. Material and design specifications subject to change without notice. Product colour reproduction is as near to actual product colour as production methods allow. Warning: Products in this brochure are the subject of registered designs and patents. ® is a registered trademark of Caroma Industries. This brochure relates to Australian products only and some product, design or specifications may differ in other countries.



TRIBUTE

BASIN COLLECTION





Caroma Classic is our most popular and affordable range of bathroom products. Loved by New Zealanders for its proven reputation of high-quality construction, durability and longevity, these designs have become classics in homes across the country.

The Classic collection brings everyday luxury experiences through classic styles and functional design for people seeking DIY and good value bathroom products. So, you can create the sanctuary of your dreams, without compromise.

“The **Tribute** collection of basins are a must in bringing modern luxury to your bathroom.”



A handwritten signature in black ink, appearing to read "LDM".

- Luke Di Michiel,
Caroma Industrial Designer



TRIBUTE

The Tribute collection features a stylish array of basins to suit a range of bathroom and lifestyle needs.

Designed and built with Australasian ingenuity to bring the best in modern design to your bathroom. Paired with tapware from the Luna collection, a Tribute collection basin is a must for an everyday luxury bathroom experience.





Basins

The Tribute collection, comprising of Artisan and Sculptural basins, feature modern and stylish thin rim design to suit a range of bathroom and lifestyle needs. Designed to be paired with tapware from the Luna collection, this range will bring a touch of everyday luxury to any bathroom experience.

- Designed in Australia
- Crafted from highly durable fireclay or from vitreous china
- Available in above counter, semi recessed, inset and wall basin styles
- Includes flush fitting plug and waste
- 10 year warranty

ABOVE COUNTER BASINS

Above counter basins are installed directly on top of a vanity with minimal installation requirements.

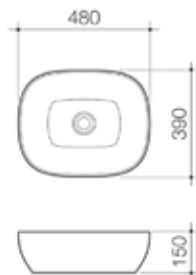

**Artisan Above Counter Basin
Curved Rectangle 480mm**

0 taphole 874900W

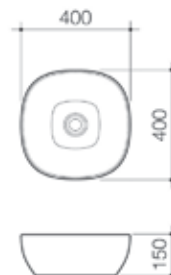

**Artisan Above Counter Basin
Curved Square 400mm**

0 taphole 874800W

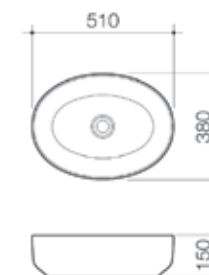

**Artisan Above Counter Basin
Oval 510mm**

0 taphole 874700W

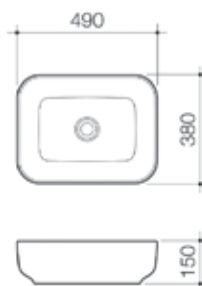

**Artisan Above Counter Basin
Rectangle 490mm**

0 taphole 874500W

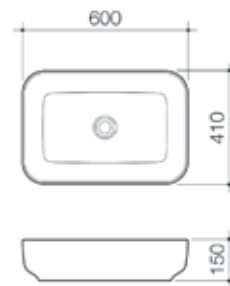

**Artisan Above Counter Basin
Rectangle 600mm**

0 taphole 874600W



**Artisan Above Counter Basin
Round 405mm**

0 taphole 874300W

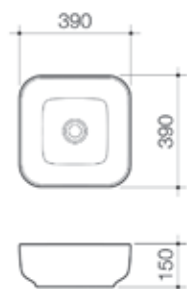

**Artisan Above Counter Basin
Square 390mm**

0 taphole 874400W

ARTISAN WILL SOON TRANSITION TO TRIBUTE

New range names are coming soon to Caroma. Our product will remain the same, but we are making it easier for our consumers and customers to identify what they need quickly.

Basins

INSET BASINS

Inset basins are partially set into a vanity reducing the appearance of the basin rim without reducing the depth of the bowl.



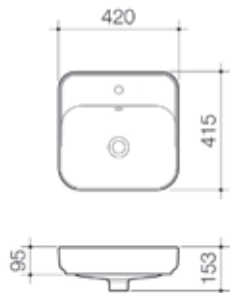

Sculptural Inset Basin 420mm

1 taphole 877415W
3 taphole 877435W

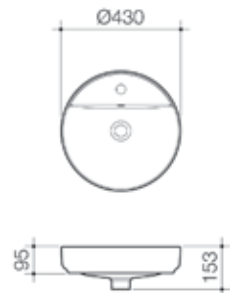

Sculptural Inset Basin 430mm

1 taphole 877315W

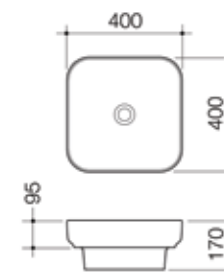

Sculptural Inset Basin 400mm

0 taphole 876800W

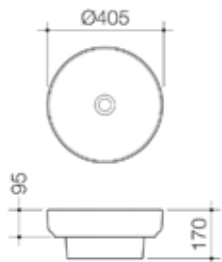

Sculptural Inset Basin 405mm

0 taphole 876700W

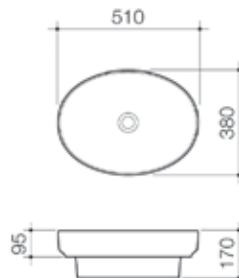

Sculptural Inset Basin 515mm

0 taphole 877000W

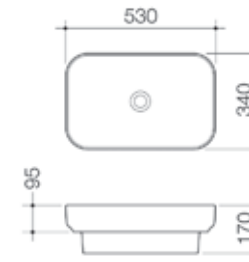

Sculptural Inset Basin 530mm

0 taphole 876900W

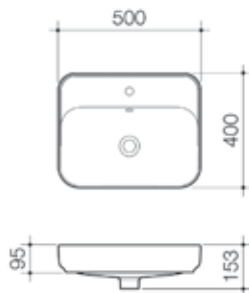

Sculptural Rectangle Inset Basin 500mm

1 taphole 877515W
3 taphole 877535W

SCULPTUTRAL WILL SOON TRANSITION TO TRIBUTE

New range names are coming soon to Caroma. Our product will remain the same, but we are making it easier for our consumers and customers to identify what they need quickly.



Basins

SEMI RECESSED BASIN

Semi recessed basins partially overhang the vanity allowing you to maximise your basin size on applications with limited vanity space.

WALL BASIN

Wall basins are installed directly to the wall with no need for an additional vanity.



Caroma wall basins are tested to withstand excess load up to 150kg



Sculptural Semi Recessed Basin 420mm

1 taphole 877715W
3 taphole 877735W



Sculptural Semi Recessed Basin 430mm

1 taphole 877615W



Sculptural Semi Recessed Basin 500mm

1 taphole 877815W
3 taphole 877835W



Sculptural Wall Basin 500mm

1 taphole 877915W
3 taphole 877935W



Sculptural Rectangle Right Hand Shelf Wall Basin 600mm

1 taphole 878015W
3 taphole 878035W



Sculptural Left Hand Shelf Wall Basin 600mm

1 taphole 878115W
3 taphole 878135W



With over 75 years of experience, we believe quality bathrooms are a balance of form, function and looks. Our designs and innovation bring to life a guiding vision of creating sustainable luxury. Design that enables you to enjoy bathroom experiences that both complement and elevate your lifestyle, from an energising morning start to an indulgent, relaxing moment of luxury, all underpinned by sustainability.

Designing for Australians and New Zealanders, from all walks of life, with different tastes and needs; we have a wide range of classic to artisanal styles, smart designs and sustainable innovations providing you with everything you need to create the *sanctuary of your dreams.*

www.caroma.co.nz

© Copyright 2019, Caroma Industries Ltd. ABN 35 000 189 499. All rights reserved. Material and design specifications subject to change without notice. Product colour reproduction is as near to actual product colour as production methods allow. Warning: Products in this brochure are the subject of registered designs and patents. ® is a registered trademark of Caroma Industries. This brochure relates to Australian products only and some product, design or specifications may differ in other countries.



URBANE

BATHROOM COLLECTION





Caroma Vogue Collection represents the best of Caroma's leadership in bathroom design and is sure to make a statement in any home.

Creating your own home has always been part of the New Zealand dream; the opportunity to design a unique space that both complements and elevates your individual style. The Caroma Vogue Collection will provide you the freedom to create your dream bathroom; one that enables an experience of personal luxury through customising key design elements.

The collection proudly represents fashionable Australasian styles, made from the highest quality materials and incorporates the latest in sustainable innovations.

“The beauty of the **Urbane** Collection is its ability to seamlessly integrate into a range of modern bathroom styles. Understated and simple design elements work together to create a clean and fresh look.”



A handwritten signature in black ink that reads 'LDM'.

- Luke Di Michiel,
Caroma Industrial Designer



URBANE

Urbane is a designer collection that will make a statement in any bathroom. This expressive collection embodies modern design with smooth curves and subtle accents.

Embracing a distinctly Australasian style, the Urbane Collection demonstrates designer looks with impeccable quality.







5

4

6

8

7

1

Create your *sanctuary*



① Urbane 1675 Back to Wall Freestanding Bath **UR7WFW**



② Invisi Series II® Round Dual Flush Plate & Buttons (Metal) **237088C**



④ Urbane Semi Recessed Basin **867215W**



③ Urbane Cleanflush® Invisi Series II® Wall Faced Toilet Suite **746300W**



⑤ Urbane Basin Mixer **98582C5A**



⑥ Urbane Wall Basin/Bath Mixer **98586C5A**



⑦ Urbane Multifunction Rail Shower with Overhead **98590C3A**

⑧ Urbane Bath/Shower Mixer **98584C**



⑨ Urbane Metal Shelf **98589C**



⑩ Urbane Toilet roll holder **98591C**



3

4

5

6

Create your *sanctuary*



①
Urbane 1675 Island Bath
UR71SW

② ③

Urbane Wall Basin/Wall Bath Mixer
98586B5A



④

Urbane Inset Basin
867115W



⑤

Urbane Cleanflush®
Wall Faced Toilet Suite
746300W



⑥

Urbane Toilet
Roll Holder
98591B







Basins

Our Urbane basins will make a fashionable statement in any modern bathroom.

With three different styles available, there's an Urbane basin to suit your bathroom requirements.

- Designed and engineered in Australia
- Crafted from high quality vitreous china that has great durability, sanitary and stain resistant properties
- Available in semi recessed, inset and wall basin styles
- Includes flush fitting white plug and chrome waste. Integrated overflow
- 10 year warranty

INSET BASINS

Inset basins are partially set into a vanity reducing the appearance of the basin rim without reducing the depth of the bowl.

SEMI RECESSED BASINS

Semi recessed basins partially overhang the vanity allowing you to maximise your basin size on applications with limited vanity space.

WALL BASINS (OR WALL MOUNTED)

Wall basins are installed directly to the wall with no need for an additional vanity.



WWW RECESSED BASIN

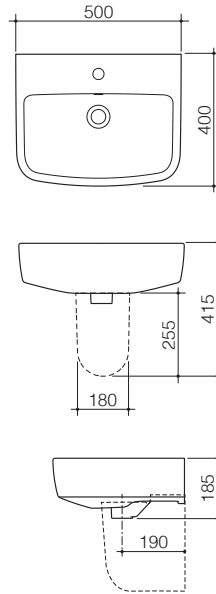

Urbane Wall Basin

1 taphole

867015W

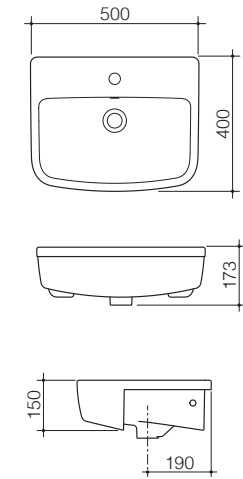

Urbane Semi Recessed Basin

1 taphole

867215W

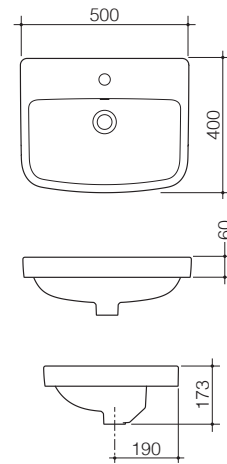

Urbane Inset Basin

1 taphole

867115W



Showers

Your shower is one of the most important aspects of your bathroom. Choosing the right type of shower for you and your families will ensure you have the best showering experience every time.

Our Urbane showers will make a modern designer statement in your bathroom.

- Available in polished chrome or matte black finish
- Includes silicone nozzles and premium smooth Silverflex shower hose for durability and easy cleaning
- WELS 3 star rated, 9L/min
- 10 year warranty

HAND SHOWER

Provides added functionality to a fixed wall shower option with ability to remove the handpiece.

Our Caroma Urbane showers include 2-spray functionality for a personalised showering experience.

RAIL SHOWER

Extremely practical, rail showers allow you to adjust the height of the shower head along the rail and at different angles.



Urbane Multifunction Rail Shower with Overhead

WELS 3 star rated, 9L/min
 Chrome 98590C3A
 Black 98590B3A



Urbane Multifunction Hand Shower

WELS 3 star rated, 9L/min
 Chrome 98593C3A
 Black 98593B3A



Urbane Multifunction Rail Shower

WELS 3 star rated, 9L/min
 Chrome 98588C3A
 Black 98588B3A

Baths

Our Urbane designer bath range embodies the best of modern style to create a statement for your bathroom.

- Plug and waste options available
- 10 year warranty

BACK TO WALL BATH

The Urbane back to wall bath combines the luxury of a freestanding bath with the practicalities of an island bath. Sitting flush to the wall means it is not only easy to clean but opens up the choice of tapware to wall bath mixers.

ISLAND BATH

Island baths are recessed into a constructed frame which is usually finished using tiles or stone leaving only the small raised rim of the bath visible. The island bath offers extra room around the bath, perfect for candles, a sitting ledge, or the kids' toys.

The Urbane Island bath has a high gloss finish with natural slip resistance, dual reclined ends and a centre waste position for added comfort. Plus sanitary grade acrylic resists chipping and has excellent heat retention qualities.



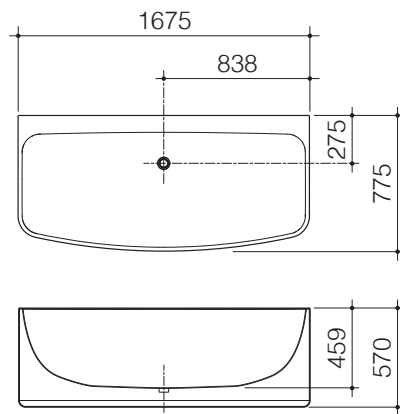

**Urbane 1675 Back to Wall
Freestanding Bath**

UR7WFW

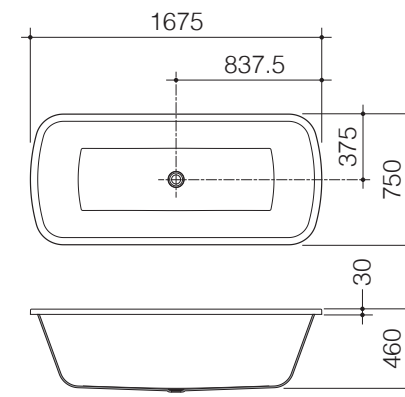

Urbane 1675 Island Bath

UR7ISW



Tapware

Make a bold statement with fashionable matte black or add a touch of modern elegance with polished chrome.

- Designed and engineered in Australia
- High quality solid brass construction
- Ultraflex PEX hoses provide superior durability and cleanliness while easy clean silicone aerator prevents limescale build up
- Includes ceramic disc cartridge to eliminate drips and minimise maintenance
- WELS 5 star rated, 6L/min
- 10 year warranty

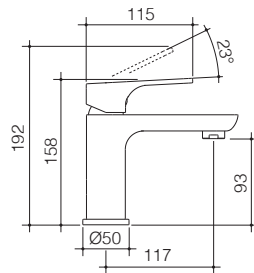

Urbane Basin Mixer

WELS 5 star rated, 6L/min
 Chrome 98582C5A
 Black 98582B5A

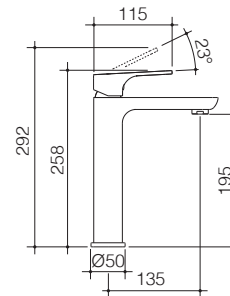

Urbane Tower Basin Mixer

WELS 5 star rated, 6L/min
 Chrome 98583C5A

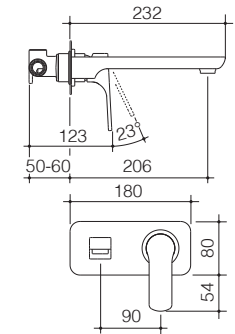

**Urbane Wall Basin/
 Bath Mixer**

WELS 5 star rated, 6L/min
 Chrome 98586C5A
 Black 98586B5A

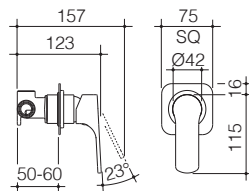

Urbane Bath/Shower Mixer

Chrome 98584C
 Black 98584B

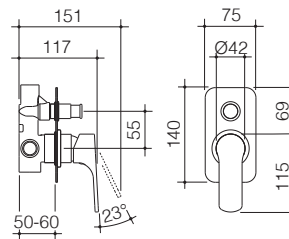

Urbane Bath/Shower Mixer with Diverter

Chrome 98585C
 Black 98585B

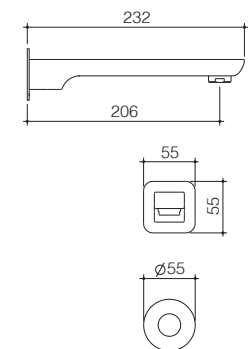

Urbane Bath Outlet

Chrome 98607C
 Black 98607B

Toilet suites

Caroma Cleanflush® is our most effective and hygienic toilet. Our patented design features revolutionary rimless technology that delivers the next generation of toilets: easy to clean and water efficient with superior hygiene.

- Designed and engineered in Australia
- Available in wall faced or wall hung styles. Wall faced options include Caroma's patented Uni-Orbital® connector for ease of installation
- Invisi Series II® buttons sold separately. Available in a range of colours and finishes to suit your style
- WELS 4 star rated, 4.5/3L (3.5L avg/flush)
- 10 year warranty

INVISI WALL FACED TOILET SUITES (BEHIND THE WALL/CONCEALED)

The toilet pan sits on the floor and is connected to a cistern concealed inside the wall cavity, ceiling or under counter.

INVISI WALL HUNG TOILET SUITES (BEHIND THE WALL/CONCEALED)

The toilet pan sits off the floor and is mounted directly to the wall and connected to a cistern concealed inside the wall cavity, ceiling or under counter.

WALL FACED TOILET SUITE

The toilet pan sits flush to the wall with the cistern mounted directly on top.



FLOW SPLITTER
Powerful flush for whole bowl clean



FLOW CHANNELS
Controlled water flow eliminates splash back



FLOW BALANCER
Precise flush stream effectively clears the bowl



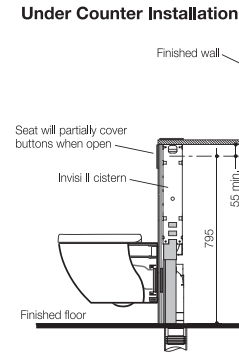
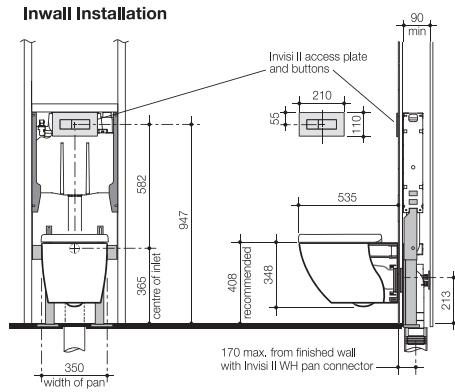

**Urbane Wall Hung
Invisi Series II® Toilet Suite**

WELS 4 star rated, 4.5/3L (3.5L avg/flush)	
ID IW IC	740500W
UC	740520W
SBW	740550W

Buttons sold separately

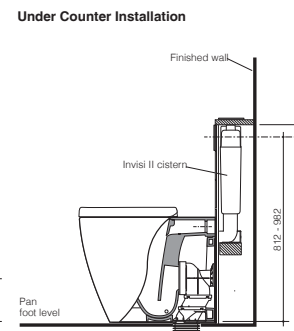
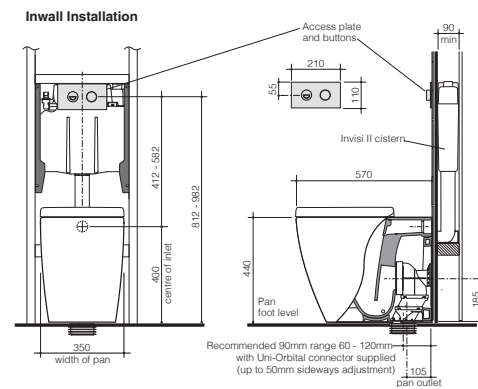

**Urbane Cleanflush® Wall Faced
Invisi Series II® Toilet Suite**

WELS 4 star rated, 4.5/3L (3.5L avg/flush)	
Soft Close BI	746100W

Buttons sold separately

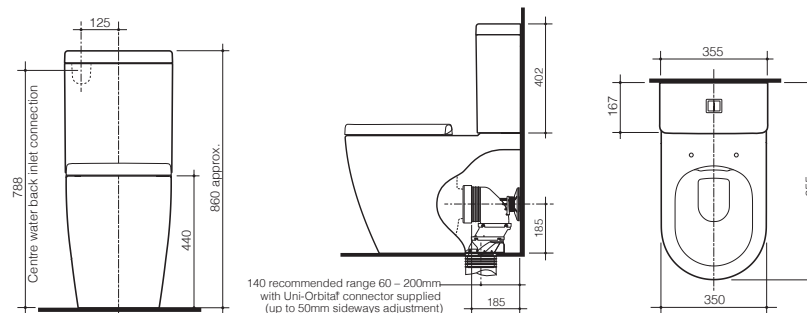

**Urbane Cleanflush®
Wall Faced Toilet Suite**

WELS 4 star rated, 4.5/3L (3.5L avg/flush)	
Soft Close Seat BE	746300W
Soft Close Seat BI	746200W



Accessories

Unify your bathroom design and enhance practicality with our range of Urbane accessories.

This range of products will complement the rest of your choices from the Urbane Collection and ensure your bathroom is efficiently organised.

- Durable metal construction
- Available in polished chrome or matte black finish
- 1 year warranty

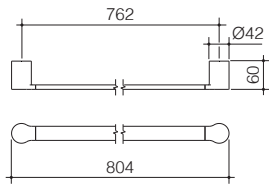

Urbane Single Towel Rail

Chrome 98588C
Black 98588B

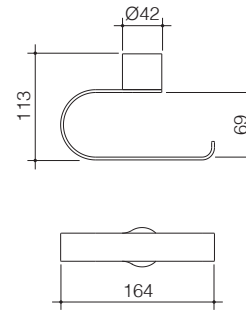

Urbane Toilet Roll Holder

Chrome 98591C
Black 98591B

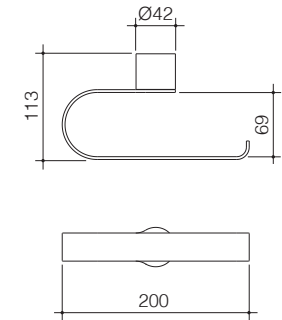

Urbane Hand Towel Ring

Chrome 98592C
Black 98592B

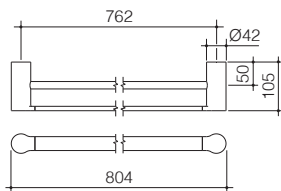

Urbane Double Towel Rail

Chrome 98587C
Black 98587B

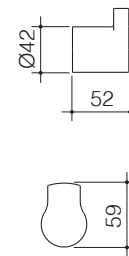

Urbane Robe Hook

Chrome 98590C
Black 98590B

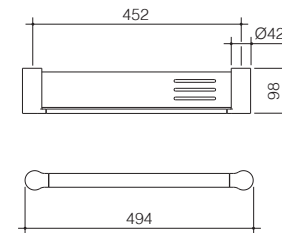

Urbane Bathroom Shelf

Chrome 98589C
Black 98589B



With over 75 years of experience, we believe quality bathrooms are a balance of form, function and looks. Our designs and innovation bring to life a guiding vision of creating sustainable luxury. Design that enables you to enjoy bathroom experiences that both complement and elevate your lifestyle, from an energising morning start to an indulgent, relaxing moment of luxury, all underpinned by sustainability.

Designing for Australians and New Zealanders, from all walks of life, with different tastes and needs; we have a wide range of classic to artisanal styles, smart designs and sustainable innovations providing you with everything you need to create the *sanctuary of your dreams.*

www.caroma.co.nz

© Copyright 2019. Caroma Industries Ltd. ABN 35 000 189 499. All rights reserved. Material and design specifications subject to change without notice. Product colour reproduction is as near to actual product colour as production methods allow. Warning: Products in this brochure are the subject of registered designs and patents. ® is a registered trademark of Caroma Industries. This brochure relates to Australian products only and some product, design or specifications may differ in other countries.



 **CAROMA**
VOGUE

LIANO

BATHROOM COLLECTION





Our Caroma Vogue Collection represents the best of Caroma's leadership in bathroom design and is sure to make a statement in any home.

Creating your own home has always been part of the New Zealand dream; the opportunity to design a unique space that both complements and elevates your individual style. The Caroma Vogue Collection will provide you the freedom to create your dream bathroom; one that enables an experience of personal luxury through customising key design elements.

The collection proudly represents fashionable Australasian styles, made from the highest quality materials and incorporates the latest in sustainable innovations.

“Minimalistic style, clean lines and symmetry defines the **Liano** Collection. It's the collection you need to make a statement in your home.”



A handwritten signature in black ink, appearing to read 'LDM'.

- Luke Di Michiel,
Caroma Industrial Designer



LIANO

The Caroma Liano Collection showcases the very best of modern Australasian design and is sure to make a statement in any home.

Featuring a full range of bathroom products that work together to create a harmonious bathroom design, Liano is the collection for those who want to create a unique bathroom sanctuary.











4

3

2

7



Create your *sanctuary*

①

Liano Cleanflush®
Easy Height Wall
Faced Toilet Suite
766450W



②

Liano Nexus
Inset Basin
665215W



③

Liano Basin Mixer
96193C6A



④

Liano Towel Rail
96120C



⑤

Liano Toilet
Roll Holder
96124C



⑥

Liano Robe
Hook
96125C



⑦

Liano Wall
Basin Mixer
96183C5A



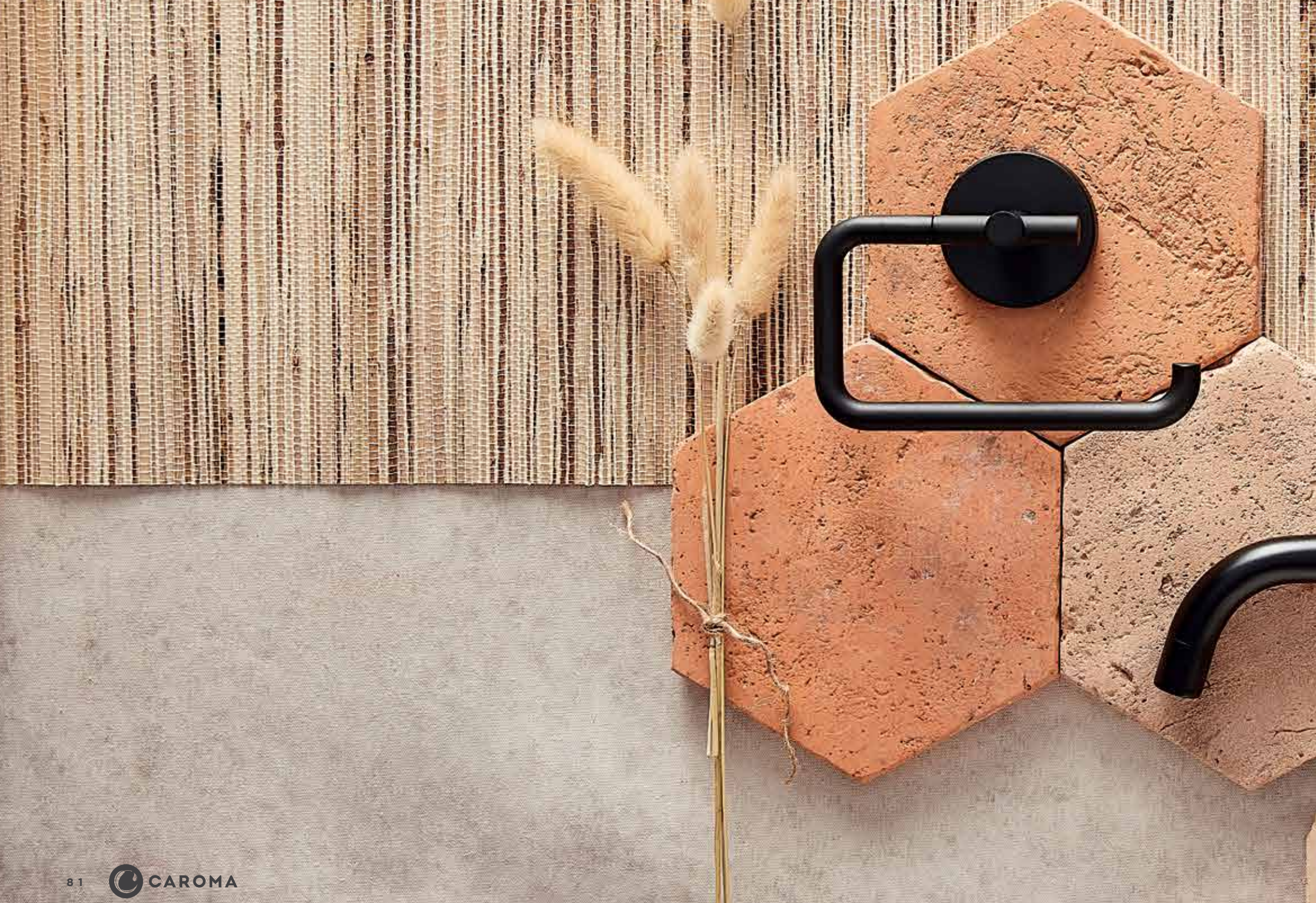





11

6

7

8

9

3

4

5

Create your *sanctuary*

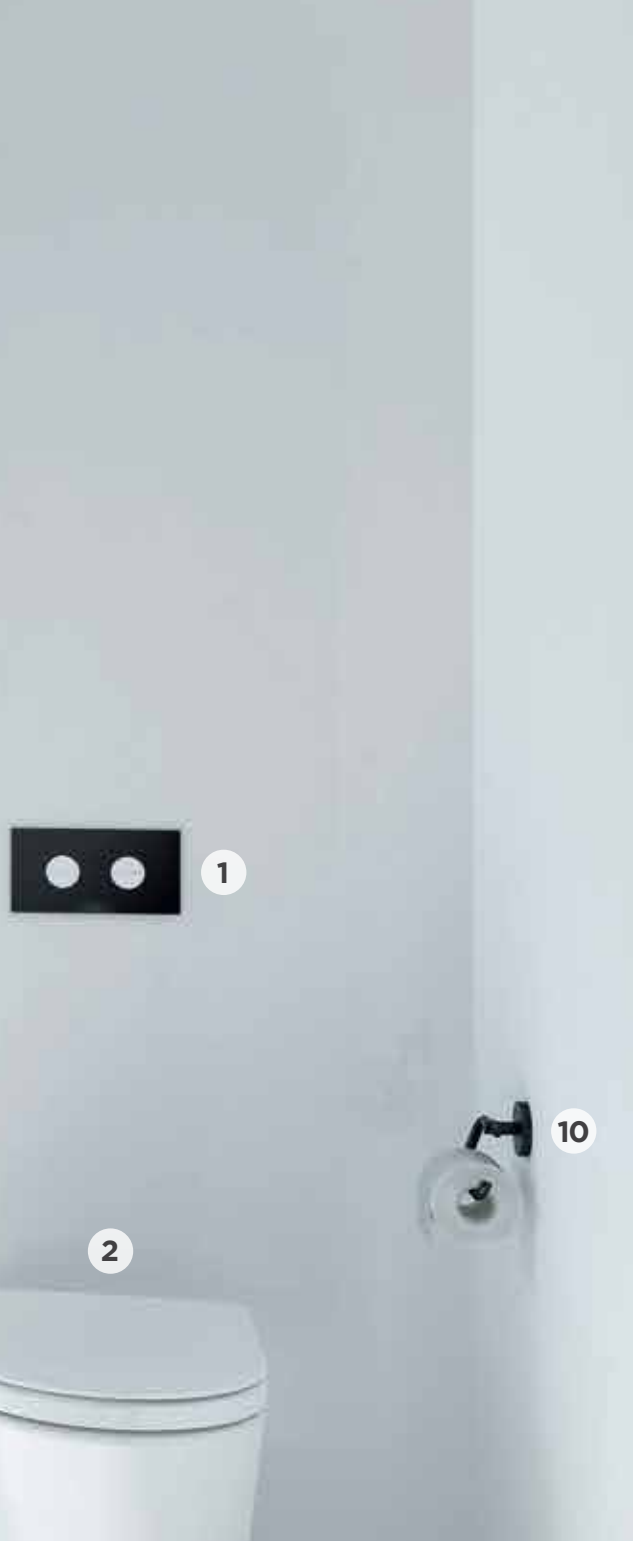

①

Invisi Series II® Round Dual
Flush Plate & Buttons (Metal)
Black w/ Chrome Buttons
237088BL



②

Liano Cleanflush® Invisi Series II®
Easy Height Wall Faced Toilet Suite
766350W



③

Liano Nexus
Basin Mixer
96193B6A

④

Liano Nexus 600
Wall Basin with
Shelf (Right Hand)
665315W



⑤

Eco Noir Bottle Trap
687295B



⑥

Liano Nexus
Overhead Rain
Shower
91051B3A



⑦

Liano Nexus Right
Angle Shower Arm
2464.04B

⑧

Liano Nexus
Bath/Shower Mixer
96130B



⑨

Liano Nexus
Hand Towel Ring
96122B



⑩

Liano Nexus
Toilet Roll Holder
96124B



⑪

Liano Nexus
Toilet Roll
Holder
96125B





Basins

Boasting sharp, symmetrical lines with an architectural, minimalist style, our Liano basins are available in multiple configurations to suit a range of bathroom design requirements.

- Designed and engineered in Australia
- Crafted from high quality vitreous china that has great durability, sanitary and stain resistant properties
- Available in semi recessed, inset, above counter, under counter and wall basin styles
- Includes flush fitting white plug and chrome waste. Integrated overflow
- 10 year warranty

WALL BASINS (OR WALL MOUNTED)

Wall basins are fixed directly to the wall with brackets and don't require a vanity for installation. Our Liano wall basins are ideal for saving space with a minimalistic look.

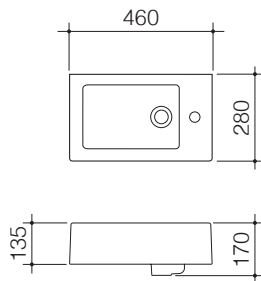

Liano Hand Wall Basin
649715W

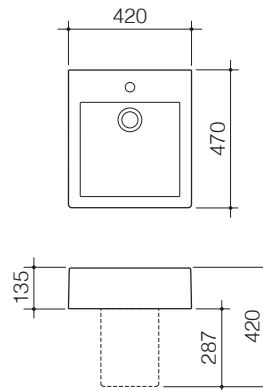

Liano Wall Basin
1 taphole 649315W

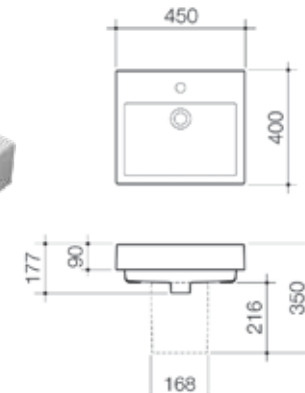

Liano Nexus Wall Basin
No taphole 665605W
1 taphole 665615W
Shroud 812260W *Shroud sold separately

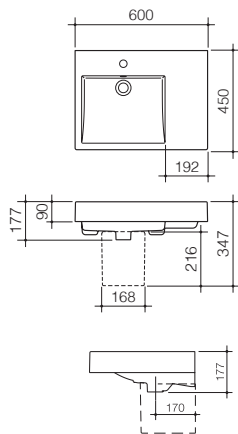

Liano Nexus 600 Wall Basin with Shelf (Right Hand)

No taphole 665305W
1 taphole 665315W

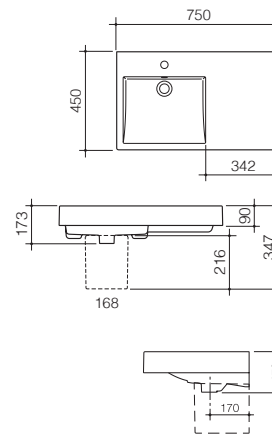

Liano Nexus 750 Wall Basin with Shelf (Right Hand)

No taphole 665405W
1 taphole 665415W

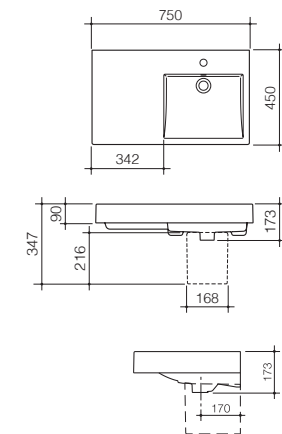

Liano Nexus 750 Wall Basin with Shelf (Left Hand)

No taphole 665505W
1 taphole 665515W

Basins

ABOVE COUNTER BASINS

Above counter basins are installed directly on top of a vanity with minimal installation requirements.

INSET BASINS

Inset basins are partially set into a vanity reducing the appearance of the basin rim without reducing the depth of the bowl.

SEMI RECESSED BASINS

Semi recessed basins partially overhang the vanity allowing you to maximise your basin size on applications with limited vanity space.

UNDER COUNTER BASINS

Under counter basins are installed directly below the vanity top with no visible basin rim.



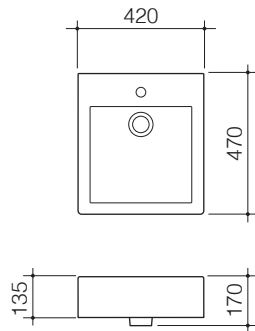

Liano Semi Recessed Basin

No taphole 661205W
1 taphole 661215W



Liano Undercounter Basin

664205W

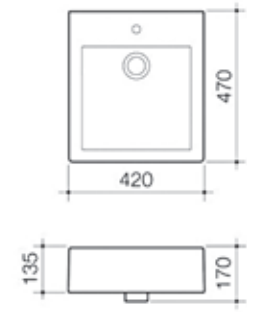

Liano Above Counter Basin

No taphole 664405W
1 taphole 664415W

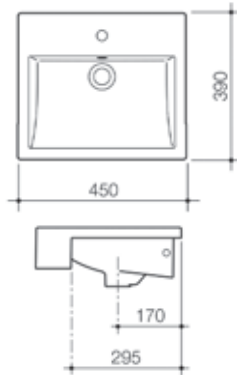

Liano Nexus Inset Basin

1 taphole 665215W

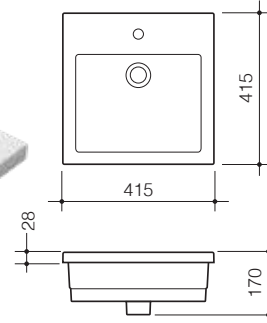

Liano Vanity Basin

1 taphole 664715W

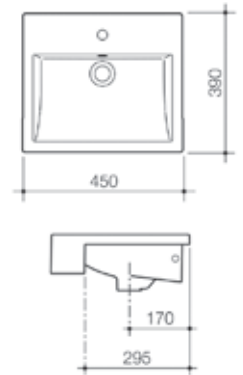

Liano Nexus Semi Recessed Basin

No taphole 665705W
1 taphole 665715W



Showers

Stylish and sophisticated in design, our Liano Collection showers offer a range of different styles, allowing you to create your desired showering experience.

- Available in polished chrome or matte black finish
- Multifunction rail shower has integrated diverter for seamless transition between hand and overhead showers
- WELS 3 star rated, 9L/min
- 10 year warranty

HAND SHOWER

Hand showers give you a great range of flexibility. They allow you to direct the spray wherever you like, whether you want to keep your hair dry or assist with the cleaning.

RAIL SHOWER

Extremely practical, rail showers allow you to vary the height of the shower head along the rail and at different angles.

Our Liano Nexus multifunctional rail shower features include 3-spray functionality for a personalised showering experience.

RAIN SHOWER

Positioned directly overhead these provide a “rain like” immersive showering experience with maximum body coverage.

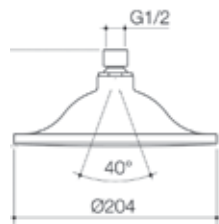

Liano Nexus Overhead Rain Shower

WELS 3 star rated, 9L/min
 Chrome 91051C3A
 Black 91051B3A

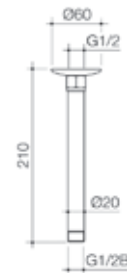

Liano Nexus Ceiling Shower Arm

Chrome 2465.04
 Black 2465.04B



Liano Nexus Right Angle Shower Arm

Chrome 2464.04
 Black 2464.04B

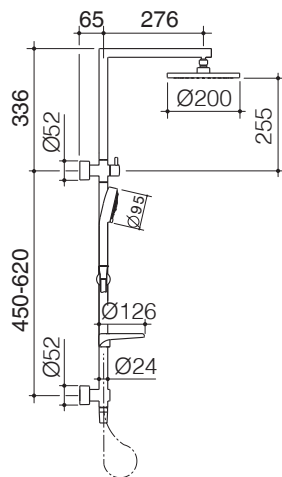

Liano Nexus Multifunction Rail Shower with Overhead

WELS 3 star rated, 9L/min
 Chrome 91056C3A
 Black 91056B3A

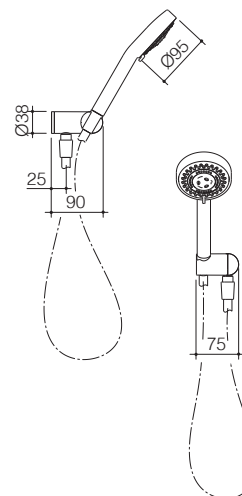

Liano Multifunctional Hand Shower

WELS 3 star rated, 9L/min
 Chrome 91059C3A
 Black 91059B3A

Baths

The Liano Collection has been designed for those who favour a minimalist square style. With a focus on comfort the range offers multiple sizes and installation types.

- Crafted from sanitary grade acrylic – resists chipping and has excellent heat retention qualities
- Suitable for freestanding, back to wall or corner placement
- Plug and waste options available
- 10 year warranty

FREESTANDING BATH

The Freestanding tub has become a real statement piece in bathrooms in recent years. Because of their all-sided finish, they can be placed anywhere – even in the center of the bathroom. They are available in a range of sizes, and if you have a smaller bathroom, the Liano 1400 is ideal for compact spaces, whilst still achieving a freestanding look.

The Liano 1525 and 1675 bath sizes feature dual reclined ends and a centre waste position for comfort.



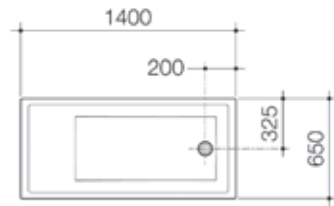

Liano 1400 Freestanding Bath

1400mm (l) x 650mm (w) x 440mm (d)
LN4WFW

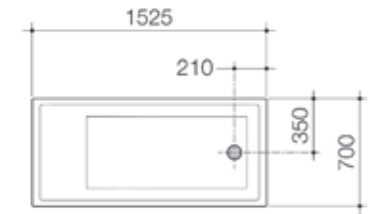

Liano 1525 Freestanding Bath

1525mm (l) x 700mm (w) x 440mm (d)
LN5WFW

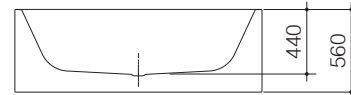
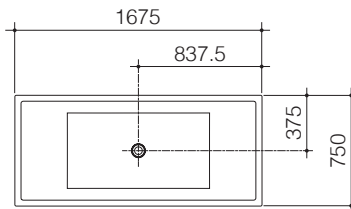

Liano 1675 Freestanding Bath

1675mm (l) x 750mm (w) x 440mm (d)
LN7WFW



40mm Pop-up Plug & Waste

Chrome 323060C



40mm Plug & Waste

White 323060W



Tapware

Make a bold statement in your bathroom with the Liano Collection's expressive range of fashionable stylish polished chrome tapware.

Our Liano tapware features a slimline paddle handle, creating a contemporary look and feel.

- Designed and engineered in Australia
- High quality solid brass construction
- Mixers feature Ultraflex PEX hoses which provide superior durability and cleanliness while the easy clean silicone aerator prevents limescale build up
- WELS 5 star rated, 6L/min
- 10 year warranty

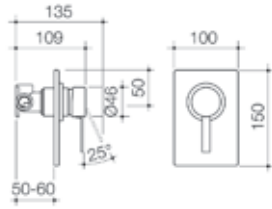

Liano Bath/Shower Mixer with Diverter

96146C

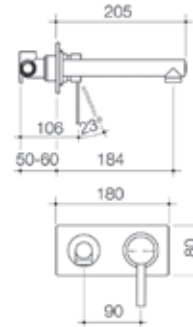

Liano Wall Basin Mixer

WELS 5 star rated, 6L/min
Chrome 96183C5A

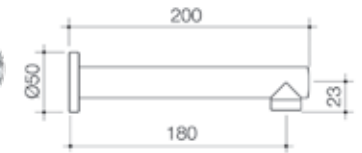

Liano Wall Basin Outlet

WELS 5 star rated, 6L/min
Chrome 96154C5A

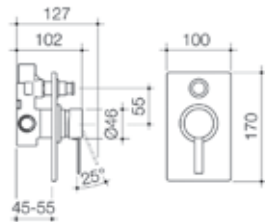

Liano Bath/Shower Mixer with Diverter

96146C

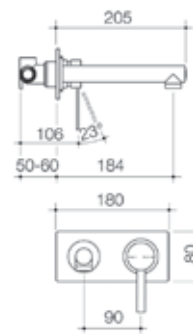

Liano Wall Bath Mixer

Chrome 96183C

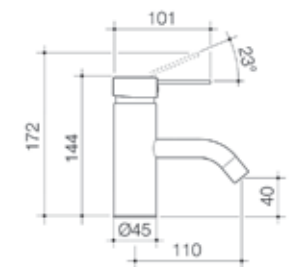

Liano Basin Mixer

WELS 5 star rated, 6L/min
WELS 6 star rated, 4.5L/min

Chrome 96142C5A
Chrome 96142C6A

Tapware

Following the latest interior design trends, the distinct finishes of the Liano Nexus tapware will enhance the look of your bathroom, featuring a slimline pin handle that complements the complete Liano collection.

- Designed and engineered in Australia
- High quality solid brass construction
- Available in matte black or polished chrome finish
- Mixers feature Ultraflex PEX hoses which provide superior durability and cleanliness while the easy clean silicone aerator prevents limescale build up
- WELS 5 star rated, 6L/min
- 10 year warranty



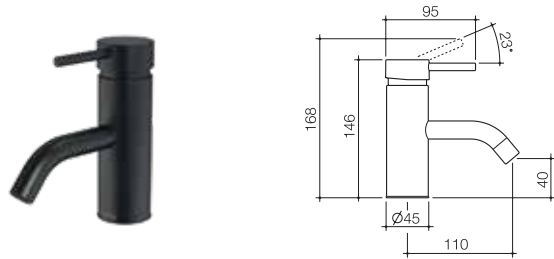

Liano Nexus Basin Mixer

WELS 5 star rated, 6L/min
 Chrome 96193C6A
 Black 96193B6A

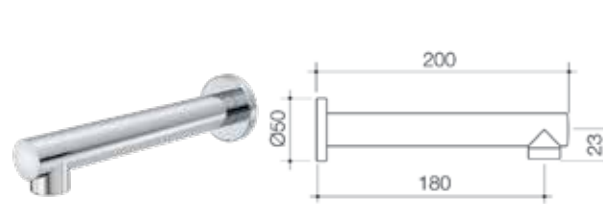

Liano Nexus Bath Outlet Straight

Chrome 96154C
 Black 96154B

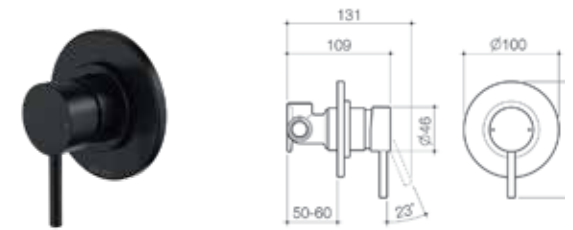

Liano Nexus Bath/Shower Mixer

Chrome 96130C
 Black 96130B

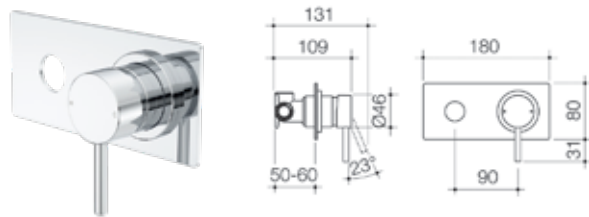

**Liano Nexus Wall Basin/Bath Mixer
 Platemount Kit - No Outlet**

Chrome 96164C
 Black 96164B

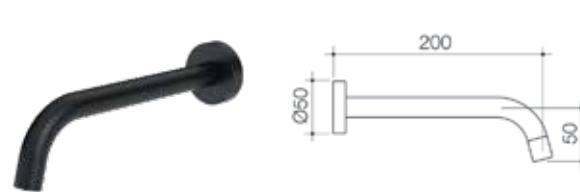

Liano Nexus Angled Wall Basin/Bath Outlet

WELS 5 star rated, 6L/min
 Chrome 96161C5A
 Black 96161B5A



FLOW SPLITTER
Powerful flush for whole bowl clean



FLOW CHANNELS
Controlled water flow eliminates splash back



FLOW BALANCER
Precise flush stream effectively clears the bowl

Toilet suites

Caroma Cleanflush® is our most effective and hygienic toilet. Our patented design features revolutionary rimless technology that delivers the next generation of toilets: easy to clean and water efficient with superior hygiene.

- Designed and engineered in Australia
- Available in wall faced or wall hung styles. Wall faced options include Caroma's patented Uni-Orbital® connector for ease of installation
- Invisi Series II® buttons sold separately. Available in a range of colours and finishes to suit your individual style
- WELS 4 star rated, 4.5/3L (3.5L avg/flush)
- Signature slimline, soft close seat
- 10 year warranty

INVISI WALL FACED TOILET SUITES (BEHIND THE WALL/CONCEALED)

The toilet pan sits on the floor and is connected to a cistern concealed inside the wall cavity, ceiling or under counter.

INVISI WALL HUNG TOILET SUITES (BEHIND THE WALL/CONCEALED)

The toilet pan sits off the floor and is mounted directly to the wall and connected to a cistern concealed inside the wall cavity, ceiling or under counter.

WALL FACED TOILET SUITE

The toilet pan sits flush to the wall with the cistern mounted directly on top.



**Liano Cleanflush® Wall Hung
Invisi Series II® Toilet Suite**

WELS 4 star rated, 4.5/3L (3.5L avg/flush)
 ID, IC, IW 766910W
 UC 766920W
 SBW 766930W

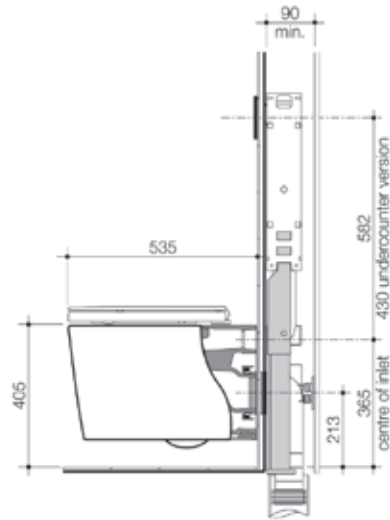

Buttons sold separately



**Liano Cleanflush® Invisi Series II®
Easy Height Toilet Suite**

WELS 4 star rated, 4.5/3L (3.5L avg/flush)
 766350W

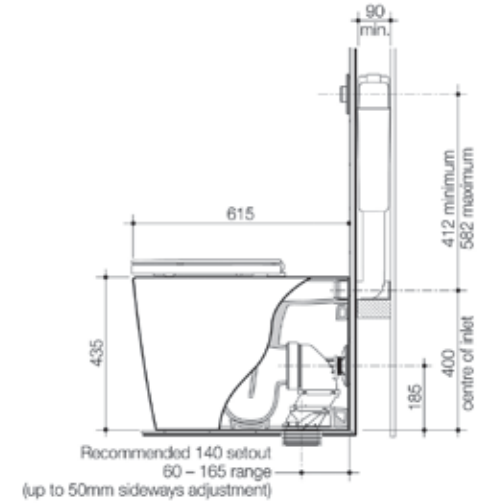

Buttons sold separately



**Liano Cleanflush® Easy Height
Wall Faced Toilet Suite**

WELS 4 star rated, 4.5/3L (3.5L avg/flush)
 766450W

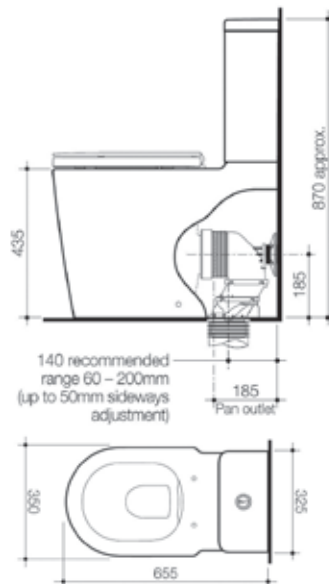

**Liano Wall Faced
C/C BE Suite**

WELS 4 star rated, 4.5/3L (3.5L avg/flush)
 766200W

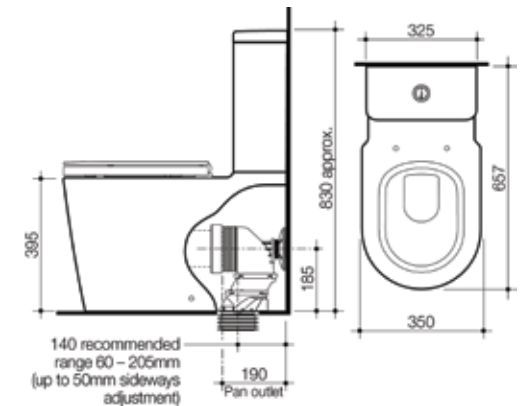



Accessories

Our Liano range of accessories complement the design of the rest of the collection and will ensure your bathroom is efficiently organised.

- Durable solid metal construction
- Available in polished chrome or matte black finish
- 1 year warranty



**Liano/Liano Nexus
Single Towel Rail**

Chrome 96120C
Black 96120B



**Liano/Liano Nexus
Double Towel Rail**

Chrome 96124C
Black 96124B

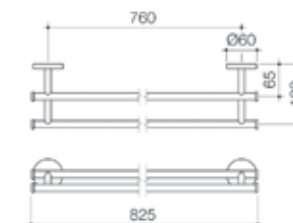

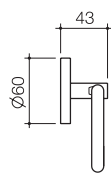
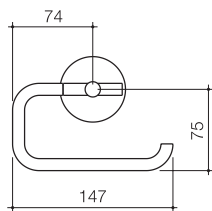

Liano/Liano Nexus Toilet Roll Holder

Chrome 96124C
Black 96124B

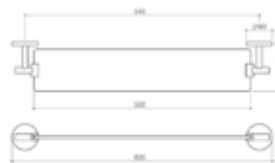

Liano Nexus Glass Shelf

Black 96127B

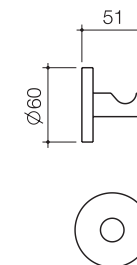

Liano/Liano Nexus Robe Hook

Chrome 96125C
Black 96125B

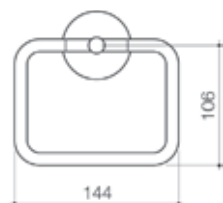

Liano/Liano Nexus Hand Towel Ring

Chrome 96122C
Black 96122B

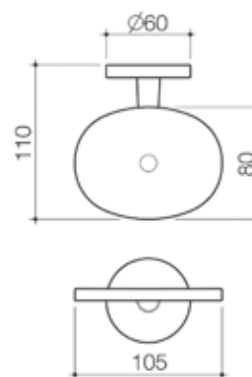

Liano Nexus Soap Dish

Black 96126B







With over 75 years of experience, we believe quality bathrooms are a balance of form, function and looks. Our designs and innovation bring to life a guiding vision of creating sustainable luxury. Design that enables you to enjoy bathroom experiences that both complement and elevate your lifestyle, from an energising morning start to an indulgent, relaxing moment of luxury, all underpinned by sustainability.

Designing for Australians and New Zealanders, from all walks of life, with different tastes and needs; we have a wide range of classic to artisanal styles, smart designs and sustainable innovations providing you with everything you need to create the *sanctuary of your dreams.*

www.caroma.co.nz

© Copyright 2019. Caroma Industries Ltd. ABN 35 000 189 499. All rights reserved. Material and design specifications subject to change without notice. Product colour reproduction is as near to actual product colour as production methods allow. Warning: Products in this brochure are the subject of registered designs and patents. ® is a registered trademark of Caroma Industries. This brochure relates to Australian products only and some product, design or specifications may differ in other countries.



CONTURA

BATHROOM COLLECTION





Caroma Vogue Collection represents the best of Caroma's leadership in bathroom design and is sure to make a statement in any home.

Creating your own home has always been part of the New Zealand dream; the opportunity to design a unique space that both complements and elevates your individual style. The Caroma Vogue Collection will provide you the freedom to create your dream bathroom; one that enables an experience of personal luxury through customising key design elements.

The collection proudly represents fashionable Australasian styles, made from the highest quality materials and incorporates the latest in sustainable innovations.

“Our **Contura** Collection embodies modern Australasian design. Organic lines and statement shapes are the signatures of this designer collection.”



A handwritten signature in black ink, reading 'LDM'.

- Luke Di Michiel,
Caroma Industrial Designer



CONTURA

The Caroma Contura Collection delivers expressive, modern Australasian design to match a range of bathroom styles.

Ideal for those seeking a designer look, the Contura Collection features everything you want to create your dream bathroom sanctuary.











Create your *sanctuary*



①
Contura 1700
Solid Surface
Freestanding Bath
CO7W



②
Contura
Freestanding
Bath Mixer
99603C



④
Contura 530 Solid
Surface Inset Basin
898900W



③
Contura Bath/
Shower Mixer
99585C

⑤
Contura Wall
Basin/Bath Mixer
99587C5A



⑥

Invisi Series II® Round
Dual Flush Plate & Buttons
(Metal)
237088C



⑦

Liano Cleanflush®
Wall Hung
Invisi Series II®
Toilet Suite
766910W



⑧

Liano Nexus
Multifunction
Rail Shower
with Overhead
91056C3A









Basins

Contura's basin range features thin lines and organic forms in varied options to complement any bathroom.

This range of designer basins includes both solid surface and vitreous china options.

- Australian designed and engineered
- Crafted from high quality vitreous china that has great durability, sanitary and stain resistant properties or solid surface which features a matte, stone like finish with non-porous and hygienic properties
- Includes integrated pop-up plug and waste in matching material for a seamless look
- 10 year warranty

INSET BASINS

Inset basins are partially set into a vanity reducing the appearance of the basin rim without reducing the depth of the bowl.

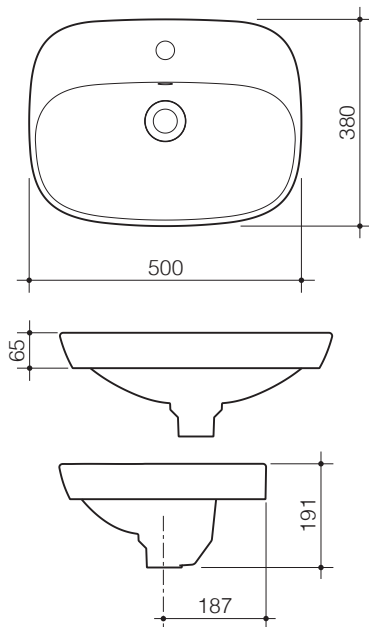

Contura 500 Inset Basin

1 taphole 898715W

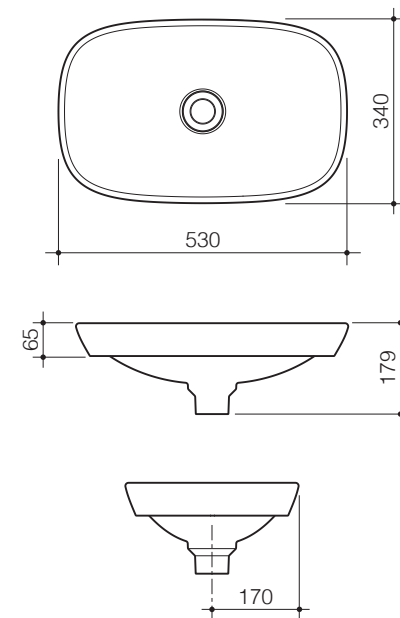

Contura 530 Solid Surface Inset Basin

No taphole 898900W

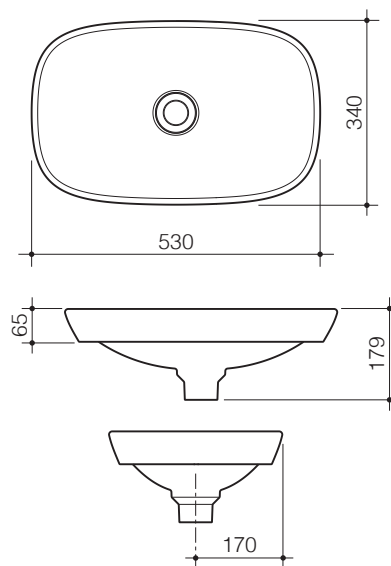

Contura 530 Inset Basin

No taphole 895300W





Baths

The Contura freestanding bath creates a striking focal point in any bathroom. Its generous proportions and designer construction make it ideal for an indulgent and relaxing soak. Dual reclined ends means it is perfect for two.

- Australian designed and engineered
- Crafted from solid surface material for a natural, stone like finish
- Includes integrated pop-up plug and waste in matching material for a seamless look
- 10 year warranty

Contura 1700 Solid Surface Freestanding Bath

Rim thickness: 18mm
CO7W

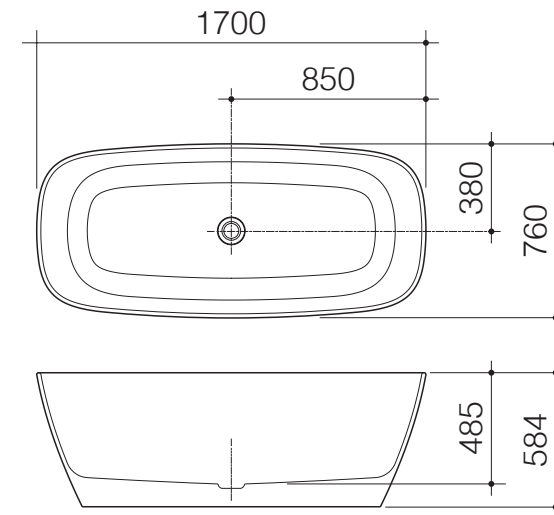



Tapware

Modern and striking, our Contura Collection's range of fashionable matte black or stylish polished chrome tapware will look great in a range of bathroom styles.

- High quality solid brass construction
- Mixers feature Ultraflex PEX hoses which provides superior durability and cleanliness while the easy clean silicone aerator prevents limescale build up
- WELS 5 star rated, 6L/min
- 10 year warranty

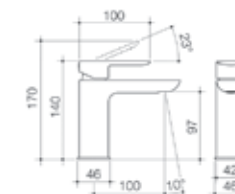

Contura Petite Basin Mixer

WELS 5 star rated, 6L/min
Chrome 99582C5A
Black 99583B5A

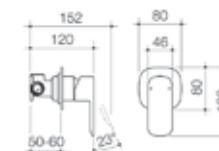

Contura Bath/Shower Mixer

Chrome 99585C
Black 99585B



Contura Basin/Bath Outlet

WELS 5 star rated, 6L/min
 Chrome 99591C5A
 Black 99591B5A



Contura Wall Bath/Basin Mixer

WELS 5 star rated, 6L/min
 Chrome 99587C5A
 Black 99587B5A

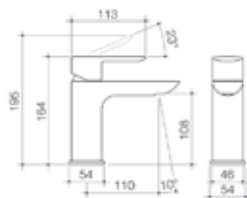

Contura Basin Mixer

WELS 5 star rated, 6L/min
 Chrome 99583C5A
 Black 99583B5A

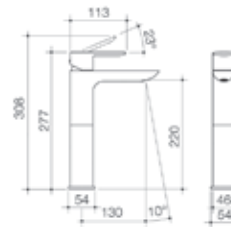

Contura Tower Basin Mixer

WELS 5 star rated, 6L/min
 Chrome 99584C5A
 Black 99584B5A

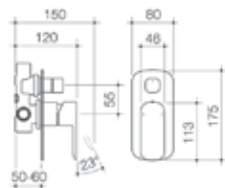

Contura Bath/Shower Mixer with Diverter

Chrome 99586C
 Black 99586B



Contura Freestanding Bath Mixer

Chrome 99603C
 Black 99603B







With over 75 years of experience, we believe quality bathrooms are a balance of form, function and looks. Our designs and innovation bring to life a guiding vision of creating sustainable luxury. Design that enables you to enjoy bathroom experiences that both complement and elevate your lifestyle, from an energising morning start to an indulgent, relaxing moment of luxury, all underpinned by sustainability.

Designing for Australians and New Zealanders, from all walks of life, with different tastes and needs; we have a wide range of classic to artisanal styles, smart designs and sustainable innovations providing you with everything you need to create the *sanctuary of your dreams.*

www.caroma.co.nz

© Copyright 2019. Caroma Industries Ltd. ABN 35 000 189 499. All rights reserved. Material and design specifications subject to change without notice. Product colour reproduction is as near to actual product colour as production methods allow. Warning: Products in this brochure are the subject of registered designs and patents. ® is a registered trademark of Caroma Industries. This brochure relates to Australian products only and some product, design or specifications may differ in other countries.

