

Quicksew
total concept creations

Parklane Interiors
AUSTRALIA



NSWBuy
NSW Procurement

Approved NSWBuy Supplier



ISO Accreditation



PRODUCT FOCUS
EDUCATION FURNITURE 2020

Tables
Modular Furniture
Student Seating
Office Seating

To the Principal...

INTRODUCTION TO QUICKSEW

Established in 1977, Quicksew is the market leader for the supply and installation of window treatments for the Commercial and Domestic markets.

What we do

Quicksew manufactures and supplies products of the highest quality using a wide variety of innovative and stylish fabrics and components to suit any budget or application. We apply extensive industry knowledge to ensure that all our products meet the requirements of our customers and industry standards.

Fit-for-purpose product range

Our range of products include:

- Curtains & Tracks – Blockout And Sheer Curtains
- Blinds – Chain Drive or Motorised Roller Blinds, Vertical Blinds
- Stage Curtains



Approved NSWBuy Supplier



ISO Accreditation

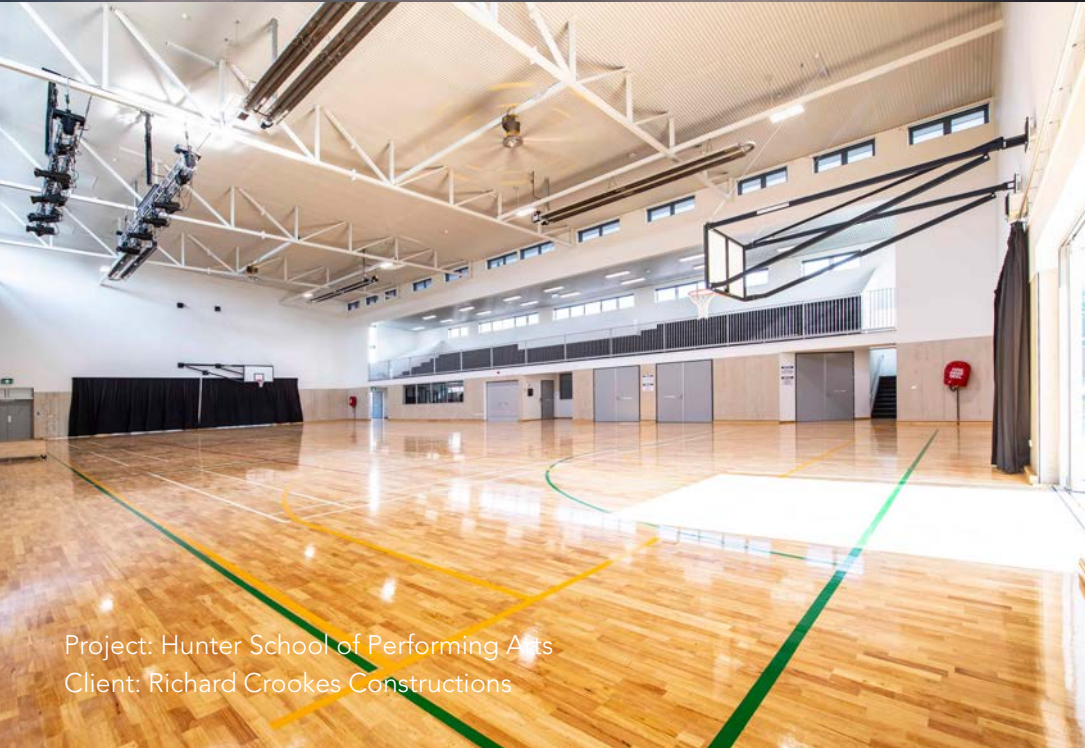

Project: Hunter School of Performing Arts
Client: Richard Crookes Constructions

EDUCATION

COMPANY PROFILE - Education

Quicksew has a proven reputation for the supply of blinds, curtains, stage curtains, drama room curtains, shower curtains, beds and furniture to schools, universities and educational facilities including boarding accommodations.

Quicksew can assist you and your design team with specifications, green star ratings, colour schemes and fabric selections tailored to the project type and budget requirements. We can supply you with resilient, low maintenance products that are fully launderable, comply with fire regulations and create an attractive and practical environment suitable for the specific application.



Project: Ultimo Public School
Client: Hindmarsh Constructions



Project: Hunter School of Performing Arts
Client: Richard Crookes Constructions



Project: St Stanislaus College



Project: St Matthews Catholic School
Client: Farindon Constructions



Project: CSU Orange
Client: Zauner Constructions



Project: Kellyville High School
Client: Richard Crookes Constructions

Our Projects

Abermain Public School	Cowra High School	Ingleburn Library
Albert St Childrens Centre	CSU Allen House	John Edmondson High School
All Saints College	CSU Bathurst	June High School
Anson Street School	CSU Orange	Kandos High School
Argenton Public School	CSU School of Dentistry	Karabar High School
Armidale High	CSU Simulation Clinical School	Kariong High School
Armidale Tafe	CSU Wagga Wagga	Kellyville Senior Campus
Ashton Public School	CSU Winery Upgrade	Kelso High School
Australian Defence Force Academy	Danebank Anglican School for Girls	Kelso Public School
Banora Point High	Hurstville	Kempsey School
Baradine Central School	Denison College	Killara High School
Bates Drive & Wairoa SSP	Denistone East Public School	Kincoppal Girls High School
Bathurst Public School	Dubbo College South	Kincumber Public School
Bathurst TAFE	Dubbo Schools Delroy Campus	Kingswood Tafe
Bega High School	Dubbo Senior Camus	Kinross Walaroi School
Belmont High School	Dubbo Tafe	Lake Cargellico School
Bert Oldfield Public School	Dubbo West Public Schools	Lalor Park Public School
Beverly Hills Girls High School	Dunoon Public School	Lane Cove West Public School
Bingara Gorge School	Duval High School	Leeton High School
Binnaway Central School	East Gosford Public School	Lidcombe TAFE
Blacktown West Public School	East Maitland Public School	Lithgow High School
Blakehurst High	East Orange Public School	Lithgow Public School
Blayney Public School	Edgeworth Public School	Macarthur Anglican School
Bletchington Public School	Eglinton Public School	Macksville School
Blue Mountains Grammar	Elderslie Public School	Macquarie Anglican Grammar School
Bombala School	Endeavour High	Macquarie University
Bonalbo School	Father John Therry School	Manly Vale Public School
Boronia School	Forbes High School	Maroubra Junction Public
Bourke High School	Garvan Institute of Medical Research	Maryland Public School
Bourke Public School	George Bass Public School	Mathew Pearce Public School
Bourke School of Distance Education	Gerrington Public School	Matraville High School
Bourke Tafe	Giralang Primary School	Mayfield West Public
Bowraville School	Glider Training School Bathurst	Meadow Bank Tafe
Broken Hill High School	Gulgong High School	Medowie Christian School
Bulli High School	Hamlyn Terrace Primary School	Merrylands Public School
Callaghan College	Harcourt Public Schools	Middleton School
Canobolas High School	Hay School	Mitchell Early Learning Centre
Canowindra High School	Hennessy Catholic College	Moorebank High School
Carenne School	Henry Lawson High School	Morrissett Hospital
Caroline Chisholm College	Hills Adventist College	Mt Annan High School
Catherine Mcauley Catholic School	Hillston Central School	Mt Druitt Public School
Cedars Christian College	Hilltop School	Mt Druitt Senior Campus
Central Park Student Accommodation	Holgate Public School	Mudgee TAFE
Cheltenham Girls High	Holman Place School	Mullumbimby High School
Clergate School	Holroyd High School	Nambucca School
Cobar Public School	Holy Family Primary School	Narrandera High School
Cooerwull Public School	Holy Parish Prouille School	Narromine High School
Cooma TAFE	Holy Spirit College	Narromine Public School
Coonabarabran High School	Hoxton Park Public School	Nepean High School
Courallie Day Care Centre	Hunter River School	Newcastle TAFE
	Hunter School of Performing Arts	Newington College
	Illawarra Sports High	North Sydney Boys High

North Sydney Tafe	St Edwards Primary	University of NSW
Northern Beaches Christian School	St Finibars Primary School	University of Sydney
Northern Beaches Tafe	St George Christian School	University of Sydney -Camden
Oberon Child Care Centre	St Gregory's College	University of Sydney CODCD (Charles Perkins Centre)
Orana Heights Public School	St Ignatius College	University of Wollongong
Orange Anglican Grammar School	St Justins Catholic Primary School	University of Wollongong Science Teaching
Orange East Public	St Margaret Mary Primary	UNS Kingswood
Orange High School	St Marouns College	UNSW Mary White College
Orange Public School	St Marys Catholic Primary School	Uralla Central School
Orange TAFE	St Matthews Catholic School	USYD Blackburn Building
Our Lady of Annunciation	St Nicholas of Myra Primary	UTS Ultimo
Our Lady of Dolours Primary	St Patricks Primary School	UWS Bankstown Campus
Our Lady of Lourdes	St Phillips Christian College	UWS Bathurst
Our Lady of Mercy	St Philomena School	Wagga Wagga Tafe
Our Lady of Rosary School	St Raphaels Primary School	Wahroonga Adventist School
Oxley Vale School	St Spyridon School	Wallerawang Public School
Padstow TAFE	St Stanislaus College	Wangi Wangi Public School
Parkes School	St Thomas Aquinas School	Waniora School
Parry School	St Thomas Primary School	Waratah College
Peak Hill School	Stella Maris School	Waratah Early Learning Centre
Picnic Point High School	Sydney Missionary Bible College	Warilla North Public
Point Clare Public School	Sydney University	Warren Central School
Poole Rd Special School	Sydney University Library	Wauchope High School
Quandialla Central School	Sydney University Medical Education Centre	Waverly Early Learning Centre
Queanbeyan Tafe	Sylvania School	West Bathurst Public
Raglan Public School	The Assumption School	West Wallsend Public School
Ravenswood School for Girls	The Kings School	West Wyalong High
Redbend College	The Ponds School	Westfield Sports High
Richmond Tafe	Trunkey Creek School	Weston Public School
Riverina Anglican College	Truscott St Public School	Wilcannia Central School
Ropes Crossing Public School	Tullimbar Park Primary School	Willoughby Girls High School
Rouse Hill Anglican School	Tumbarumba High School	Willoughby Public School
San Clemente School	Tumut Public School	Wingham School
Sancta Sophia College	Tweed Heads High	Wollongong Tafe
Second Ponds Public School	Ulladulla High School	Wollumbin School
Shellharbour Anglican Grammar	UNI of NSW Kensington Colleges	Woodenbong School
Southern Lachlan TTC	Uni of Sydney Marsden Building	
Speers Point School	University Of New England	
St Andrews Public School	University of Newcastle	
St Charbels College		

CONTENTS

The Quicksew eQuote System	Page 8
ISO Accreditation	Page 9

TABLES

DESIGN YOUR OWN TABLE	Page 12
Quadrant	Page 14
Pentagon	Page 18
Modular	Page 20
Flag	Page 22
Tripod	Page 24
Zampa	Page 25
Round	Page 26
Spade	Page 27
Stingray	Page 28
Truss	Page 29
Apple	Page 30
Eclipse	Page 31
Axe/Bone	Page 32
Star	Page 33
Crescent/Segment	Page 34
Teknik	Page 35
Student	Page 36
Transit	Page 37
Extra	Page 38

SEATING

Ottoman	Page 40
Swift	Page 41
Shell/Anne	Page 42
Edutech	Page 43
Multi-purpose	Page 44
Lecture	Page 45
Lab	Page 46
Executive	Page 47
BENCHES & OTTOMANS	Page 48
BANQUETTE SEATING	Page 53

BLINDS & STAGE CURTAINS

BLINDS & BLIND FABRICS	Page 54
STAGE CURTAINS	Page 58

Quicksew

total concept creations

Parklane Interiors
AUSTRALIA



eQuote

SYSTEM

Online Product Quoting Tool



NSWBuy
NSW Procurement

Approved NSWBuy Supplier

HOW IT WORKS...

Streamline your quote requests with Quicksew



1

Go to our website www.quicksew.com.au, select "Commercial" and browse our extensive range of products from the dropdown menu.

2

Make your selection, choose a quantity and select "Add to quote" You can then add other products to your quote as required.

3

Simply select the "View eQuotes" button at the top of the page, fill in your details along with any other relevant information and click "Send Your Request" It is that simple!

You will receive a confirmation email with the quote details and our team will be in touch to discuss options and pricing.

Need to know more?
Call our experienced team on 1800 065 068

eQuote

SYSTEM

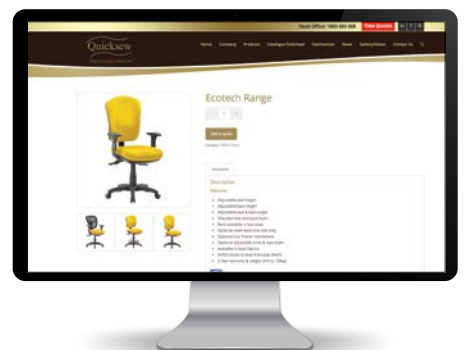

eQuote - Easy Online
Quoting Tool

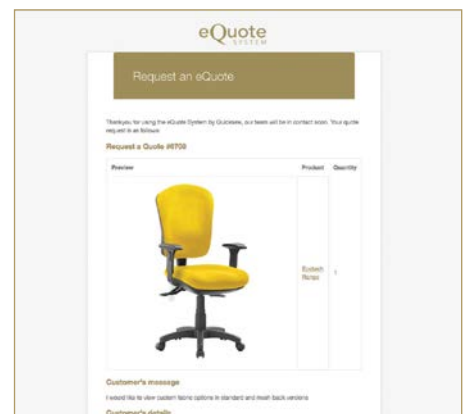

Example eQuote email

ISO ACCREDITATION



Quicksew Pty Ltd

Best Practice Certification Pty Ltd has assessed the above company as complying with the following management system standard requirements at the address shown.

Standard:	ISO 9001:2015 Quality Management System Requirements		
Scope of Certification:	Quicksew is a manufacturer and installer of bespoke residential and commercial window furnishings (i.e. roller blinds, venetian blinds and curtains). Quicksew is a supplier of fit for purpose fixed furniture/fittings and equipment (FFE) including fabrics, curtains, blinds, artwork, bedspreads, shower curtains, privacy curtains and accessories to aged care facilities, hospitals, commercial buildings, schools and higher education facilities, motels, apartments and residential projects.		
Head Office Address:	16, Bradwardine Rd, Bathurst, NSW 2795, Australia		
Initial Certification Date:	09/10/2019		
Issue Date:	Expiry Date:	Certificate Number:	
11/10/2019	09/10/2022*	63087618639Q	



CERTIFICATION APPROVED:

Kobi Simmat
Managing Director
Best Practice Certification Pty Ltd

**BESTPRACTICE
CERTIFICATION**



a» Suite 2, Level 2, Building B
122-126 Old Pittwater Road
Brookvale NSW 2100
p» 1300 402 602
w» <https://bestpracticecertification.com.au>



www.jas-anz.org/register

JAS-ANZ



* Subject to regular surveillance audits

ISO ACCREDITATION



Quicksew Pty Ltd

Best Practice Certification Pty Ltd has assessed the above company as complying with the following management system standard requirements at the address shown.

Standard:	ISO 14001:2015 Environmental Management System Requirements		
Scope of Certification:	Quicksew is a manufacturer and installer of bespoke residential and commercial window furnishings (i.e. roller blinds, venetian blinds and curtains). Quicksew is a supplier of fit for purpose fixed furniture/fittings and equipment (FFE) including fabrics, curtains, blinds, artwork, bedspreads, shower curtains, privacy curtains and accessories to aged care facilities, hospitals, commercial buildings, schools and higher education facilities, motels, apartments and residential projects.		
Head Office Address:	16, Bradwardine Rd, Bathurst, NSW 2795, Australia		
Initial Certification Date:	09/10/2019		
Issue Date:	Expiry Date:	Certificate Number:	
11/10/2019	09/10/2022*	63087618639E	



CERTIFICATION APPROVED:

Kobi Simmat
Managing Director
Best Practice Certification Pty Ltd



JAS-ANZ



www.jas-anz.org/register



a» Suite 2, Level 2, Building B
122-126 Old Pittwater Road
Brookvale NSW 2100
p» 1300 402 602
w» <https://bestpracticecertification.com.au>

* Subject to regular surveillance audits

ISO ACCREDITATION



Quicksew Pty Ltd

Best Practice Certification Pty Ltd has assessed the above company as complying with the following management system standard requirements at the address shown.

Standard:	AS/NZS 4801:2001 OH&S Management System Requirements		
Scope of Certification:	Quicksew is a manufacturer and installer of bespoke residential and commercial window furnishings (i.e. roller blinds, venetian blinds and curtains). Quicksew is a supplier of fit for purpose fixed furniture/fittings and equipment (FFE) including fabrics, curtains, blinds, artwork, bedspreads, shower curtains, privacy curtains and accessories to aged care facilities, hospitals, commercial buildings, schools and higher education facilities, motels, apartments and residential projects.		
Head Office Address:	16, Bradwardine Rd, Bathurst, NSW 2795, Australia		
Initial Certification Date:	09/10/2019		
Issue Date:	Expiry Date:	Certificate Number:	
11/10/2019	09/10/2022*	630876186395	



CERTIFICATION APPROVED:

Kobi Simmat
Managing Director
Best Practice Certification Pty Ltd

**BESTPRACTICE
CERTIFICATION**



JAS-ANZ



www.jas-anz.org/register

- a» Suite 2, Level 2, Building B
122-126 Old Pittwater Road
Brookvale NSW 2100
- p» 1300 402 602
- w» <https://bestpracticecertification.com.au>

* Subject to regular surveillance audits

DESIGN Your Table!

Creating your very own Education Table could not be easier! Our Australian made range is versatile and fully customisable. Our strong and durable table frames are made from fully welded steel tubing and our table tops are constructed from commercial quality melamine board. Not only are our tables built to last and able to withstand the demands of today's collaborative learning environment, they are coupled with a three year warranty for peace of mind.

Choose your SHAPE

All of our ranges are designed to be used seamlessly both individually and alongside other Educational Tables. Pick from over a dozen unique designs that are sure to bring the classroom together!

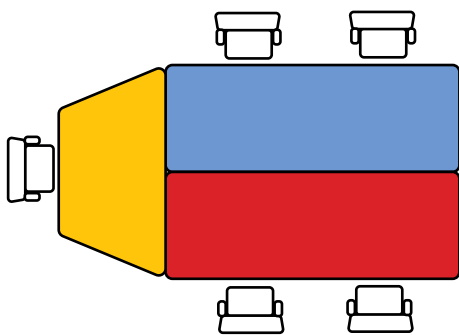

Page 11 - Modular Table Range

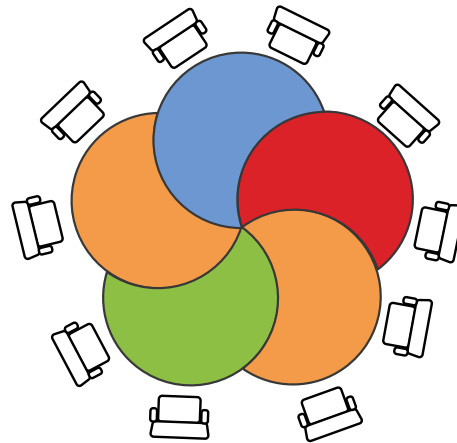

Page 22 - Eclipse Table Range

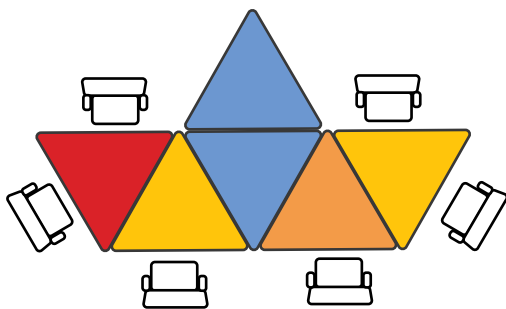

Page 20 - Truss Table Range

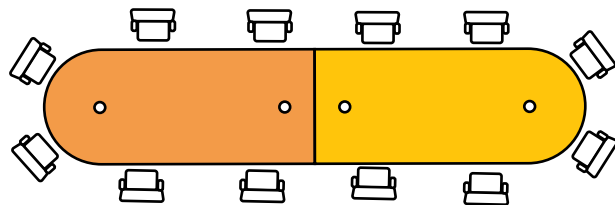

Page 26 - Teknik Table Range

Choose your COLOUR

Choose from a wide variety of tabletop colours from both our Core Colours as well as our Extended Laminex Range! Mix and match your choice with the Frame Colour to create a table that is right for you!

FRAME Colours

Core Colour Range



For Other Colours. Surcharges Apply, POA.

TOP Colours

Core Colour Range



Extended Laminex Colour Range



Price on application

Choose your LEG

Choose fixed or adjustable legs. Add lockable or non-lockable wheels for extra versatility to some or all legs.



Code 50
50mm Dia x 1.6mm RHS



Code 32
31.8mm x 1.6mm RHS



Code 38
38mm Dia x 1.6mm RHS

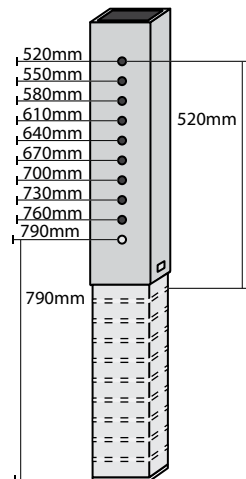

Code 40
Outer: 40mm x 1.6mm SHS
Inner: 36mm x 1.6mm SHS
520 to 790Hmm

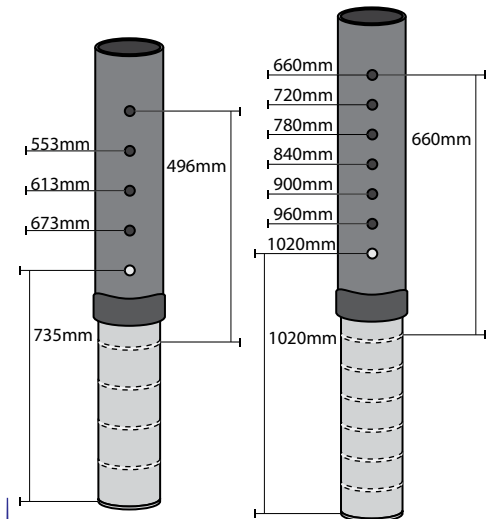

Code 42
Outer: 42mm Dia x 1.6mm RHS
Inner: 38mm Dia x 1.6mm RHS
Table Height 496 to 735Hmm
Counter Height 660mm to 1020mm



Adjustable Feet To Suit Square & Round Legs



Lockable & Non-Lockable Wheels

Available Legs	Leg Code
Round 50mm Non-Adjustable Leg	50
Square 32mm Non-Adjustable Leg	32
Round 38mm Non-Adjustable Leg	38
Square 40mm Pin-Adjustable Leg	40
Round 52mm Pin-Adjustable Leg	42

QUADRANT Table

Quadrant Tables offer a versatile shape, allowing for easy transformation of your space in minutes. The Quadrant range has been designed for durability and flexibility in today's learning environment. The Single Quadrant is designed for classrooms to support a variety of learning and teaching styles on demand. This table shape is dynamic, lending to collaborative learning spaces.

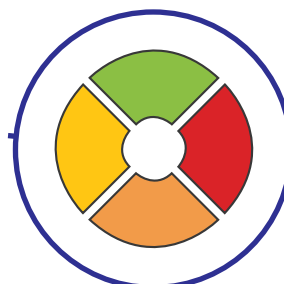

Wide Colour Selection



Smooth Table Edging



Adjustable Feet to Suit Round or Square Legs



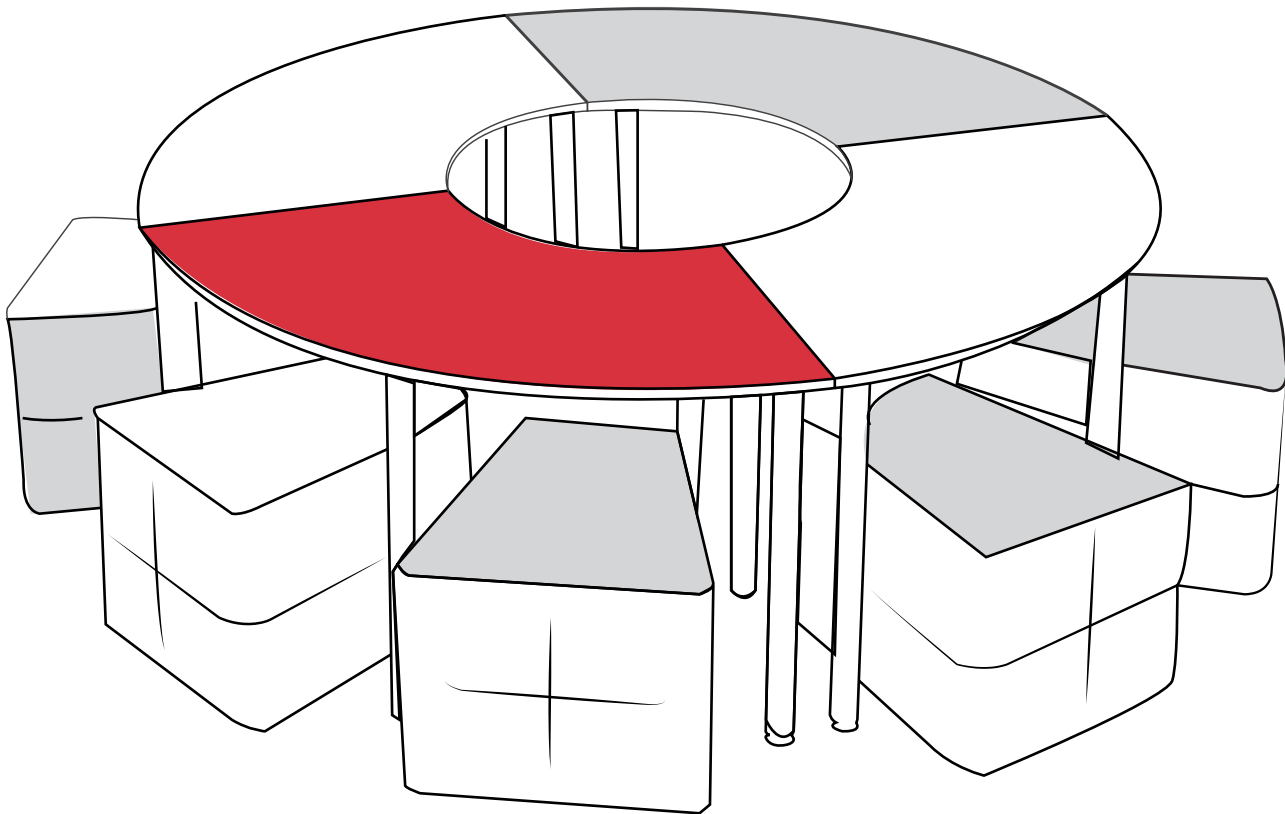

PENTAGON Single



Available Sizes	Code	Leg	Radius	Cutout	Top
900mm Radius	QUA	*	90	25	**
1000mm Radius	QUA	*	10	40	**
1500mm Radius	QUA	*	15	45	**

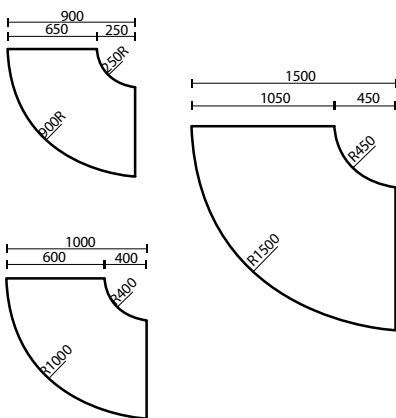

*Available leg codes are explained in detail on Page #4
 **Tops available in 18mm, 25mm or Frame Only options
 All measurements are in millimetres

QUADRANT Dimensions

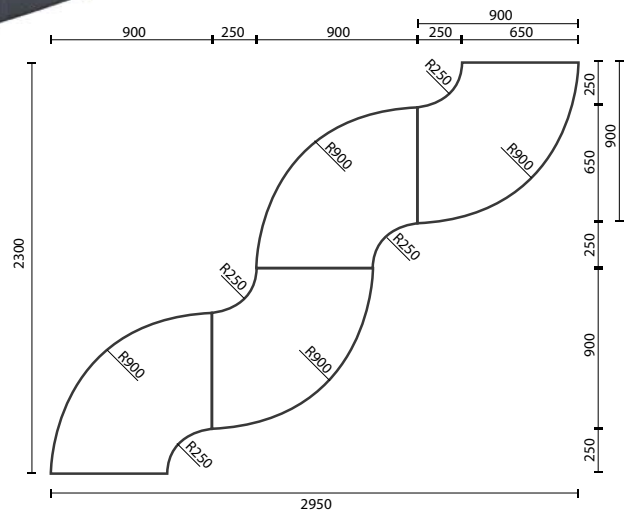

DOUBLE Quadrant

TRIPLE Quadrant

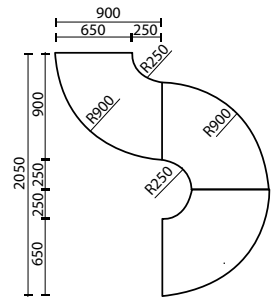
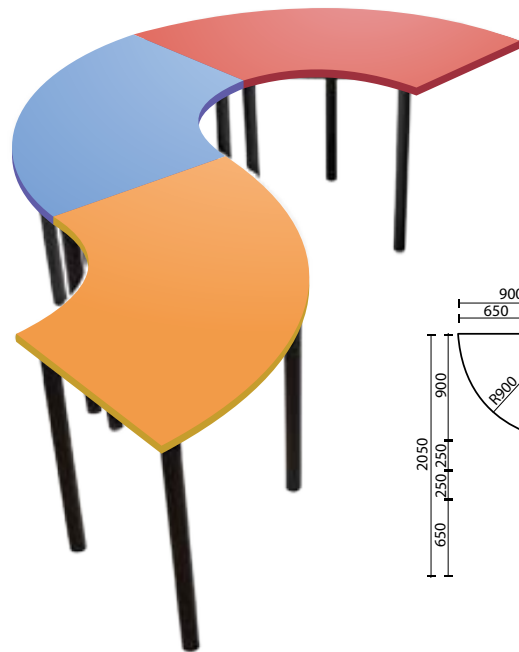
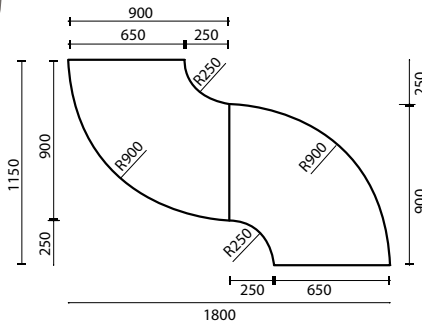

QUADRUPLE Quadrant

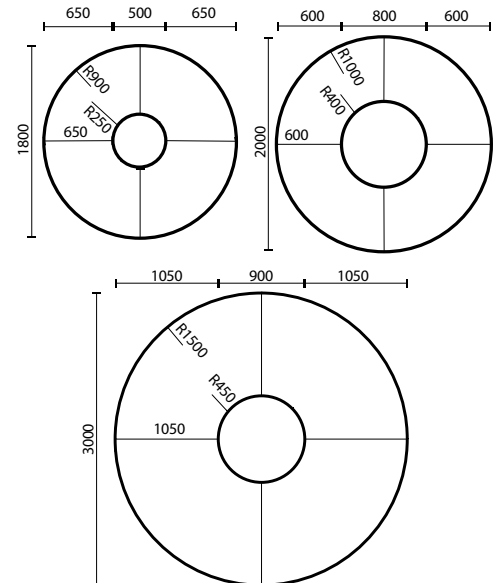

PENTAGON Table

Pentagon Tables are a unique shape within our education table range. Transforming into any number of fun, interesting and usable configurations within seconds. When arranged with other tables from our education range, Pentagon Tables are perfect for crafting a classroom experience that is truly creative.



PENTAGON Twin

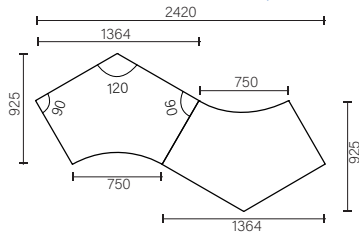
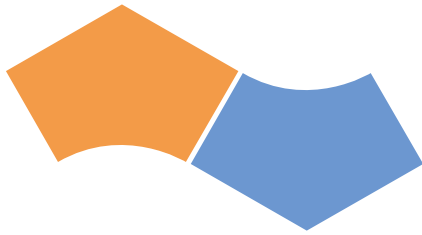

PENTAGON Triplet

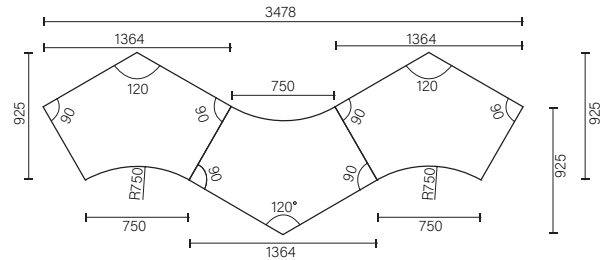
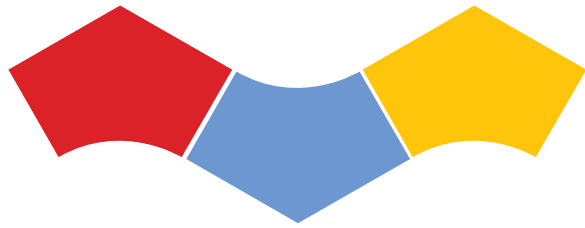

PENTAGON Campfire

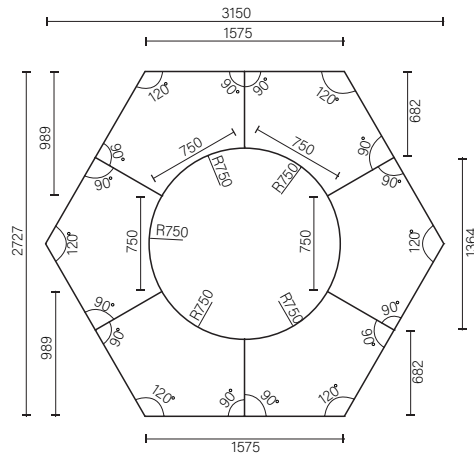

PENTAGON Single

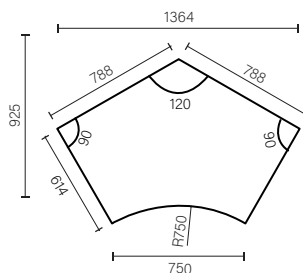

Available Sizes	Code	Leg	Width	Top
1364mm x 925mm	PEN	*	13	**

*Available leg codes are explained in detail on Page #4
 **Tops available in 18mm, 25mm or Frame Only options
 All measurements are in millimetres

MODULAR Table

The Modular Table is a customisable range that can be used to make highly versatile configurations that do not require many specific tables or shapes. By using rectangles, squares and trapeziums, it becomes easy to create many simple, practical configurations for the classroom.



Comes With Adjustable Feet to Ensure Perfect Height

Simple Shapes Endless Configurations!

TRAPEZIUM Table

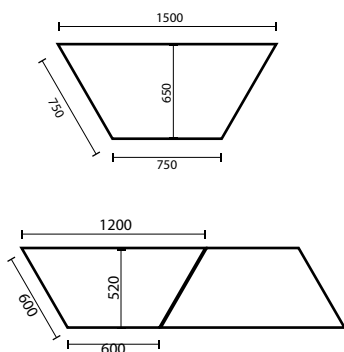

SQUARE Table

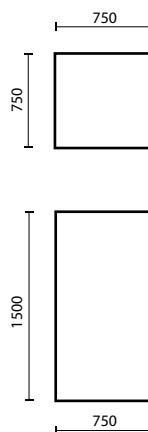

CIRCULAR Table

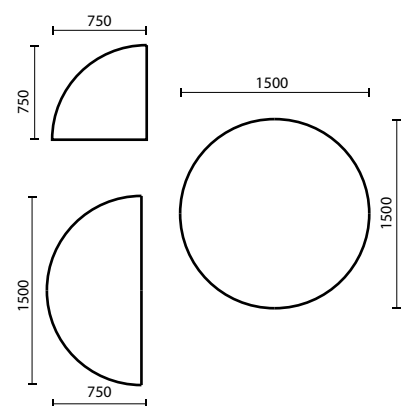

MODULAR Configurations



D - End

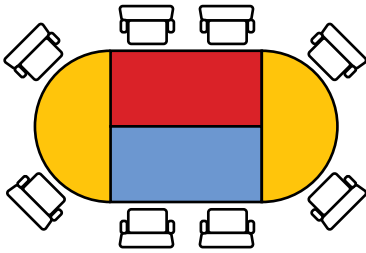

2-Piece CIRCLE

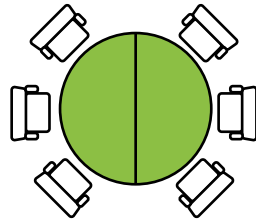

Trapezium TRI

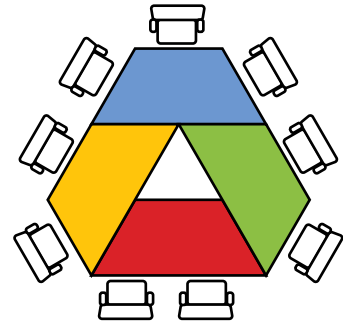

Class RECT

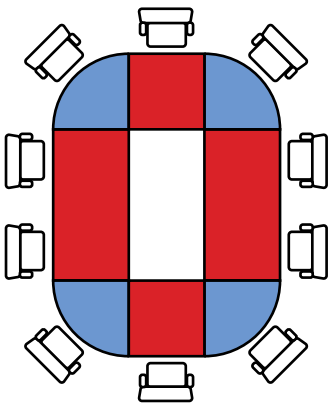

C - Corner

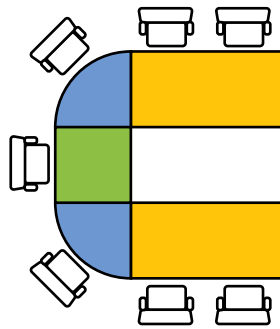

Giant HEX

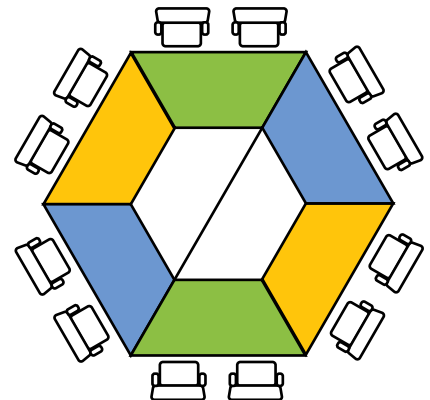

A - Frame

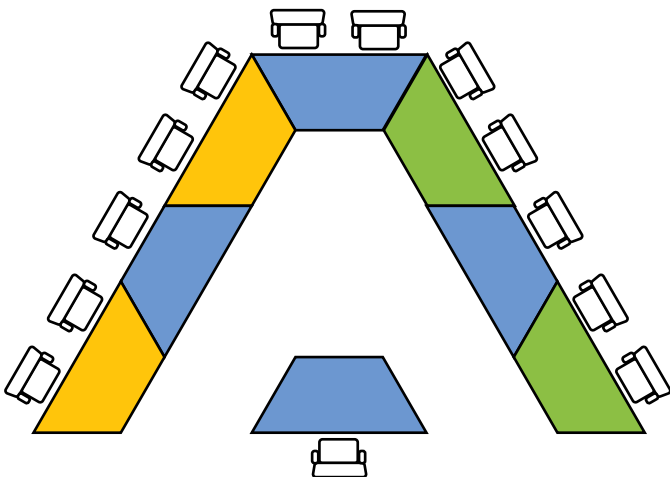

Trapezium DIAMOND

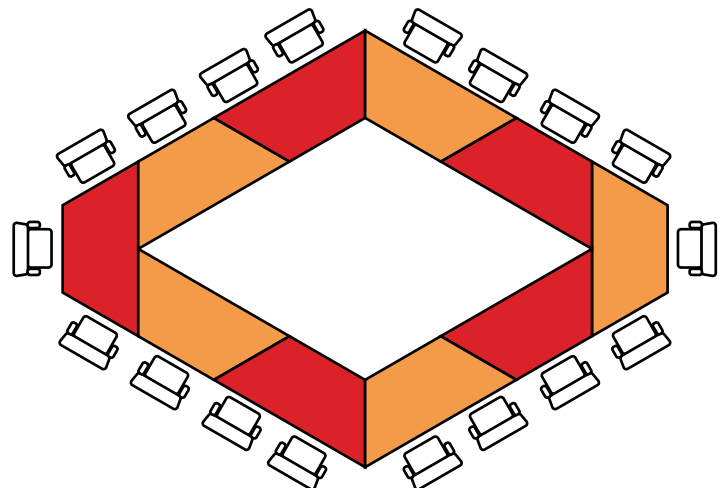

FLAG Table

The Flag Table is an excellent choice for both individual and group use. Stand alone, the Flag creates a unique working environment that inspires creativity and when used in conjunction with other Flag tables, can craft an amazing tessellating array of shapes and colours that lends well to group environments.



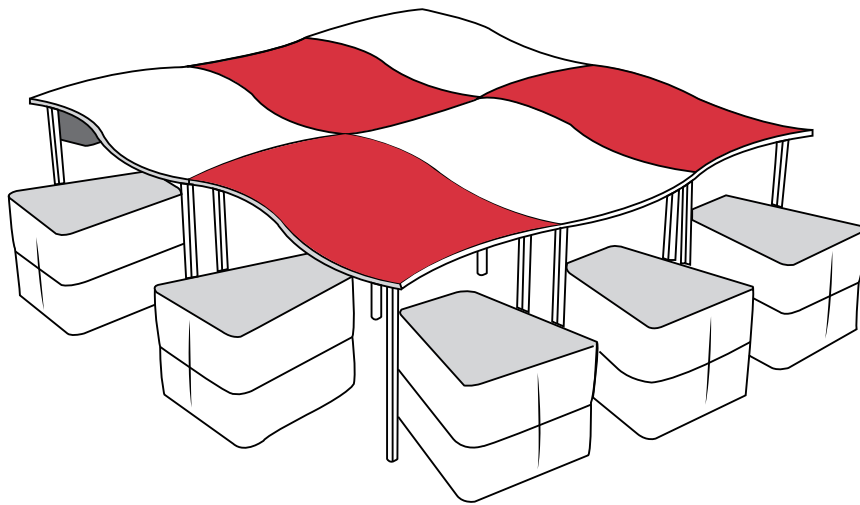

FLAG Quad

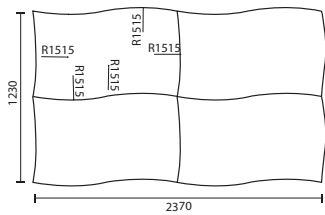

FLAG Banner

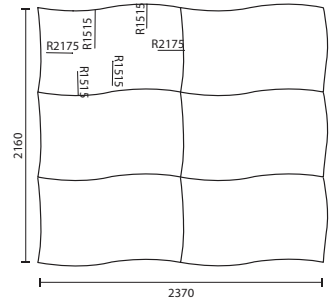
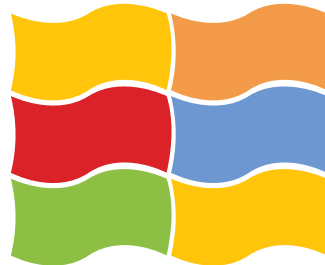

FLAG National

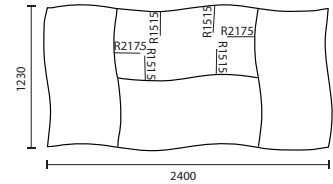

FLAG Single

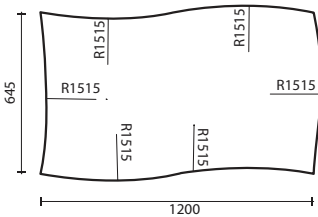

Available Sizes	Code	Leg	Width	Top
1200mm x 645mm	FLA	*	12	**

*Available leg codes are explained in detail on Page #4

**Tops available in 18mm, 25mm or Frame Only options

All measurements are in millimetres

TRIPOD Table

Tripod Tables create a friendly and inviting environment in which to work. With soft edges and seat space for a number of students at one table, the Tripod makes good use of valuable classroom space! The Single Tripod is designed for multiple students to use the table simultaneously. Making it perfect for use in group activity environments as well as dynamic learning settings.



ZAMPA Table

The Zampa table creates a soft edged and open environment in which to work. The shape lends well to collaborative learning with rounded corners for added safety and sense of fluidity in the learning space.



Lockable and Non-Lockable Wheels

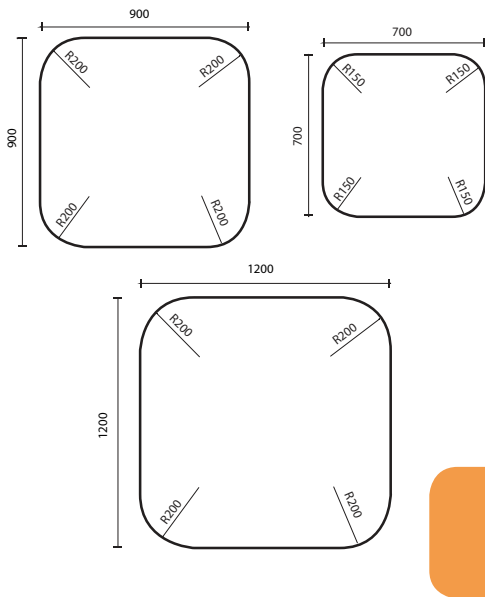

*All measurements are in millimetres

ROUND Table

The Round Table is an essential part of any classroom configuration, with a simple, versatile shape it can be effortlessly utilised with any of our other tables to provide rounded ends or neat centre links between two tables. Like other educational tables, the Round Table can be configured with height adjustable legs, making it compatible with our entire table range!

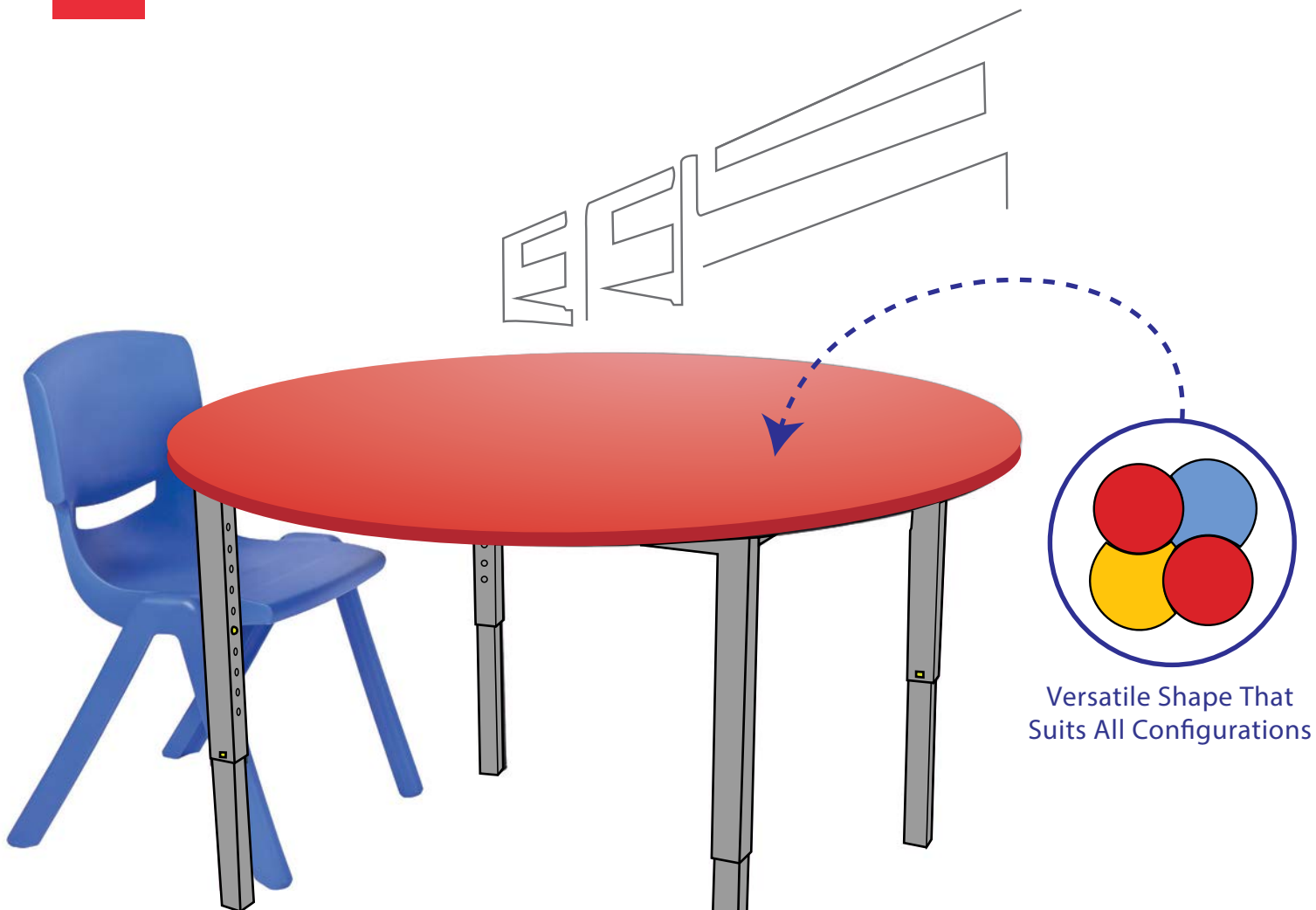

Versatile Shape That Suits All Configurations

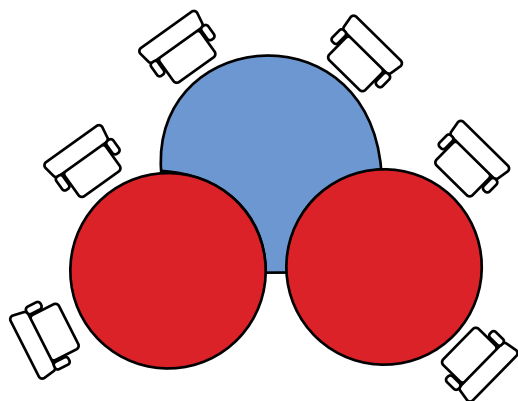

Six Student
Car Configuration
Created with two 1200mm Round Tables
and a single 1200mm Spade Table

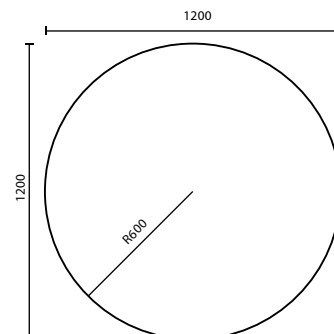

SPADE Table

The Spade Table is a clean way to make seamless corners in groups of tables. The wide end comfortably and safely seats two students while the two concave curves make it a flexible building block with the rest of our range.



Pin Adjustable
Leg Height

*All measurements are in millimetres

STINGRAY Table

Stingray tables make a colourful trio when joined together. Perfect for groups of two students when used alone or six students when joined together, the Stingray is a simple and clean shape with a lot of versatility!

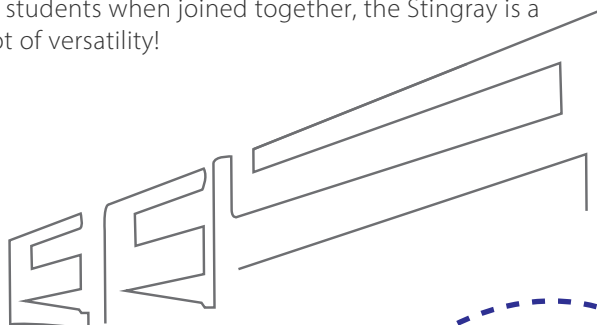

Smooth Edges
Ensure Student Safety

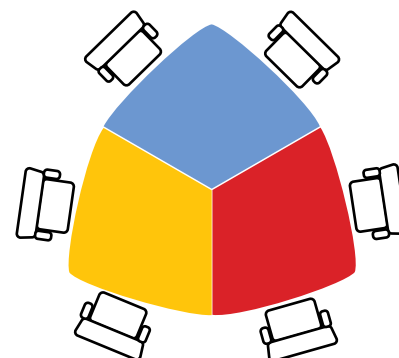
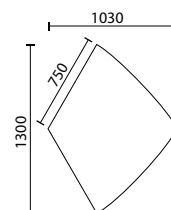

Six Student
Large Stingray Configuration
Created With Three 1300mm 1030mm
Stingray Tables

TRUSS Table

The Truss Table is one of our most flexible tables! Its uniform length means that multiple Truss tables can easily combine together to make any configuration imaginable! Take advantage of the multiple colour options available to create a truly memorable classroom experience.

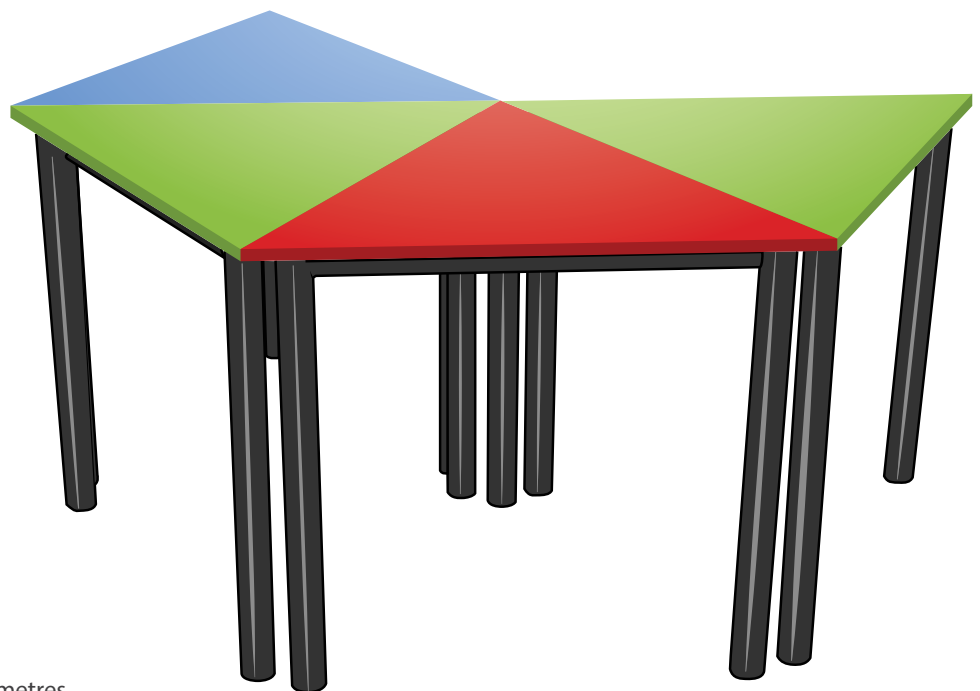
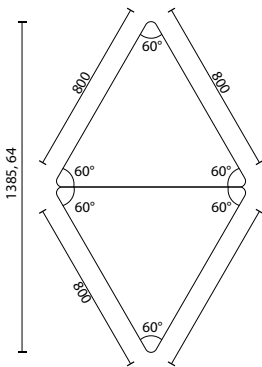
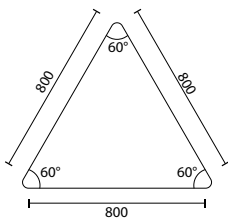
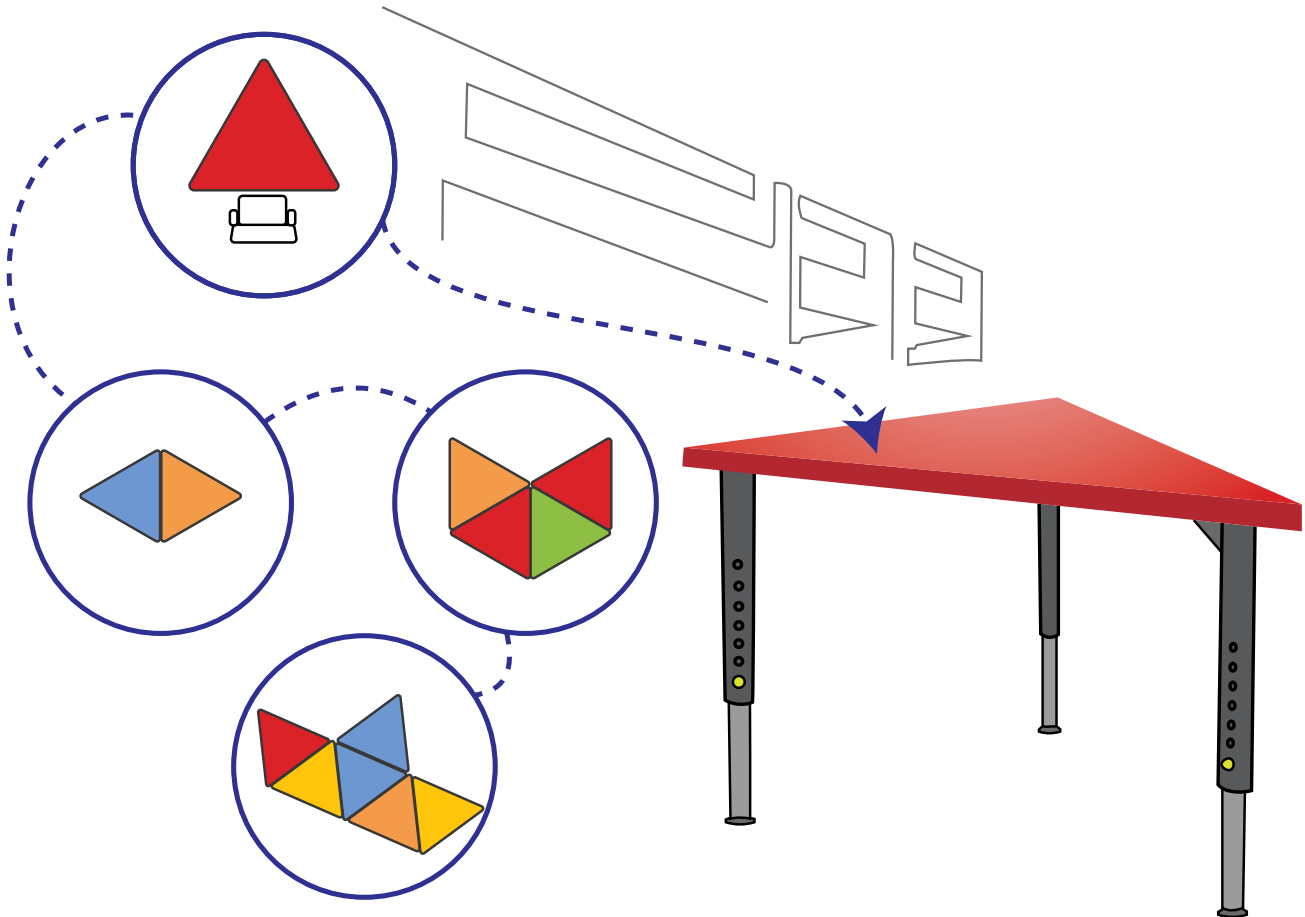

*All measurements are in millimetres

APPLE Table

Apple Tables can be used together as a bright, four-table spiral of colour, or may be used with other tables in the educational range to add a decorative flair to other configurations. Its semi-circular concave side is compatible with our Axe, Bone, Quadrant or Round tables to add a nice, open edge for student groups of two!

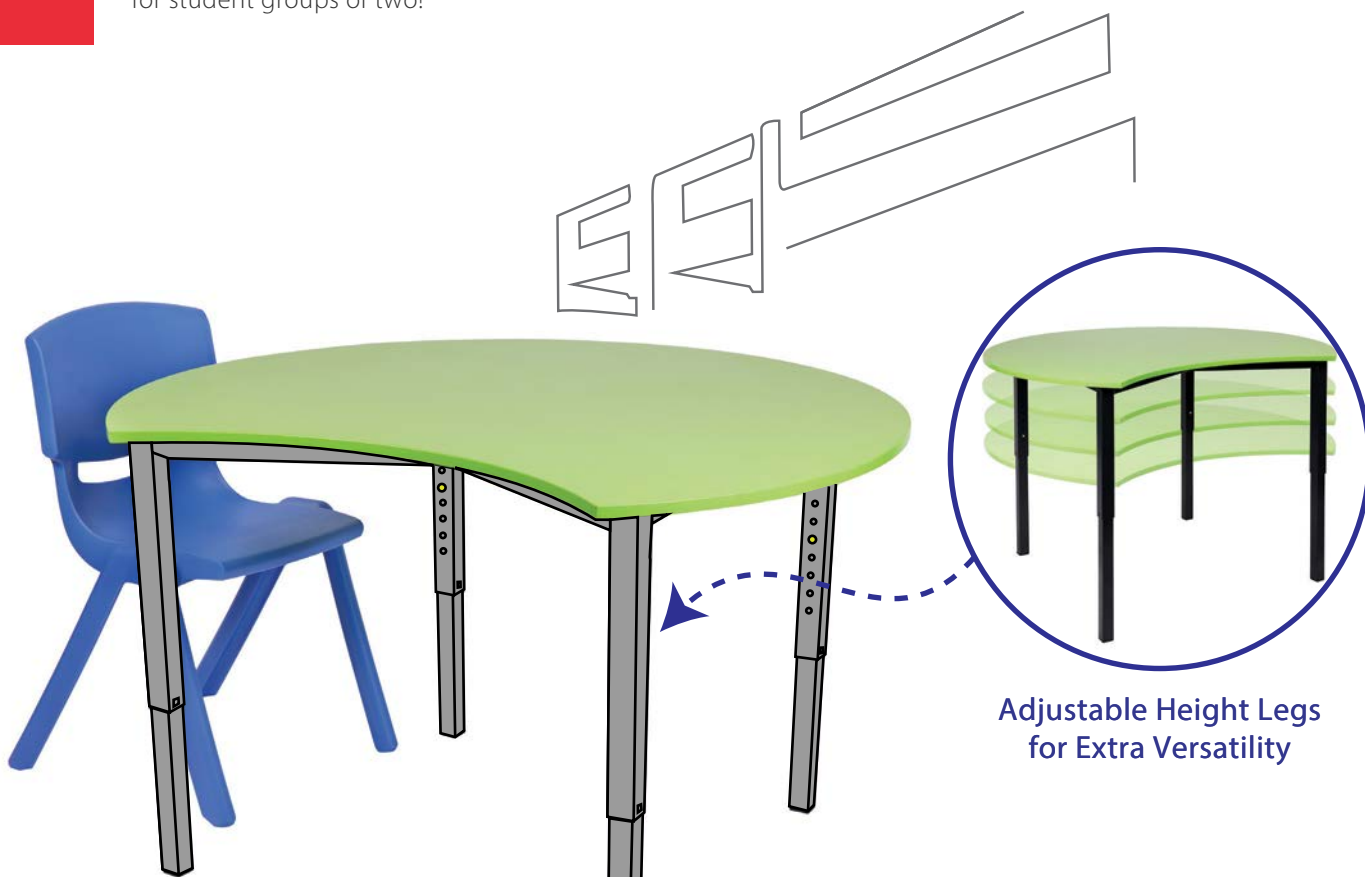

Adjustable Height Legs
for Extra Versatility



Usable With Pedestal Castors
for Easy Movement

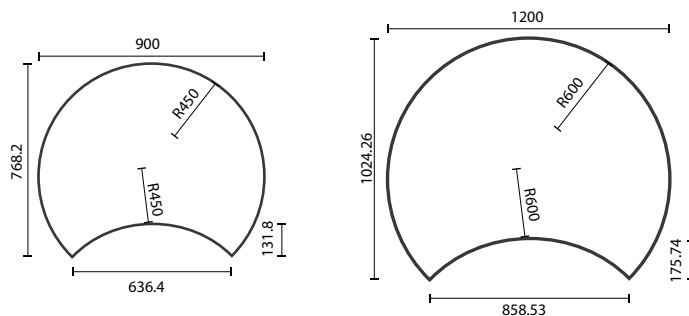

ECLIPSE Table

The Eclipse table is a bold design amongst our educational range, not only does the large, round top provide more than average working space for the creative student. But five eclipse tables can be used together to make a unique spiral of colour, perfect for larger groups of ten or more!

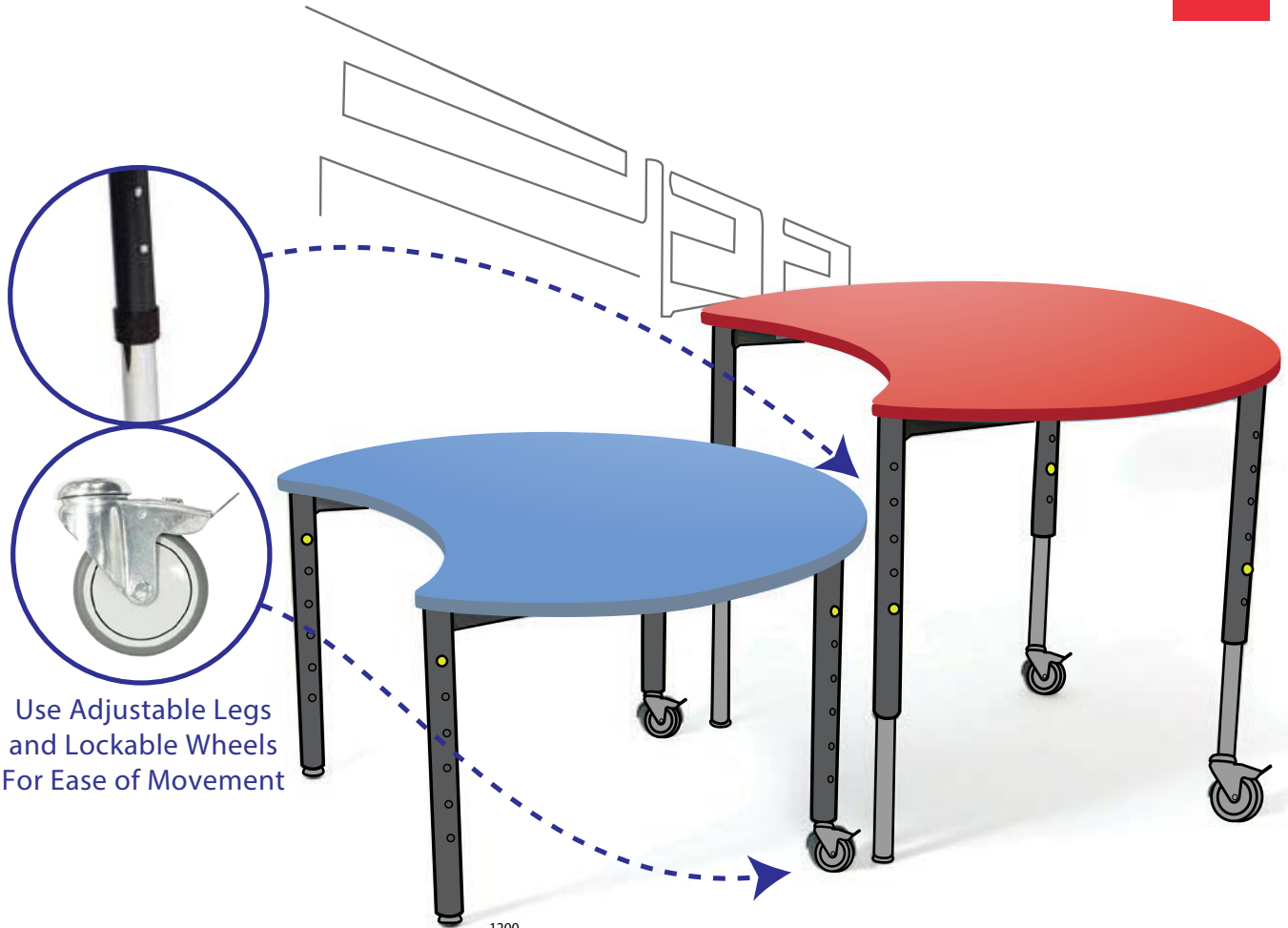

Use Adjustable Legs
and Lockable Wheels
For Ease of Movement

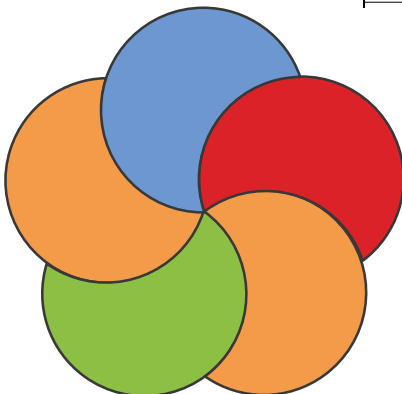
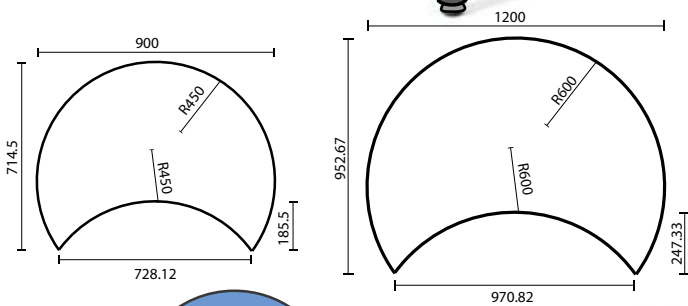

*All measurements are in millimetres

AXE Table

BONE Table

Our Axe and Bone tables really open up the classroom for larger groups. They are perfect linking pieces that can seamlessly join smaller groups of tables into larger classroom configurations for bigger group projects! The curved convex ends of the Axe table make it suitable to connect with Spade, Apple and Star tables while the singular concave end of the Bone makes it easy to use with other Bones or Spheres for a truly skeletal design!

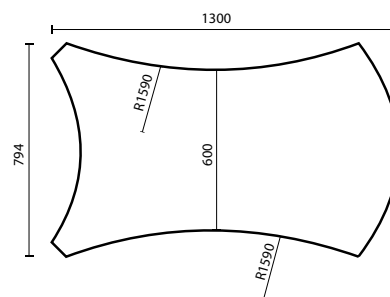
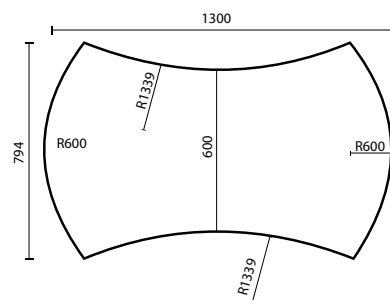

Fourteen Student Classroom Cluster
Created with Axe and Bone tables
in conjunction with Star, Eclipse, Spade and Round

STAR Table

The Star Table is the ultimate centerpiece for our educational range. When used with our other tables, it can be used to create a clean, symmetrical shape that keeps a dynamic learning classroom in balance!

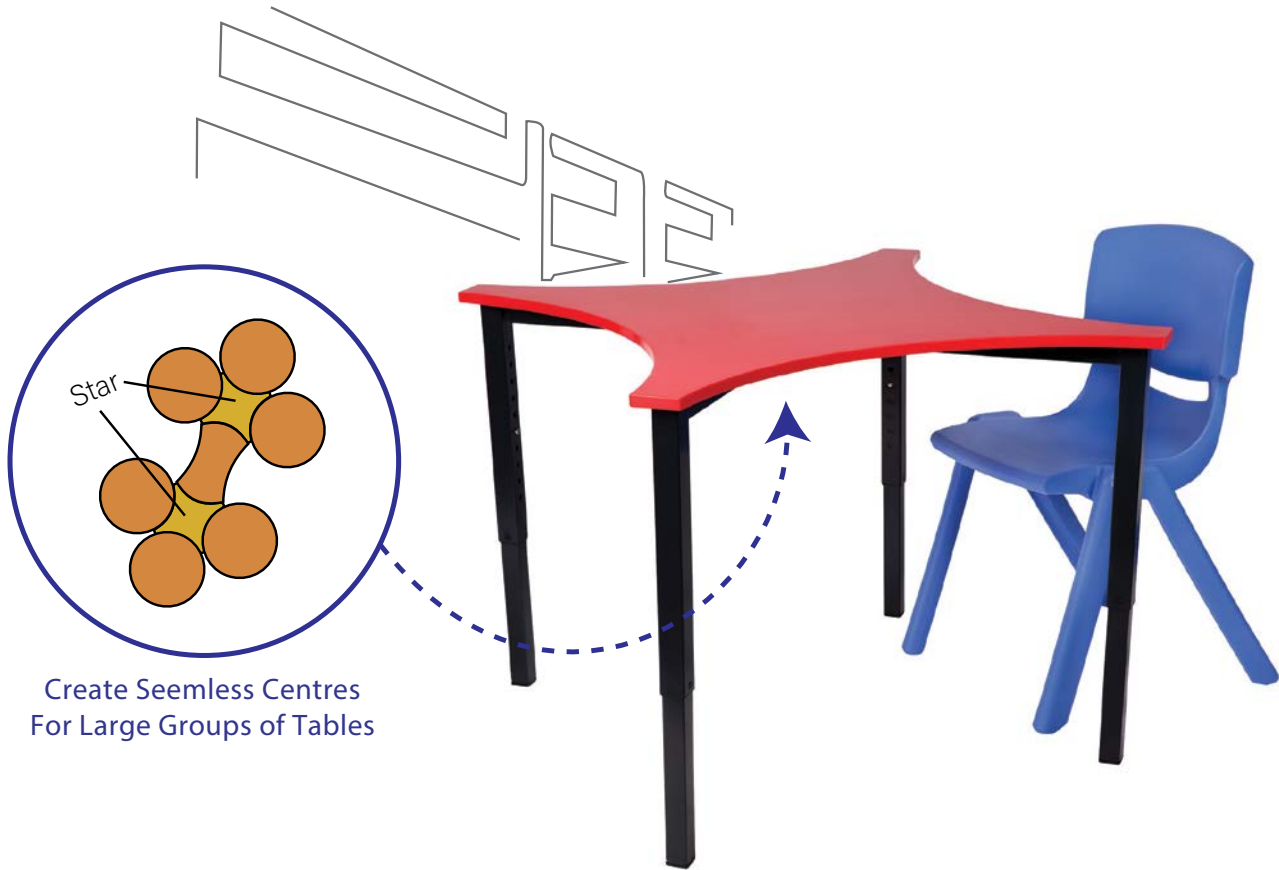

Create Seamless Centres
For Large Groups of Tables

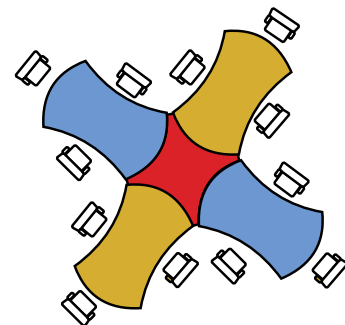
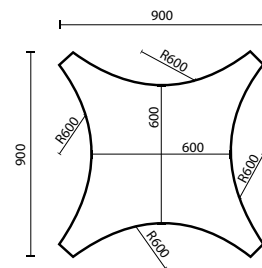

*All measurements are in millimetres

CRESCCENT Table

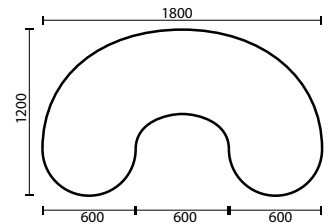

SEGMENT Table

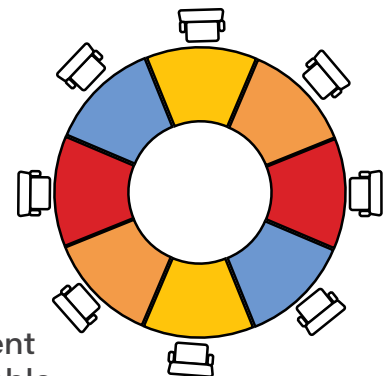
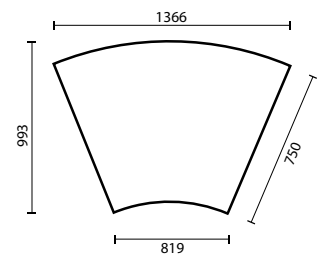
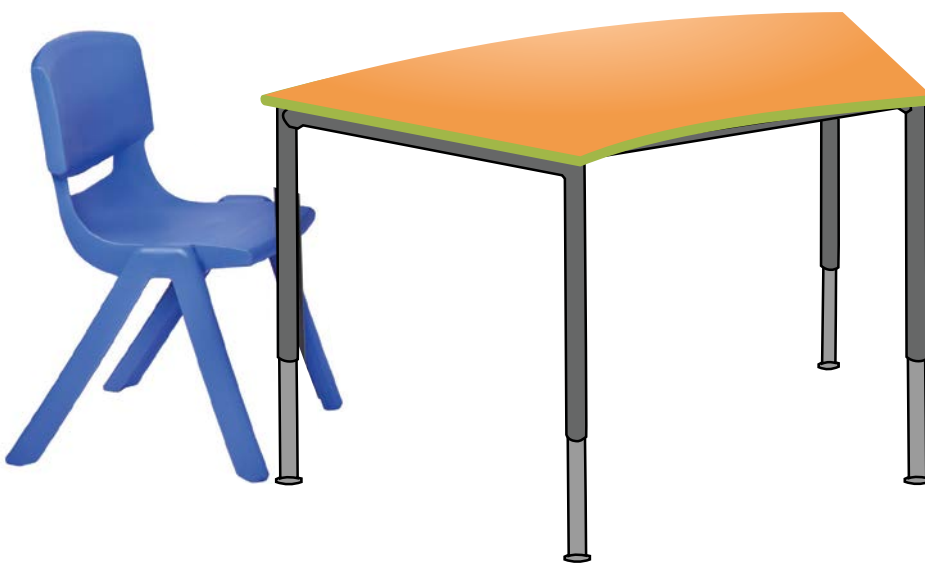

Eight Student
Carousel Table
Created with six Segment Tables

TEKNIK Table

The Teknik table is one of the largest tables in our collaborative educational range. By itself, the massive 1800mm by 900mm surface area can comfortably fit six students while the flat end may be joined with another Teknik table, suitable for large groups of students or teacher meetings.

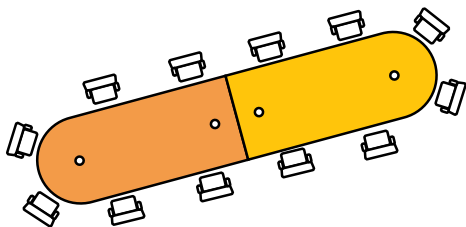

Twelve Student Boardroom Table
Created with two 1800x750mm Teknik Tables

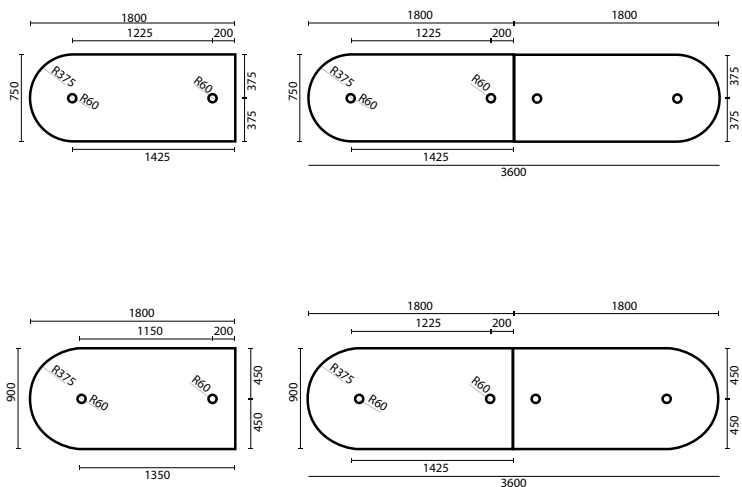

*All measurements are in millimetres

STUDENT Table

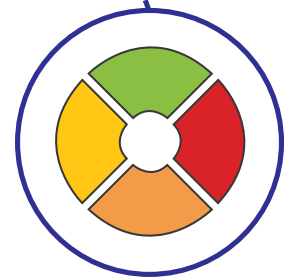

Wide Range of Colours to
Suit All Classrooms



Three Years Warranty
Quality Guaranteed





Drawers are optional
Surcharges apply

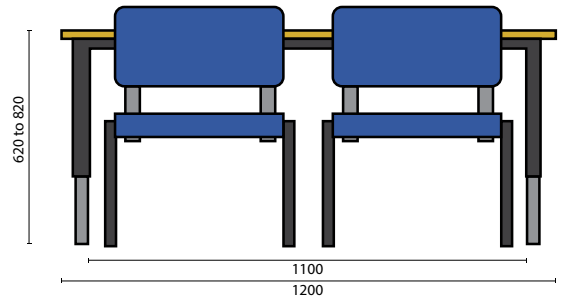

Our student tables come just as customisable as the rest of our range! All student tables are usable with two large plastic drawers that can be effortlessly removed as usable trays. In addition they may be additionally modified for adjustable leg heights, wheels and castors. Our tables also come with a full three years warranty!

TRANSIT Table

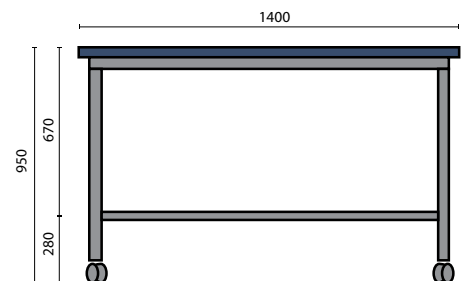
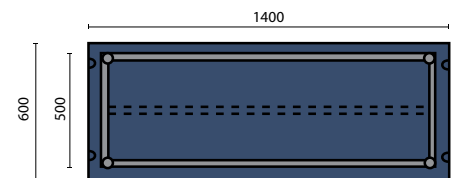

*All measurements are in millimetres

ADDITIONAL Range

We pride ourselves on crafting the perfect table that is right for you! In addition to the previous tables showcased, we can work with you to create the perfect table that is right for your teaching style and environment.

CLOUD Table

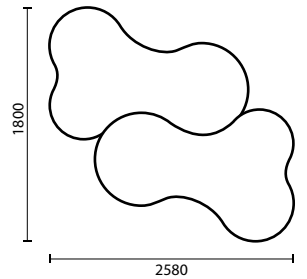
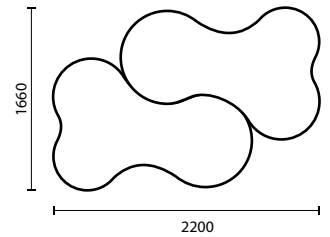
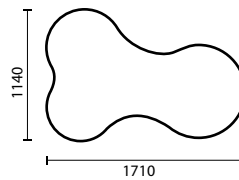
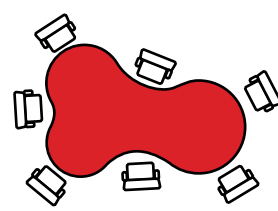
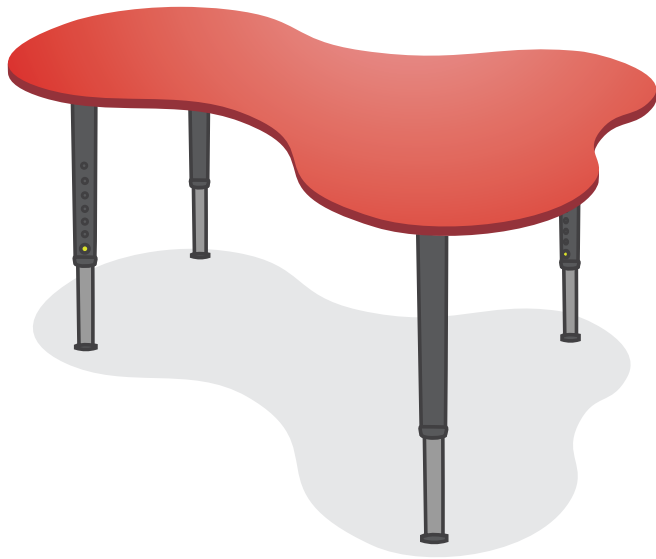

CRYSTAL Table

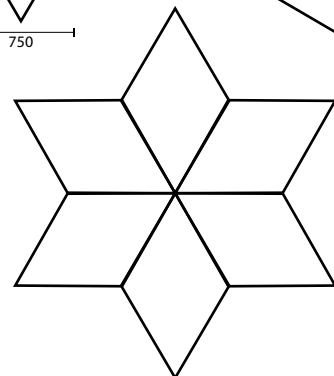
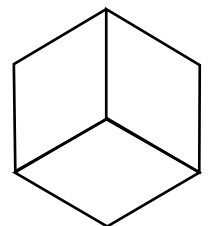
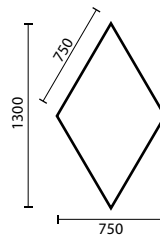
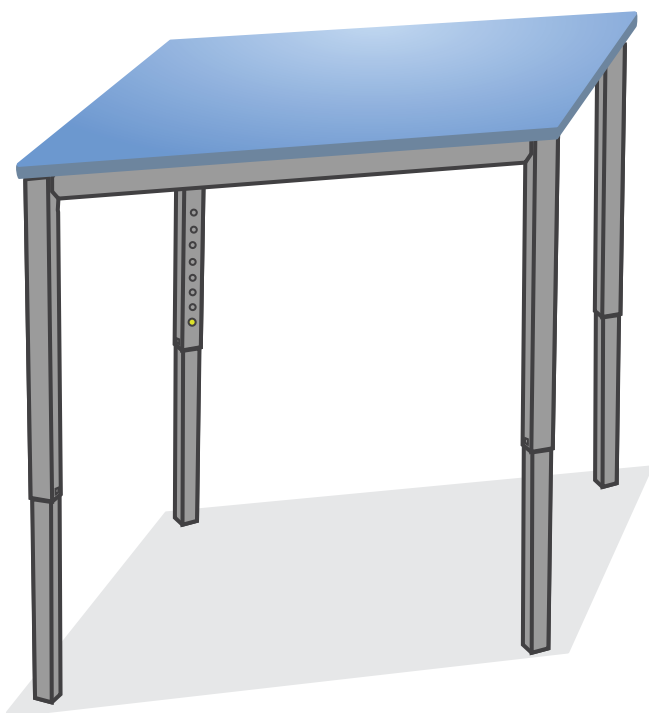

CLOVER Table

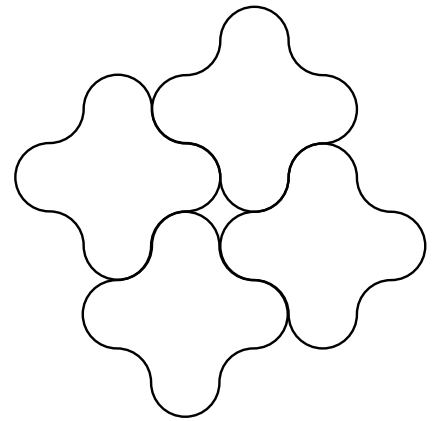
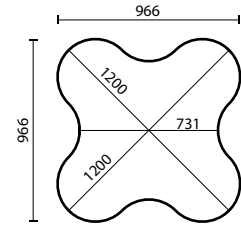

ZEN Table

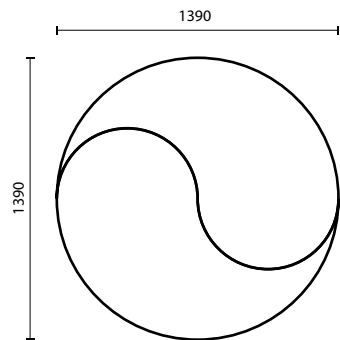
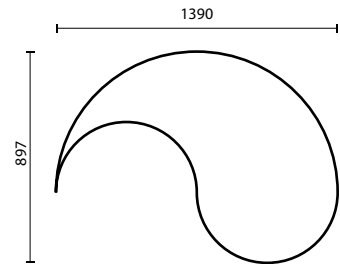

*All measurements are in millimetres

OTTOMAN Range

For an alternate seating solution, our Ottoman range creates a fun and unique configuration that provides just as much flexibility as our education table range. Available in all different shapes and sizes, they are the ideal way to tie together a collaborative learning environment. Our Ottoman range is constructed of solid Australian Made foam and upholstered in a range of house fabrics, vinyls or a fabric of your choice.

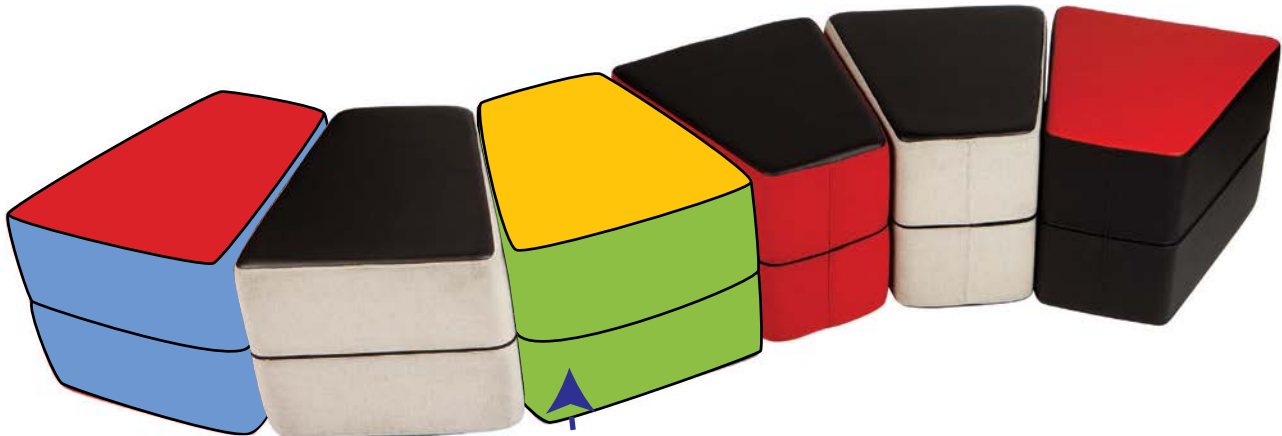

Wedge Ottoman
OTT SLI

100% Australian
Made



Round Ottoman
OTT ROU 50

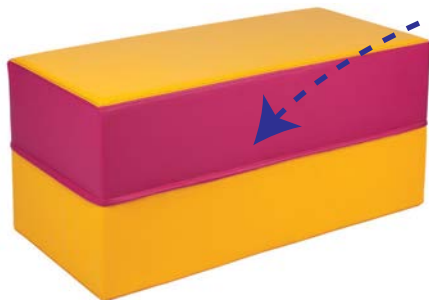
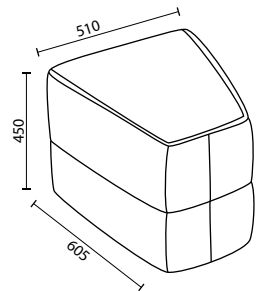
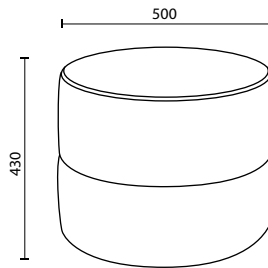

Rectangular Ottoman
OTT 90 45 45

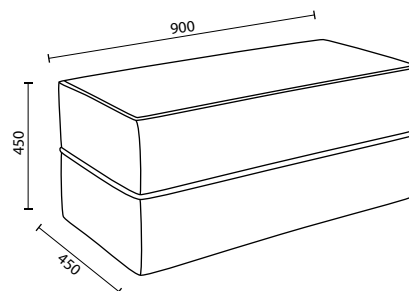

Strong Construction
That Survives The
Toughest Punishment



Kidney Ottoman
OTT KID 18 90

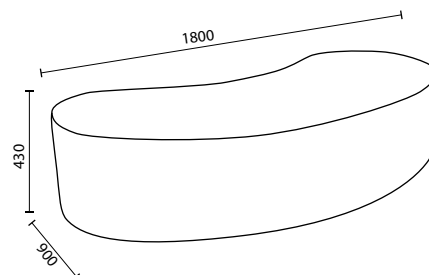

SWIFT Range

For a more traditional look in the classroom our Swift range of chairs are perfect. The Swift is available in many different colours and sizes and is constructed using high quality, long lasting polypropylene for durability and strength.



Swift 44
Swift 44

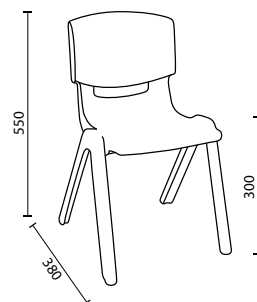
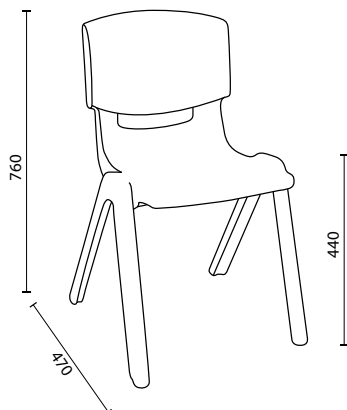

Wide Variety of Colours.
Charcoal and Blue Stocked,
all other colours available on order*



Neatly Stackable



Available in various student year groups
Size 46 and 30 stocked. All other sizes available on order*

*All measurements are in millimetres

Stocked in Black and Charcoal - Minimum Order Applies for Other Colours

SHELL / ANNE Seating

As one of our most versatile chairs, the Shell and Anne range can be outfitted with several options. Sled base for extra ease of use, a lecture table, fabric inserts for comfort or even outfit it with a gas-lift base for added versatility in the laboratory.



Shell 4 Leg
S01

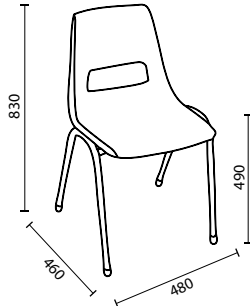

Shell Sled
SS01



Shell 4 Leg With Insert
S01 + 01



Shell Lecture
S01 + 03B



Shell Student
SG01



Anne Black Frame
A101

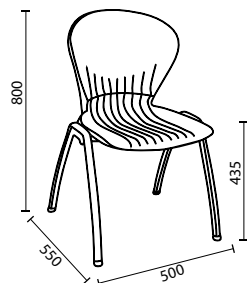

Anne Task Frame
A103 D



Anne Black With Arms
A101 + 02C



Anne Lecture
A101 + 03B



Anne Black With Insert
A101 + 01

EDUTECH Seating

The Edutech's lightweight, ergonomic design is a great option for the modern classroom. With a convenient hand grip and a seamlessly stackable shape, the Edutech is easy to move and store while the scratch-resistant seat surface can stand up to the toughest demands.



Modern, Ergonomic Design



Neatly Stackable

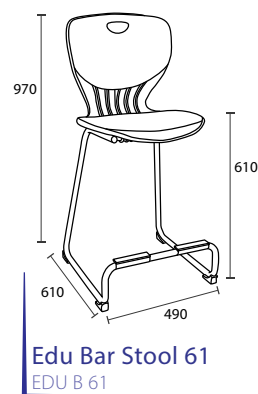
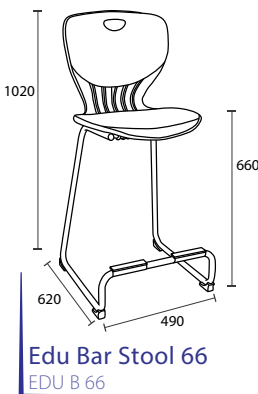
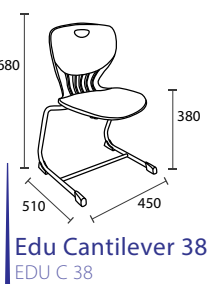
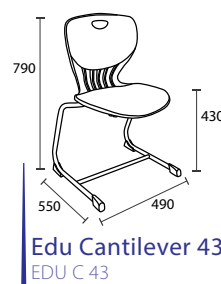
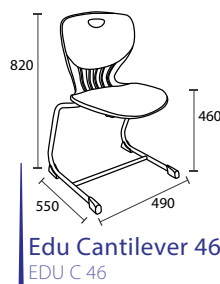
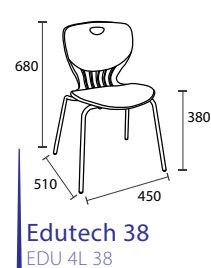
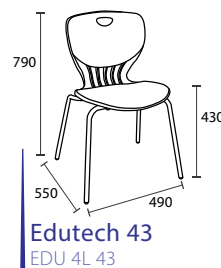
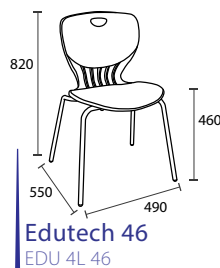

*All measurements are in millimetres

Stocked in Black and Charcoal - Minimum Order Applies for Other Colours

MULTI-PURPOSE Seating



Martin 4 Leg Base
MAR 20 4L B

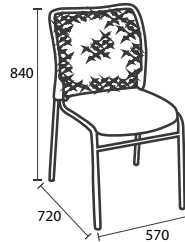

Martin Sled Base
MAR 20 SL B

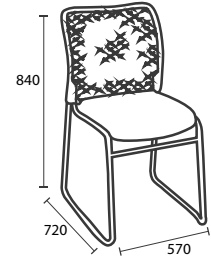

Lazer 40 Side Chair
LAZ 40 4L B

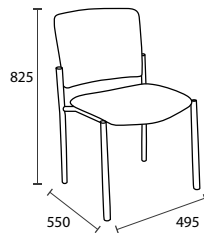

Tesla Cantilever
TES CA MEA

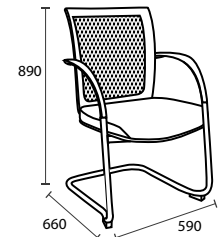

Sienna Multi Purpose
SIE 66

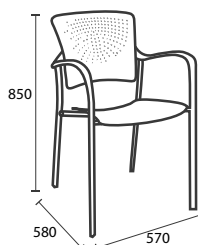

Sabi Chair
SABI 800

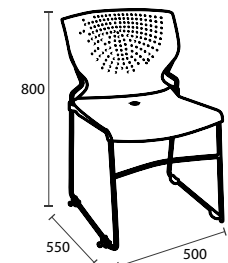

*All measurements are in millimetres

LECTURE Seating



Martin Lecture
MAR 20 4L B + 03B

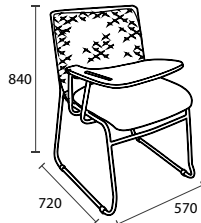

Bistro Lecture
BIS 001 + 03B

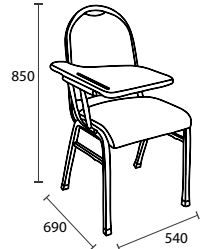

Nova Lecture
NOV 001 + 03B

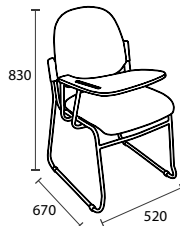

Joshua Lecture
JOS 601 + 03B

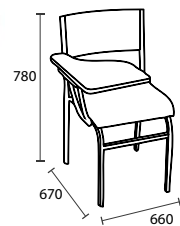

Shell Lecture
S01 + 03B

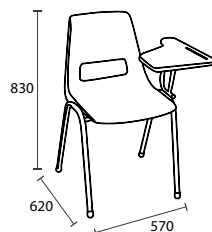

Anne Lecture
A101 + 03B

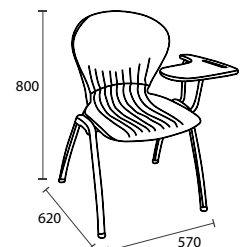

*All measurements are in millimetres

For the whole lecture range please refer to our general catalogue

LAB Seating

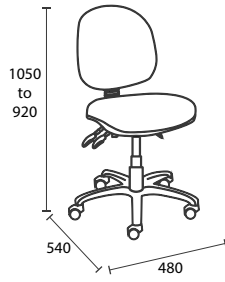

Ergo Clerical
ERG 300

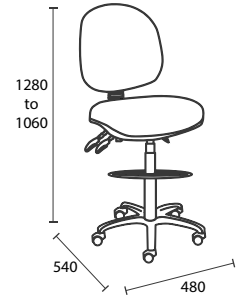

Ergo Drafting
ERG 300 D

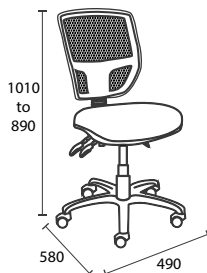

Lily Task
LIL 30

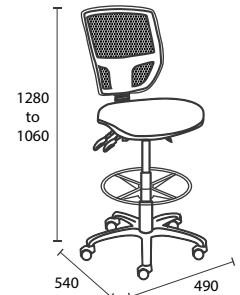

Lily Drafting
LIL 30 D

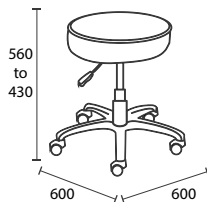

Solo Adjustable Stool
SOL S

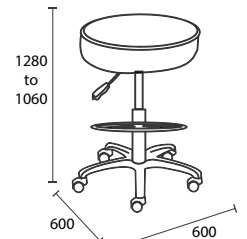

Lab Stool
LAB D S

*All measurements are in millimetres
For the whole task range refer to general catalogue

EXECUTIVE Seating



Boeing PU - Bariatric Executive
BOE EX PU

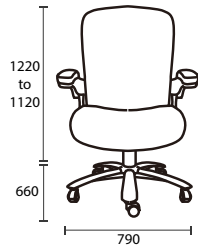

BIFMA
INTERNATIONAL

5
YEARS WARRANTY

200 KG
26.5 KG



Boeing Mesh - Bariatric Executive
BOE EX ME

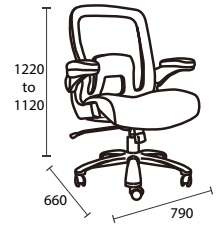

BIFMA
INTERNATIONAL

5
YEARS WARRANTY

200 KG
26.7 KG



Bentley Executive High Back
BE 40 EX CH HB

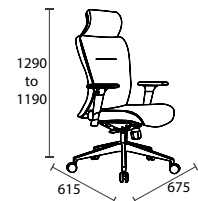

BIFMA
INTERNATIONAL

furntech
Australian Furnishing Research & Development Institute

3
YEARS WARRANTY

140 KG
22.5 KG



Bentley Executive Low Back
BE 40 EX CH LB

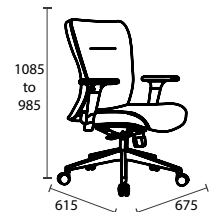

BIFMA
INTERNATIONAL

furntech
Australian Furnishing Research & Development Institute

3
YEARS WARRANTY

140 KG
22.5 KG



Bentley Cantilever
BE 40 CA CH

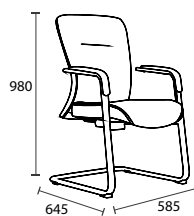

furntech
Australian Furnishing Research & Development Institute

3
YEARS WARRANTY

120 KG
18.5 KG



Avatar Mesh Executive
AVA EX CH +HR

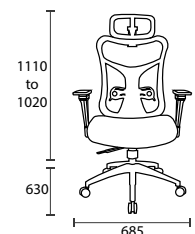

3
YEARS WARRANTY

140 KG
23 KG

*All measurements are in millimetres
For the whole executive range please refer to our general catalogue

BENCHES & OTTOMANS



Café Round

Available in:
Height 450mm Seat Ø 450mm
Height 500mm Seat Ø 500mm



Café Square

Available in:
Height 450mm Depth 450mm
Height 500mm Depth 500mm



Café Rectangular

Height 450mm length 980mm
Depth 450mm
(Also available in 1480mm length)



1000 Ø Ottoman



¼ Arch Ottoman



Low Back Corner Unit



¼ Arch Concave Ottoman



Twist

Available in Black PU and local upholstery
Linkable



2s Hi Back Double Sided



2s Low Back Single Sided

BENCHES & OTTOMANS

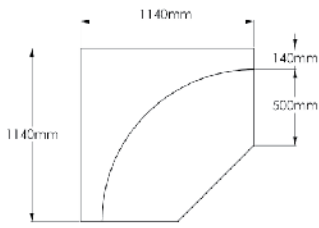

Corner Unit

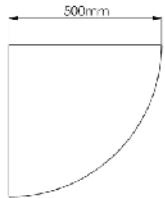

Small ¼ Circle Ottoman

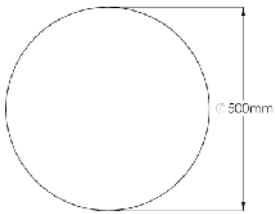

Small Round Ottoman

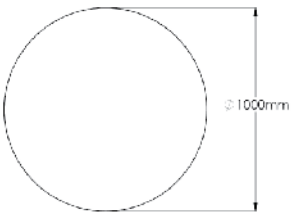

Large Round Ottoman

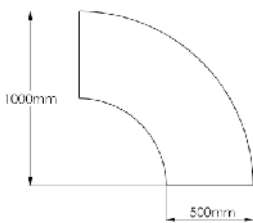

Large ¼ Circle Ottoman

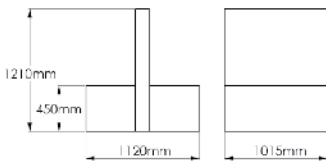

Hi Back Double Sided Unit

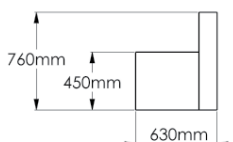

Low Back Single Sided Unit

BENCHES & OTTOMANS



1/4 Arch Concave Unit

Seat Height 445
Seat Depth 500
Overall Height 760

1/4 Arch Convex Unit

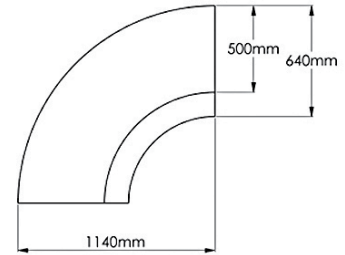

All furniture can be upholstered to your specified requirements

BENCHES & OTTOMANS



Modena Ottoman Square
Height 420mm length 650mm
Depth 650mm



Modena Ottoman Rectangular
Height 420mm length 1100mm
Depth 650mm
(Also available in 1600 & 2100mm lengths)



Marco Ottoman
Height 450mm Depth 480mm
Available in Square & in Lengths 960mm
& 1500mm



Podium Ottoman
Height 410mm Depth 650mm
Available in Square & in
Lengths 1600mm & 2100mm



Stein Ottoman
Height 430mm Sides 330mm



Round Nesting Ottomans



Hat
Height 420mm Seat Ø 600mm



Leaf Break Out Seating
Optional low or high backs
Available in all local materials



Island 2400 x 1400
Height 850mm Width 2400mm
Depth 1400mm



Konnect 1s
Height 760mm Width 660mm
Depth 660mm



Oval Ottoman
Height 440mm length 1800mm
Depth 600mm

BENCHES & OTTOMANS



Half Moon Ottoman

Height 455mm length 1000mm
Depth 500mm



Leaf Ottoman

Height 455mm length 1000mm
Depth 500mm



Cuba

Height 380mm length 1000mm
Depth 1000mm



Pod Ottoman

Ø 1200mm
Height 320mm

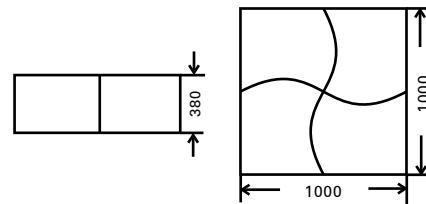

Jigsaw Ottoman

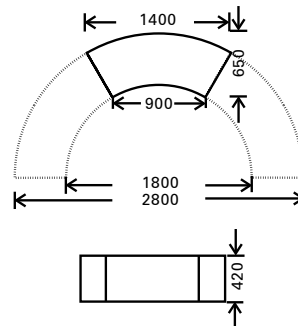

Band Ottoman

All furniture can be upholstered to your specified requirements

BANQUETTE SEATING



Integra Modular Units

h 825mm h 465mm



Custom Banquette Seating



Circular Banquette

Ø 1800mm

Height 900mm Seat Height 420mm



Blitz Modular

All furniture can be upholstered to your specified requirements

BLINDS

Roller Blinds

With an extensive range of fabric and colour choices, roller blinds offer you a versatile solution for your window furnishing requirements. Available in blockout, light filtering, sunscreen or a combination of both – one for day, one for night. With chain drive, linked, twin, spring assist and motorisation, roller blinds offer an affordable, practical and versatile window covering solution.



Options:

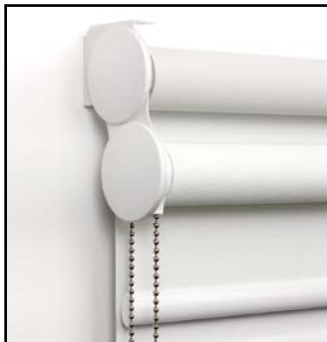

Twin Systems



Chain Drive



Motorised



Remote control

Vertical Blinds

With an affordable price tag, privacy and light are easily controlled. The slats stack neatly open allowing maximum viewing capacity. Vertical Blinds are available in a range of slat sizes and come with the option of centre open or side bunch.



BLINDS - Fabric Selections & Specifications

GreenQ Block

Roller, Roman & Panel Fabric



- Application:**
- Roller, Roman and Panel Window Blinds
 - Wide Width Windows

- Characteristics:**
- Width: 2800mm

- Technical:**
- 100% Polyester with Foamed Acrylic Backing
 - PVC free
 - Lead free
 - Nominal Thickness: 0.43mm
 - Nominal weight: 380 gsm
 - Light Fastness: Minimum 6 (Blue Scale) Tested to ISO 105-B02:2014

- Performance:**
- Opacity: Blackout (complies to AS 2663.2. 1999)
 - UV Protection: 98% (tested to S/NZS 4399:1996)

- Protection:**
- Complies with Building Code of Australia requirements for Class 2 to 9 (a) buildings. Tested to AS 1530 Part III.
 - Air Quality: VOC Tested US EPA 5021A:2003
 - Greenguard Gold Accredited (no harmful VOC emissions)

- Care:**
- Surface dust should be removed with duster or soft cloth. Never use abrasive products or solvent/industrial based cleaners.

Colour Range *



GreenQ - Block



* Images representative only

BLINDS - Fabric Selections & Specifications

GreenQ Screen

Roller, Roman & Panel Fabric



Application:

- Roller, Roman and Panel Window Blinds
- Wide Width Windows

Characteristics:

- Width: 2500mm | 3200mm

Technical:

- Composition: 27% Polyester 73% Vinyl on Polyester
- Weave: 2x1
- Openness Factor: Approximately 5%
- Nominal Thickness: 0.69mm
- Nominal weight: 471gsm
- Light Fastness: 4-5 minimum 5 (Blue Scale)
- Formaldehyde Free | Lead Free
- Printable

Performance:

- Energy Saving
- UV Protection: 95%

Protection:

- Tested to AS1530 Part III
- Greenguard Gold - accreditation for use in the sensitive areas eg schools and healthcare facilities (tested against California Section 01359 for low chemical emissions (VOCs)).

Care:

- Surface dust should be removed with duster or soft cloth. Fabric may be wiped with a damp sponge and dried with a clean cloth. Never use abrasive products or solvents/ industrial based cleaners. Do not roll up fabric which is damp.

GreenQ - Screen Solar Optical Properties:

Colour	Solar Optical Properties					Shading Coefficient		
	Ts	Rs	As	Tv	Tuv	3mm CL	6mm CL	6mm HA
White	22	71	7	20	7	0.31	0.32	0.31
White Stone	19	64	17	17	6	0.35	0.35	0.33
White Linen	21	63	16	19	7	0.37	0.37	0.34
Dune Grey	13	38	49	13	7	0.53	0.51	0.41
White Grey	13	53	34	14	6	0.42	0.41	0.36
Blue Grey	13	49	38	14	6	0.45	0.44	0.37
Charcoal Grey	7	13	80	11	6	0.69	0.65	0.48
Charcoal Slate	8	17	75	10	6	0.66	0.63	0.47
Charcoal	8	4	88	9	6	0.75	0.70	0.51

(Fabrics installed internally zero-degree profile angle)
 Ts: Solar Transmittance As: Solar Absorptance 3mm CL: 3mm Clear Glass 6mm HA: Heat Absorbing Glass
 Rs: Solar Reflectance Tv: Visual Transmittance Tuv: Ultraviolet Transmittance 6mm CL: 6mm Clear Glass

Colour Range *

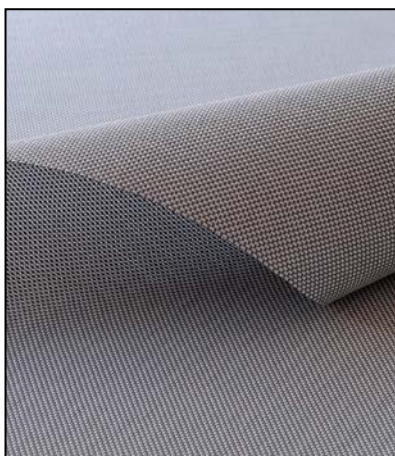

GreenQ - Screen

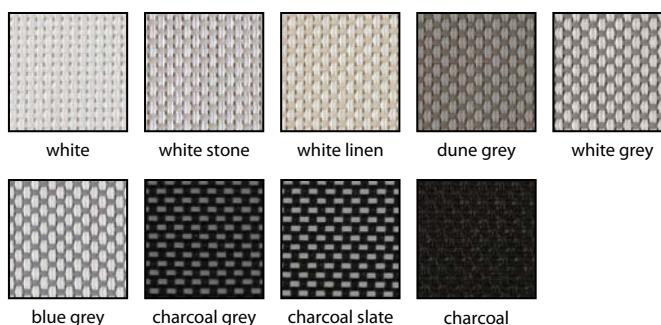

* Images representative only

BLINDS - Fabric Selections & Specifications

eco block Roller, Vertical & Panel Fabric



- Application:**
- Roller, Vertical and Panel Blinds
 - Wide Width Windows

- Characteristics:**
- 28 matt finishes, 3 metallic finishes
 - Matt 6 widths: 89mm, 100mm, 127mm, 2000mm, 2500mm, 3000mm
 - Metallic 4 widths: 89mm, 100mm, 127mm, 3000mm

- Technical:**
- Composition: 100% polyester with acrylic coating
 - Nominal Weights: 360gsm - 400gsm
 - Nominal thickness: 0.33mm - 0.36mm
 - PVC & Lead free
 - Light Fastness: minimum 6 (Blue Scale). Tested to ISO 105-B02:2014
 - Cutting: Ultrasonic, Crush, Knife

- Performance:**
- Opacity: Blackout. Exceeds standard AS2663.3:1999.
 - Dust and Mould Resistant

- Protection:**
- Complies with Building Code of Australia requirements for Class 2 to 9 (a) buildings.
 - Tested to AS 1530 Part III.
 - Air Quality: VOC Tested US EPA 5021A:2003
 - Greenguard Gold Accredited (no harmful VOC emissions)

- Care:**
- Surface dust should be removed with duster or soft cloth. Fabric may be wiped with a damp sponge and dried with a clean cloth. Never use abrasive products or solvents/industrial based cleaners. Do not roll up fabric which is damp.



* Images representative only

STAGE CURTAINS

Quicksew can manufacture and install your Performance Curtain requirements. Select from a wide range of Theater Wool, Velvets and Soft drapes in a wide range of colours.

All fabrics are flame retardant to Australian Standards. Transform your performance space with backdrops, valances, legs and a motorised front stage curtain track.

To discuss any of your performance space requirements please contact the team at quicksew.



EDUCATION SOLUTIONS

Quicksew are your Single Source Company for Interior Solutions for Schools & Educational Facilities. Like to know more? Give our experienced staff a call on 1800 065 068



OFFICE SEATING
Executive, ergonomic,
task seating.



STUDENT SEATING
Wide range, custom options,
timber or metal frame.



STAGE CURTAINS
Range of options,
custom design.



MODULAR
Wide range, endless
configurations, custom options.



WINDOW SOLUTIONS
Blinds, curtains, motorisation,
tracking.



BEAM SEATING
2/3/4/5 run options, wide range,
w/without arms.



OFFICE FURNITURE
Desks, bookcases, returns,
mobile pedestals etc.



TABLES
Student, conference, meeting,
occasional, flip, dining, timber/laminate.



ACOUSTIC SOLUTIONS
Artworks, panels, ceilings,
baffles, clouds, blades.



SHOWROOM OPEN: Monday - Friday 8.00am to 5.00pm
16 Bradwardine Road, Bathurst NSW 2795

Freecall 1800 065 068
Email: reception@quicksew.com.au
www.quicksew.com.au