



Grates & Drains

3monkeez[®]
innovate. create. deliver.



2022

3monkeez[®]

www.3monkeez.com.au

sales@3monkeez.com.au

The Stainless Steel Advantage

Contents

In2Gr8 – V Bottom 50 Series	3	Floor Trough 2	15
In2Gr8 – V Bottom 75 Series	4	Floor Grate & Frame	16
In2Gr8 – V Bottom 100 Series	5	Floor Trough 4	17
In2Gr8 – V Bottom 125 Series	6	Floor Trough 5	18
In2Gr8 – V Bottom 150 Series	7	Smart Trough	19
In2Gr8 – Flat Bottom 75 Series	8	Floor Sump	20
In2Gr8 – Flat Bottom 100 Series	9	Grating Profiles	21
100mm Square Tile Insert Point Drain	10	Wedge Wire Grates to suit M-FT-7 and M-FT-8	22
130mm Square Tile Insert Point Drain	11	Wedge Wire G100	23
Stainless Steel Tile Insert Point Drain	12	Wedge Wire G200	24
130mm Wedge Wire Point Drain	13	Wedge Wire G300	25
Floor Trough 1	14		



Grates & Drains



In2Gr8 - V Bottom 50 Series



M-FT-7-050 (with G200 grate)

- Manufactured using 316 grade stainless steel
- Available in kit form or pre-fabricated to your requirement
- Kit form includes a hole saw and sealant
- 38mm outlet
- G200 wedge wire grate
- Corners available - 45 degree or 90 degree
- Joining strips available for continuous runs
- Typically used in showers, bathroom areas, balconies, courtyards and swimming pool areas
- Short lead times

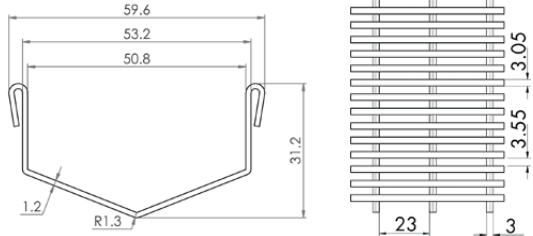

Channel



Grate



End Cap



Outlet



Joining Strip



Corner



Grates & Drains



In2Gr8 - V Bottom 75 Series

M-FT-7-075 (with G200 grate or tile insert)

- Manufactured using 316 grade stainless steel
- Available in kit form or pre-fabricated to your requirement
- Kit form includes a hole saw and sealant
- 38mm or 50mm outlet
- Either G200 wedge wire grate or tile insert
- Corners available - 45 degree or 90 degree
- Joining strips available for continuous runs
- Typically used in showers, bathroom areas, balconies, courtyards and swimming pool areas
- Short lead times

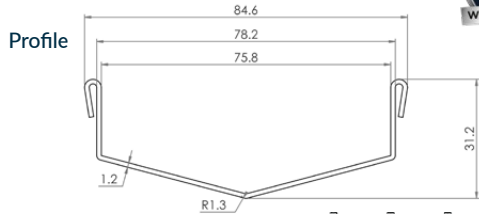

Channel

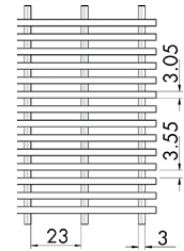

Grate



Tile Insert

Tray Depth
10.4mm



End Cap



Outlet



Joining Strip



Corner



Grates & Drains



In2Gr8 - V Bottom 100 Series



M-FT-7-100 (with G200 grate or tile insert)

- Manufactured using 316 grade stainless steel
- Available in kit form or pre-fabricated to your requirement
- Kit form includes a hole saw and sealant
- 38mm, 50mm, 76mm or 89mm outlet
- Optional fixed and removable strainer
- Either G200 wedge wire grate or tile insert
- Corners available - 45 degree or 90 degree
- Joining strips available for continuous runs
- Typically used in showers, bathroom areas, balconies, courtyards and swimming pool areas
- Short lead times

Profile

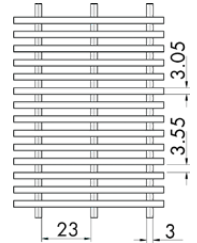
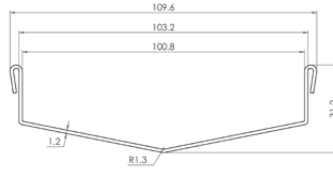

Channel



Grate



Tile Insert



End Cap



Outlet



Fixed and Removable Strainers



Joining Strip



Corner



Grates & Drains



In2Gr8 - V Bottom 125 Series



M-FT-7-125 (with G300 grate)

- Manufactured using 316 grade stainless steel
- Available in kit form or pre-fabricated to your requirement
- Kit form includes a hole saw and sealant
- 89mm outlet
- Optional fixed and removable strainer
- G300 wedge wire grate
- Joining strips available for continuous runs
- Typically used in driveway areas, balconies, courtyards and swimming pool areas
- Short lead times

Profile

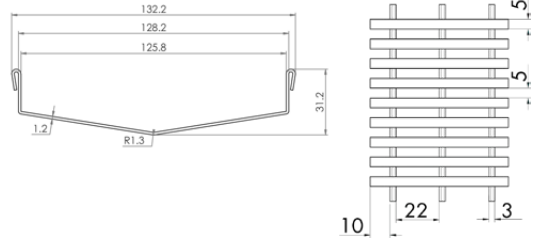

Channel



Grate



End Cap



Outlet



Fixed and Removable Strainers



Joining Strip



Grates & Drains



In2Gr8 - V Bottom 150 Series



M-FT-7-150 (with G300 grate)

- Manufactured using 316 grade stainless steel
- Available in kit form or pre-fabricated to your requirement
- Kit form includes a hole saw and sealant
- 89mm outlet
- Optional fixed and removable strainer
- G300 wedge wire grate
- Joining strips available for continuous runs
- Typically used in driveway areas, balconies, courtyards and swimming pool areas
- Short lead times

Profile

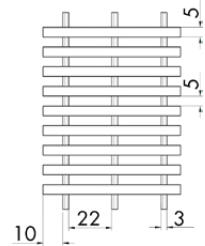
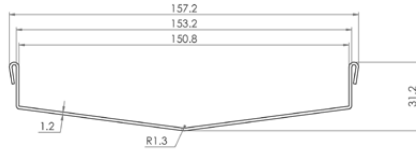

Channel



Grate



End Cap



Outlet



Fixed and Removable Strainers



Joining Strip



Grates & Drains



In2Gr8 - Flat Bottom 75 Series



M-FT-8-075 (with G200 grate or tile insert)

- Manufactured using 316 grade stainless steel
- Available in kit form or pre-fabricated to your requirement
- Kit form includes a hole saw and sealant
- 38mm or 50mm outlet
- Either G200 wedge wire grate or tile insert
- Corners available - 45 degree or 90 degree
- Joining strips available for continuous runs
- Typically used in showers, bathroom areas, balconies, courtyards and swimming pool areas
- Short lead times

Profile

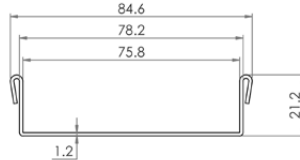

Channel

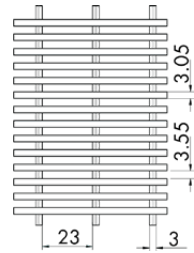

Grate



Tile Insert

Tray Depth
10.4mm



End Cap



Outlet



Joining Strip



Corner



Grates & Drains



In2Gr8 - Flat Bottom 100 Series

M-FT-8-100 (with G200 grate or tile insert)

- Manufactured using 316 grade stainless steel
- Available in kit form or pre-fabricated to your requirement
- Kit form includes a hole saw and sealant
- 38mm, 50mm, 76mm or 89mm outlet
- Optional fixed and removable strainer
- Either G200 wedge wire grate or tile insert
- Corners available - 45 degree or 90 degree
- Joining strips available for continuous runs
- Typically used in showers, bathroom areas, balconies, courtyards and swimming pool areas
- Short lead times



Profile

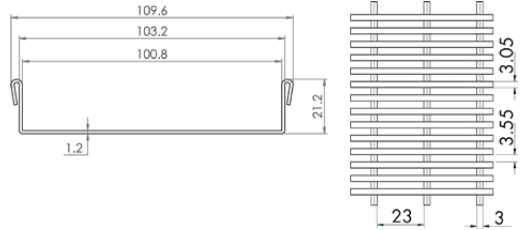

Channel



Grate



Tile Insert



Tray Depth
10.4mm

End Cap



Outlet



Fixed and Removable Strainers



Joining Strip



Corner



Grates & Drains



100mm Square Tile Insert Point Drain



FW-100TI-50 (50mm outlet)

- Slimline for easy installation
- Removable tray



Top

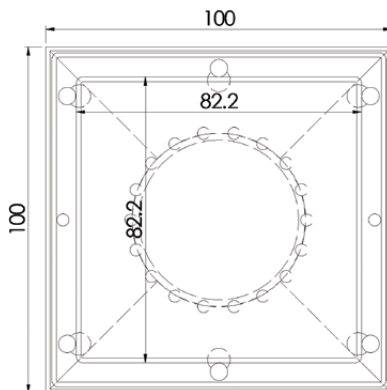

Front

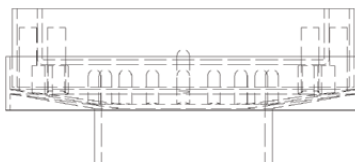

Cross Section

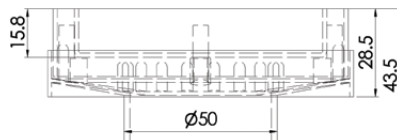

Grates & Drains



130mm Square Tile Insert Point Drain

FW-130TI (103.1mm outlet)

FW-130TI-80 (73.9mm outlet)

- Slimline for easy installation
- Removable tray



Top

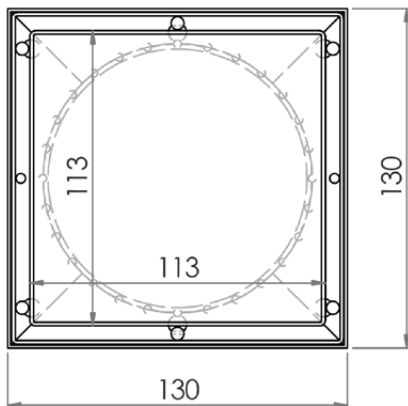

Front

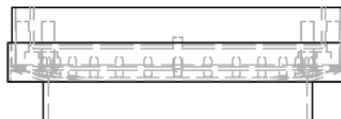

Cross Section

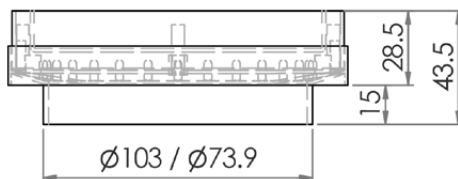

Grates & Drains



Stainless Steel Tile Insert Point Drains



FW-100STI

(100mm Square - 50mm Outlet)

FW-130STI

(130mm Square - 100mm Outlet)

FW-130STI-80

(130mm Square - 74mm Outlet)

- Slimline for easy installation
- 1.5mm 304 grade stainless steel
- Removable tray



Top

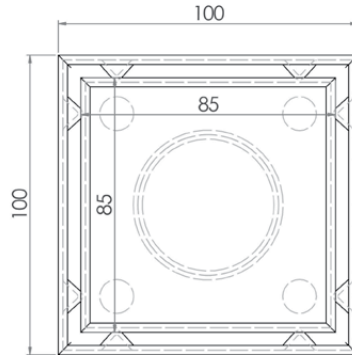

Front

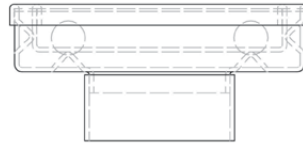

Cross Section

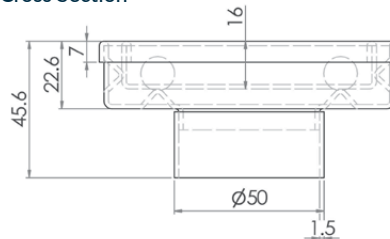

Grates & Drains



130mm Wedge Wire Point Drain



FW-130WWI

- Slimline for easy installation
- Removable grate
- G200 profile grate
- 89mm spigot
- 316 grade stainless steel
- In stock and available for immediate delivery
- Custom sizes available on request - lead times apply

Top

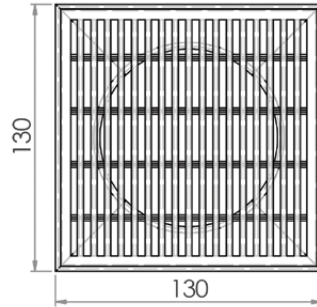

Front

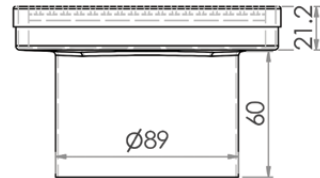

Side

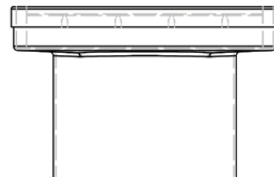

Grates & Drains



Floor Trough 1

M-FT-1

- Manufactured to required length and width, using a choice of either 304 or 316 grade stainless steel
- Optional fixed secondary strainer and removable strainer basket
- Size and position of the outlet is manufactured to the customer's requirements
- Typically used for commercial applications
- Manufactured with your choice of grating
- Loading as required
- Custom made product incurs a lead time

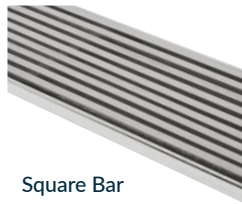
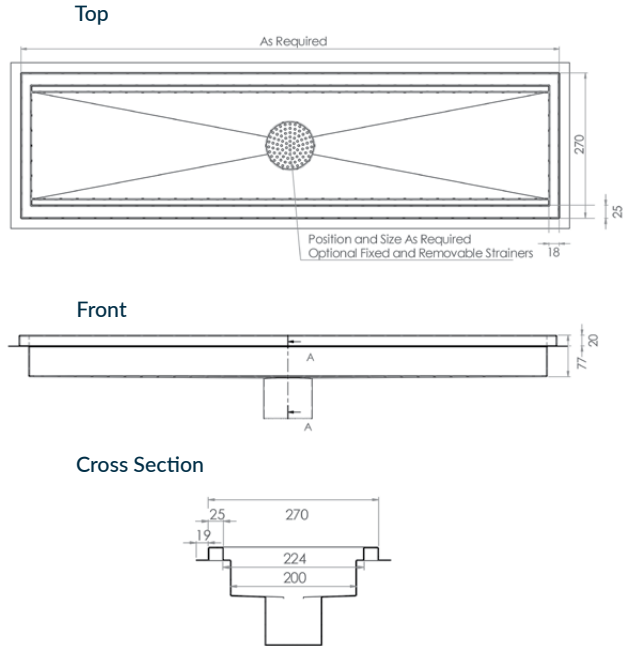

Square Bar



Wedge Wire

Grates & Drains



Floor Trough 2

M-FT-2

- Manufactured to required length and width, using a choice of either 304 or 316 grade stainless steel
- Optional fixed secondary strainer and removable strainer basket
- Size and position of the outlet is manufactured to the customer's requirements
- Typically used for commercial applications
- Manufactured with your choice of grating
- Loading as required
- Custom made product incurs a lead time

Top

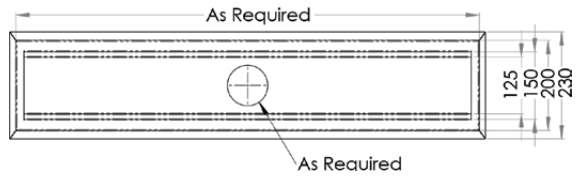

Front

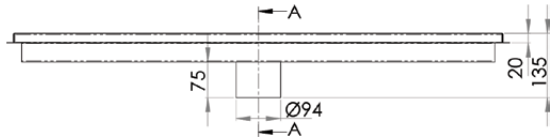

Cross Section

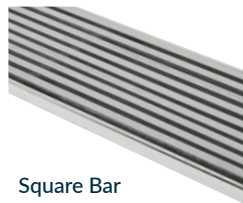
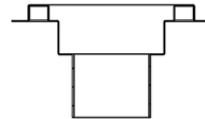

Square Bar

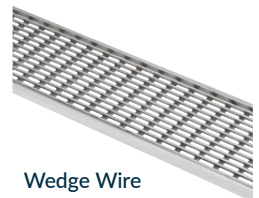

Wedge Wire

Grates & Drains



Floor Grate & Frame

M-FT-3

- Manufactured to required length and width, using a choice of either 304 or 316 grade stainless steel
- Ideal for both light and heavy duty applications
- Manufactured with your choice of grating
- Loading as required
- Custom made product incurs a lead time

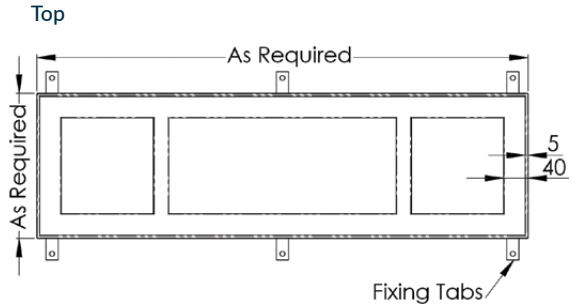

Front

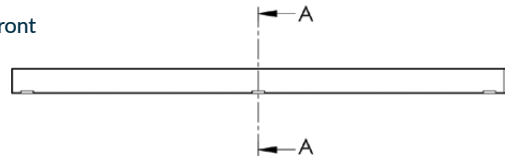

Cross Section

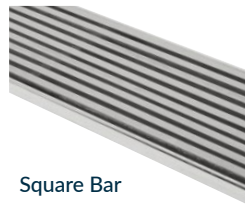
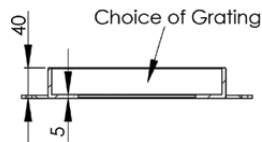

Square Bar

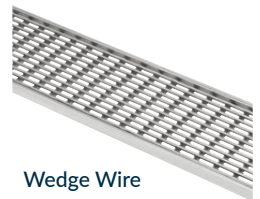

Wedge Wire

Grates & Drains



Floor Trough 4

M-FT-4

- Manufactured to required length and width, using a choice of either 304 or 316 grade stainless steel
- Optional fixed secondary strainer and removable strainer basket
- Size and position of the outlet is manufactured to the customer's requirements
- Typically used for commercial applications
- Manufactured with your choice of grating
- Loading as required
- Custom made product incurs a lead time

Top

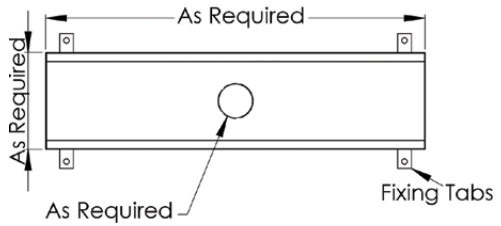

Front

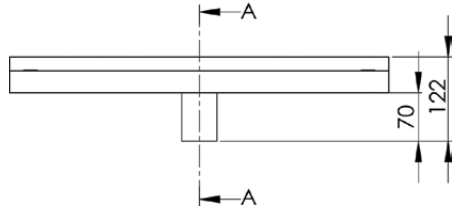

Cross Section

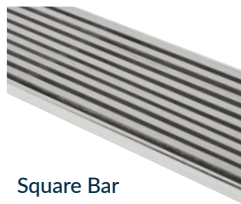
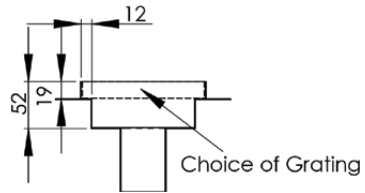

Square Bar

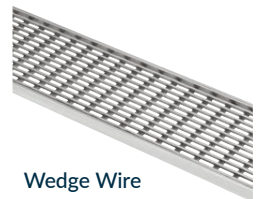

Wedge Wire

Grates & Drains



Floor Trough 5

M-FT-5

- Manufactured to required length and width, using a choice of either 304 or 316 grade stainless steel
- Size and position of outlet is manufactured to the customer's requirements
- Typically used in showers, bathrooms and balcony areas
- Manufactured with your choice of grating
- Loading as required
- Custom made product incurs a lead time



Top

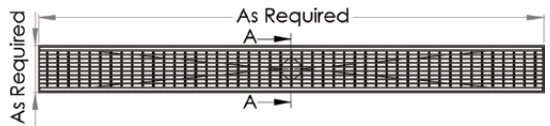

Bottom

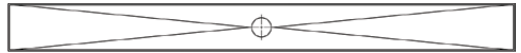

Side

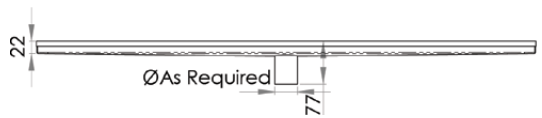

Cross Section

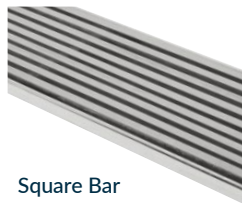
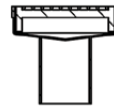

Square Bar

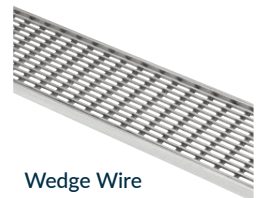

Wedge Wire

Grates & Drains



Smart Trough

M-FT-6

- Manufactured to required length and width, using a choice of either 304 or 316 grade stainless steel
- Size and position of outlet is manufactured to the customer's requirements
- Tile tray depth can be modified to your requirement
- Typically used in showers, bathrooms and tiled balcony areas
- Accepts a tile finish
- Custom made product incurs a lead time

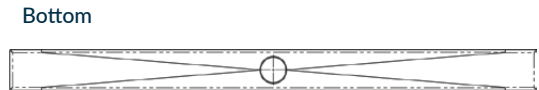
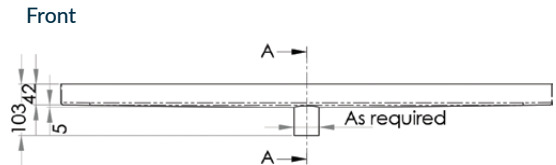
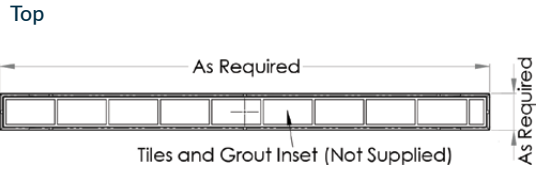

Cross Section

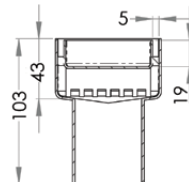

Grates & Drains



Floor Sump

M-FS-1

- Manufactured to required length and width, using a choice of either 304 or 316 grade stainless steel
- Optional fixed secondary strainer and removable strainer basket
- Typically used in commercial or industrial settings, as well as food preparation areas
- Manufactured with your choice of grating
- Loading as required
- Custom made product incurs a lead time



Top

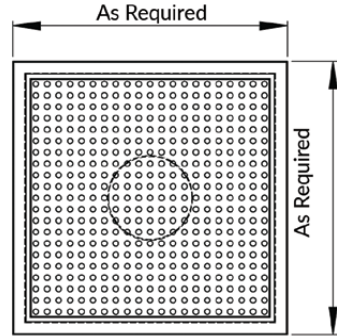

Front

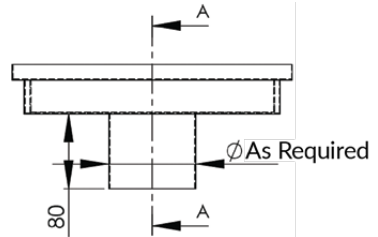

Cross Section

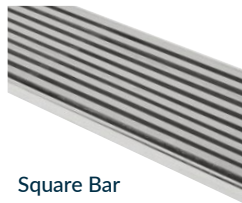
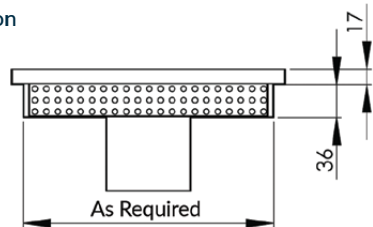

Square Bar

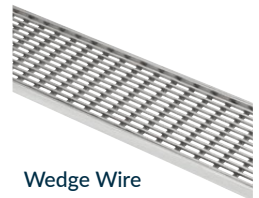

Wedge Wire

Grates & Drains



Grating Profiles

M-SBGO (*square bar*)

- Modern lineal design
- Robust
- Designed for domestic and commercial applications
- Manufactured to required length and width, using a choice of either 304 or 316 grade stainless steel
- Light to heavy duty
- Grate manufactured from 6mm or 10mm stainless steel square bar

M-SBGO



M-WWGO (*wedge wire*)

- Unique self-cleaning design
- Manufactured to required length and width, using a choice of either 304 or 316 grade stainless steel
- Aesthetically pleasing design
- Loading as required
- Three profiles available (WW-G100, WW-G200 and WW-G300)

M-WWGO



Grates & Drains



Wedge Wire Grates To Suit In2Gr8



- Manufactured using 316 grade stainless steel
- Lengths ranging from 900mm – 2400mm
- Typically used in showers, bathroom areas, balconies, courtyards and swimming pool areas

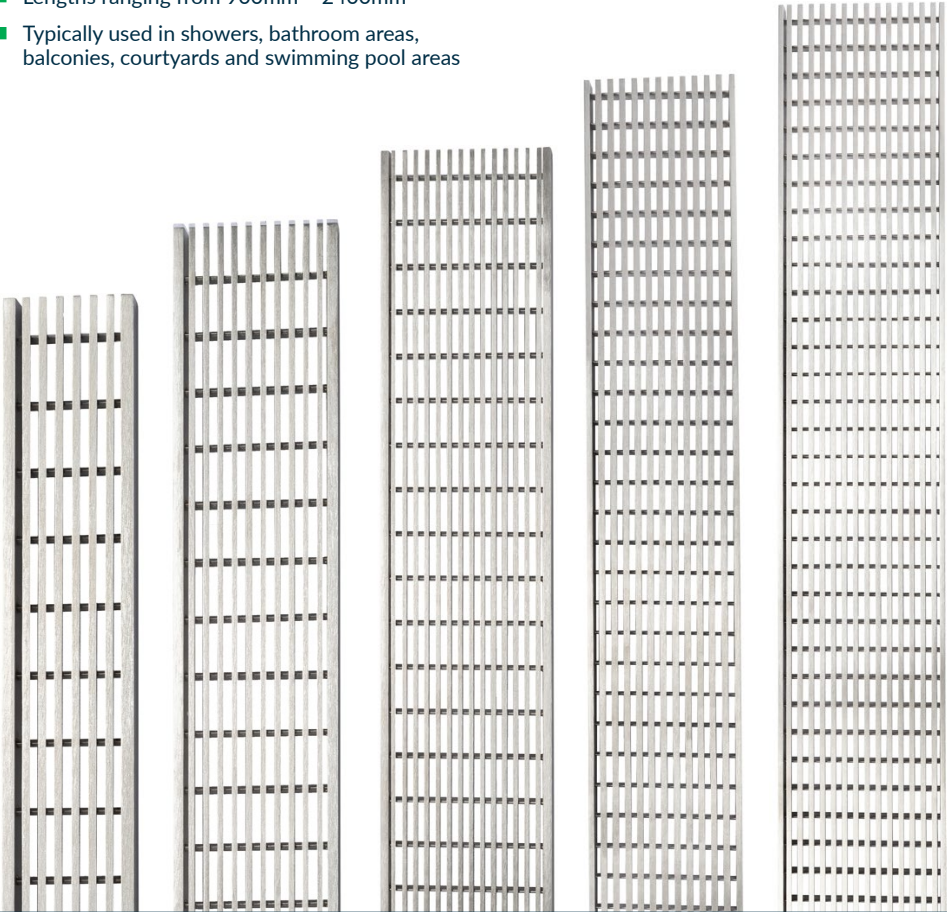

G200
50mm

G200
75mm

G200
100mm

G300
125mm

G300
150mm

Grates & Drains



Wedge Wire G100



WW-G100-304 (304 grade)

WW-G100-316 (316 grade)

- Wire Size
2.25mmW x 3.50mmH. Gap 5.00mm
- Support Bars
3.00mmW x 6.25mmH. Gap 16.00mm
- Convenient sheet size minimises wastage - 2400mm x 727mm
- 304 or 316 grade stainless steel
- Versatile and long lasting
- Flat bed manufacturing technique - not rolled
- Available off the shelf

Top

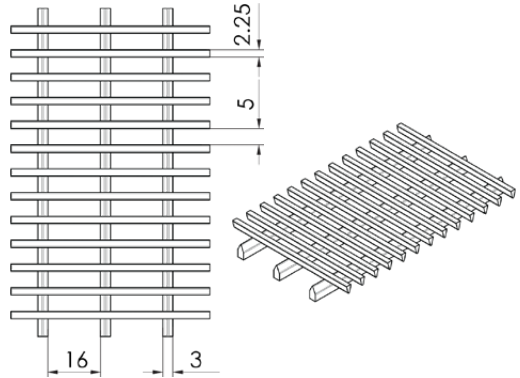

Side

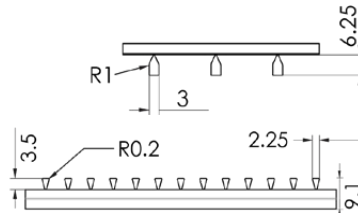

Bottom

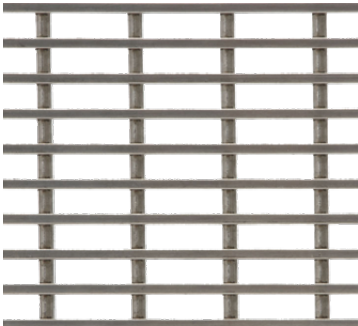
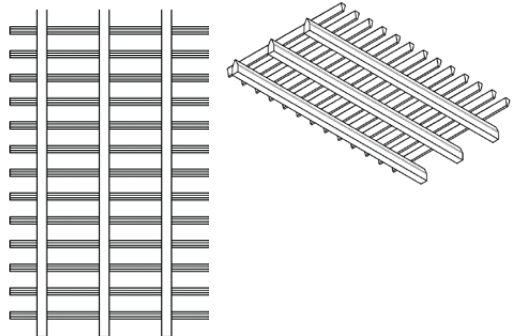

Grates & Drains



Wedge Wire G200



WW-G200-304 (304 grade)

WW-G200-316 (316 grade)

- Wire Size
3.05mmW x 4.25mmH. Gap 3.55mm
- Support Bars
3.00mmW x 6.25mmH. Gap 23.00mm
- Convenient sheet size minimises wastage - 2400mm x 727mm
- 304 or 316 grade stainless steel
- Versatile and long lasting
- Flat bed manufacturing technique - not rolled
- Available off the shelf

Top

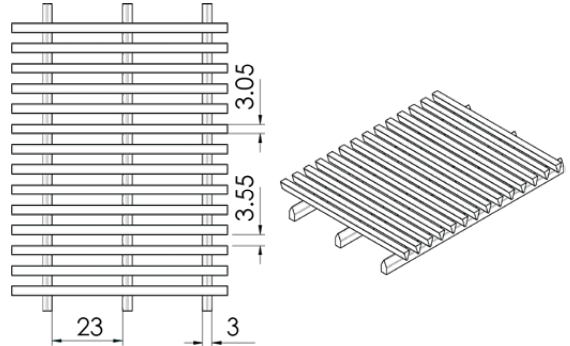

Side

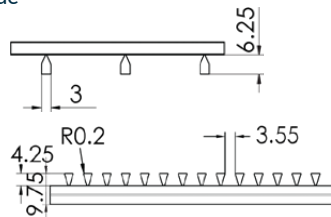

Bottom

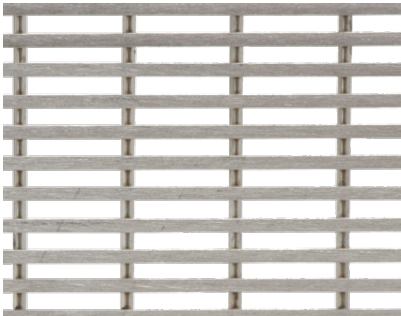
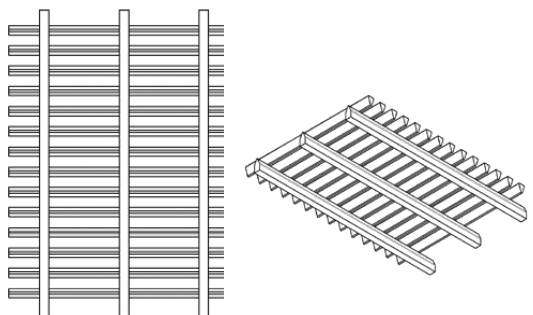

Grates & Drains



Wedge Wire G300



WW-G300-304 (304 grade)

WW-G300-316 (316 grade)

- Wire Size
5.00mmW x 5.00mmH. Gap 5.00mm
- Support Bars
3.00mmW x 12.00mmH. Gap 22.00mm
- Convenient sheet size minimises wastage - 1780mm x 727mm
- 304 or 316 grade stainless steel
- Versatile and long lasting
- Flat bed manufacturing technique - not rolled
- Available off the shelf

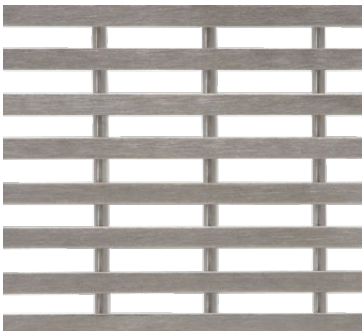
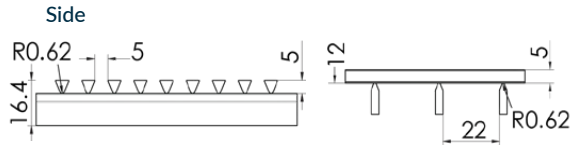
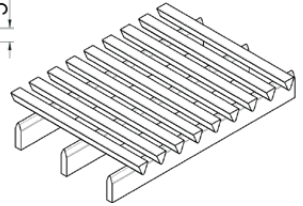
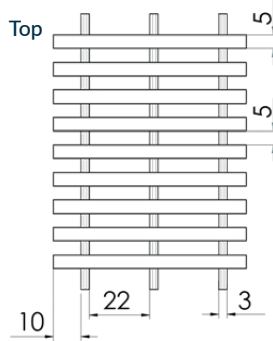

Bottom

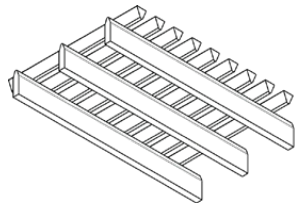



NSW 02 9627 6111

WA 08 6305 0681

TAS 03 6344 7060

VIC 03 9357 6562

SA 0408 299 443

NT 0447 382 658

QLD 07 3881 0322

ACT 0408 446 961

FNQ 07 4775 6956

3monkeez

www.3monkeez.com.au

sales@3monkeez.com.au