

Hardware

For Windows & Doors



The finishing touches

Hardware solutions by AWS.

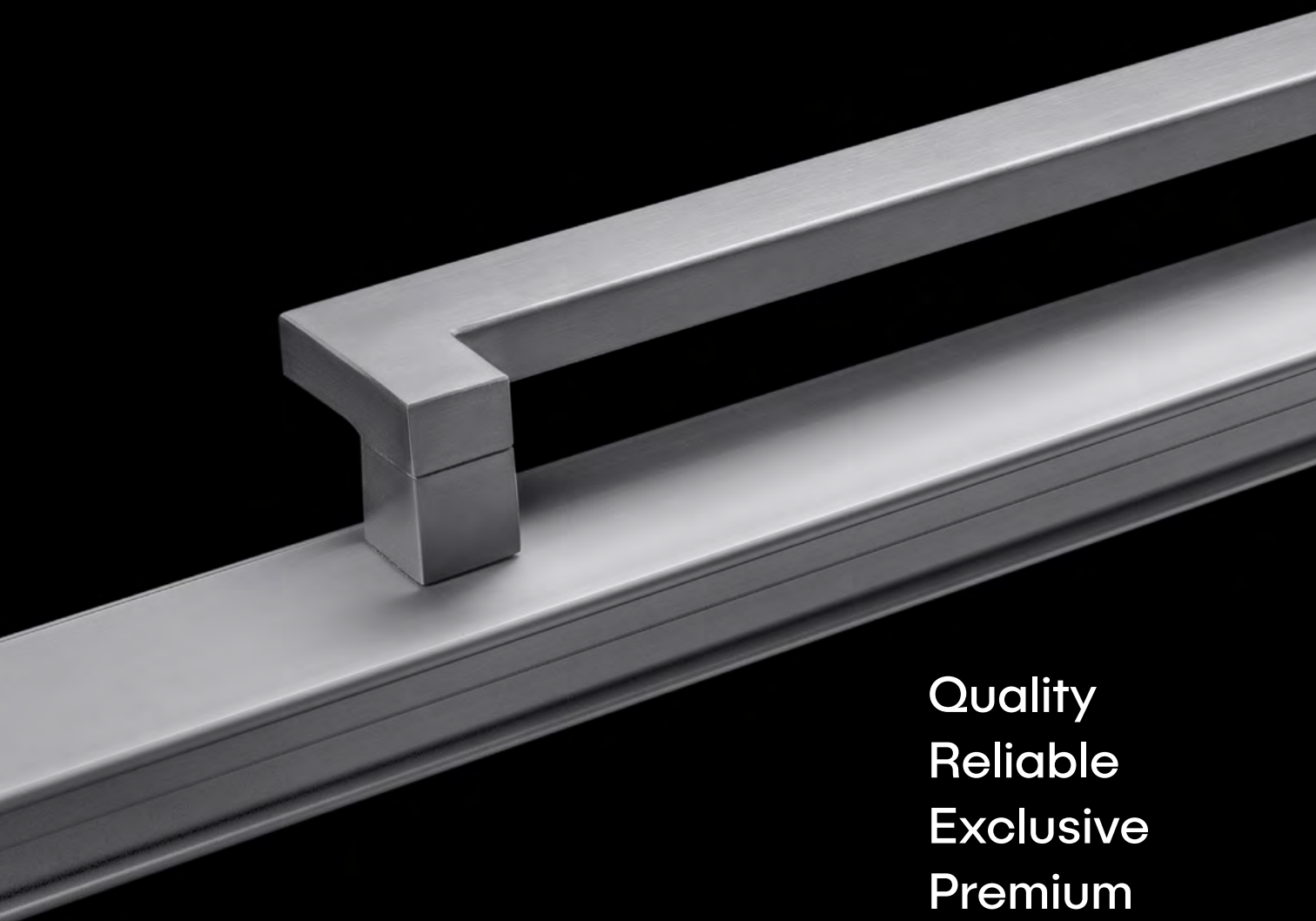

Quality
Reliable
Exclusive
Premium
Functional

Beautiful hardware combines form and function to transform a house into a home. It's a defining feature reflecting who you are.

We offer three unique and stylish suites of purpose-designed hardware to complement the performance and styling of Vantage® and Elevate™ window and door systems.

The right solution is the one that's right for you, and we've been getting it right in Australian homes and commercial applications for more than 25 years.

Contents

Our Ranges	02
Choosing the right hardware	04
ANDO™	06
ICON™	30
MIRO™	46
Additional Hardware Options	66
Hardware Compatibility	78
Colour	81
Care & Maintenance	82
Warranty	83

Our Ranges

Each of our hardware ranges are uniquely styled to offer you a variety of options for your windows and doors.



Form & Function

Crafted to complement the clean, modern design of Vantage® Designer Series windows and doors, the ANDO™ range brings a clean and refined look to your home or commercial project.

ANDO™ is a comprehensive range of hardware that is easily tailored to your needs. It is available in a variety of finishes including colour matched powder coats.



icon



Strength & Integrity

ICON™ is a range of 316-grade stainless steel hardware for aluminium windows and doors. It offers superior weathering performance and outstanding durability, making it suitable for all environments.

Developed for use with our high-performance window and door systems, ICON™ incorporates a square-edged, linear look. It's the perfect finishing touch to complement our Designer or Architectural Series windows and doors.



miro

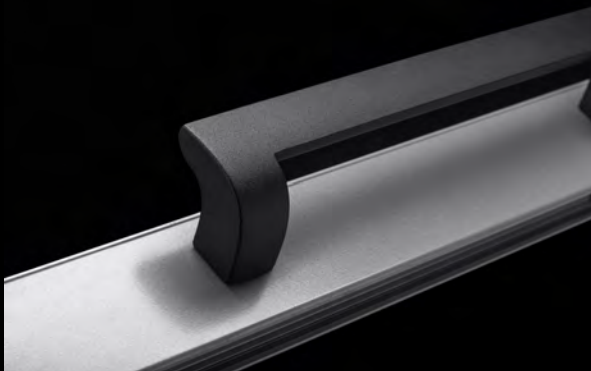

Contemporary Style

MIRO™ hardware offers a textured, matt black, white or silver finish, ergonomic operation for greater accessibility and beautiful curved aesthetics.

Purpose designed for use in harsh environments, the cast aluminium body incorporates our exclusive Enduratec™ finishing technology, tested to deliver 10 times the corrosion resistance of traditional powder coat finishes.

Compatible with Architectural, Residential and Designer Series windows and doors, MIRO™ is an appealing choice for any application.

Choosing the right hardware for your project.

When thinking about hardware selection for your home it is important to consider that the locks and handles you choose will not only provide security but also represent the element of your windows and doors you will interact with most regularly. There are a number of important considerations when selecting hardware for your windows and doors.

Accessibility & Operation

Should the handle or lever be compliant with disability standards to ensure the long-term livability of your home?

If so, AWS offers a number of hardware options which make access for individuals with reduced dexterity easier and a number of options which comply with the requirements for disability access as outlined in AS1428.1-2021 Design for Access.



AS1428.1-2021 Compliant

If AS1428.1-2021 compliance is a priority, look for hardware options marked with this symbol.



Accessibility Focussed

If compliance isn't essential but enhanced accessibility features are important, look for hardware options marked with this symbol.

Colour Matched Finish

Hardware can be a defining statement in your home and the ability to select from a range of colours to complement your internal colour scheme is important.

The ANDO™ range of hardware allows for colour matched options.



Colour Matched

If the ability to colour match your hardware is a priority, choose from hardware items with this symbol.

Bushfire Prone Areas

AWS offers a wide range of window and door systems tested for use in BAL-40 applications. Not all our hardware has been through the testing process.



BAL-40 Tested

If you are building in a BAL-40 application where you wish to use a tested window or door system, select from hardware with this symbol.

Harsh Environments & Coastal Applications

Coastal applications are renowned for having harsh environmental conditions which can impact the long-term integrity of your hardware. AWS offers two hardware ranges which are well suited for use in coastal applications, though neither will be immune to the impacts of this harsh environmental condition.



Enduratec™ Finish Technology

Our unique range of MIRO™ hardware with Enduratec™ Finish Technology is a great solution for areas subjected to harsh environmental conditions, such as coastal applications but where a cost effective and low maintenance solution is preferred.

Hardware coated with Enduratec™ Finish Technology performs up to 10 times better than standard powder coat hardware when tested in a neutral salt bath for corrosion resistance.

The unique Enduratec™ Finish incorporates a stylish matt appearance and requires very little maintenance to keep it looking great. Hardware should be wiped over with a damp cloth or mild soapy water every 3–6 months.

We are so confident about the performance of Enduratec™ coated hardware we are prepared to warrant these items against finish defects even in applications less than 5km from the coast.

E Enduratec™ Finish Technology

If you are looking for hardware items available with Enduratec™ Finish Technology, select from items marked with this symbol.

Stainless Steel Hardware

Stainless steel hardware is our premium offering for use in harsh environmental conditions. Made from 316-grade stainless steel, ICON™ hardware will provide excellent longevity and performance.

Stainless steel is resistant to rust but not immune to it. Stainless steel will rust, commonly identified by the discolouration you might see on stainless steel hardware. This is referred to as tea staining.

Tea staining is discolouration of the surface of stainless steel by corrosion. It is a cosmetic issue that does not affect the structural integrity or the lifetime of the material. Tea staining occurs most commonly within about five kilometres of the surf and becomes progressively worse closer to the marine source.

To minimise the risk of tea staining occurring, hardware must be kept clean and free from contaminants. Monthly cleaning is recommended when living by the coast.

SS Stainless Steel

If you are seeking a premium solution for a coastal or harsh environment application, select hardware items marked with this symbol.



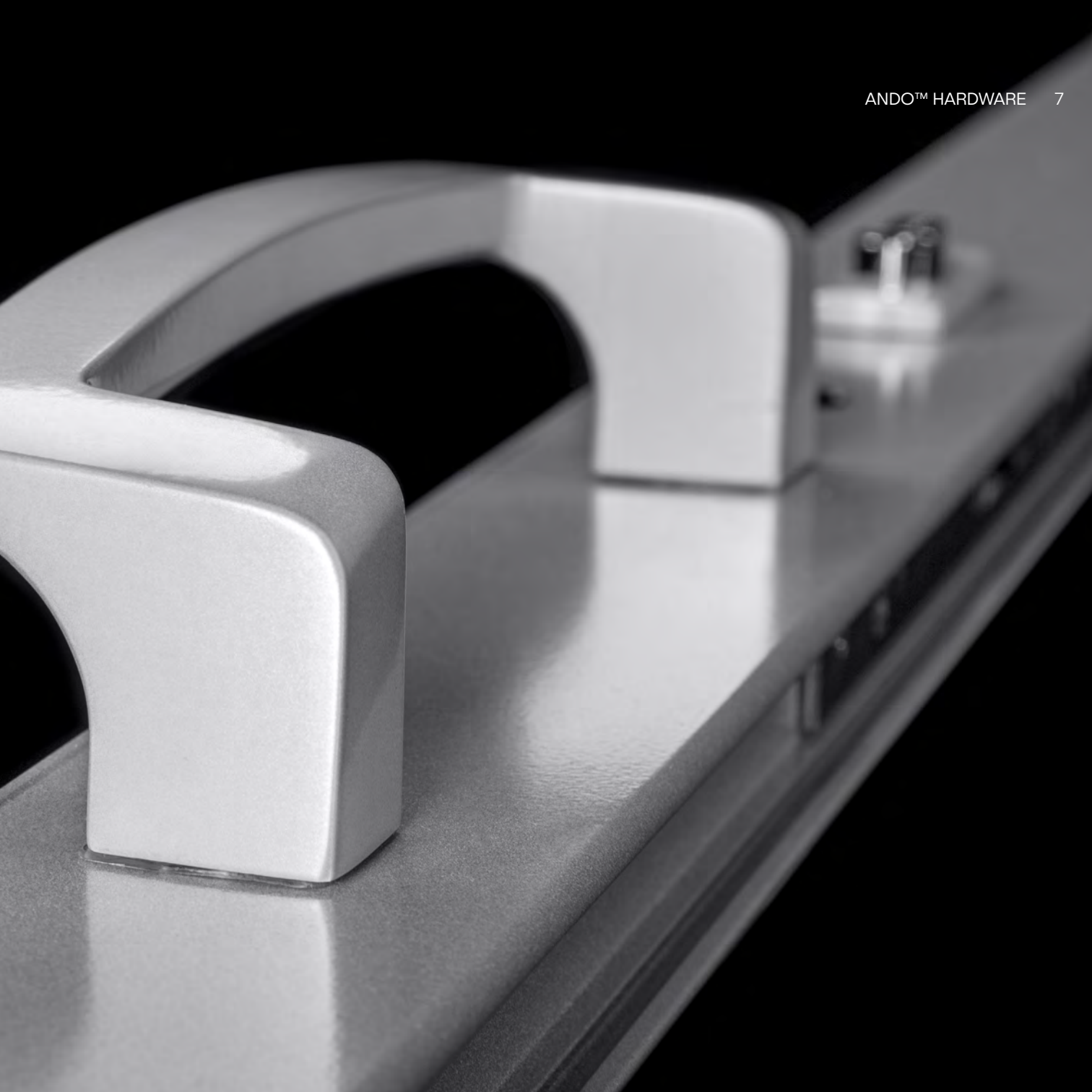

Single Point Sliding Door Lock

Surface-mounted to the door with an integrated single point locking mechanism, this strong and bold handle delivers modern design and clean lines.

Suitable for use with:

- 541** Residential Sliding Door
- 542** Residential Stacking Sliding Door
- 758** High Performance Sliding Door
- 759** ComfortEDGE™ Sliding Door
- 618** MAGNUM™ Sliding Door
- 442** Commercial Stacking Sliding Door
- 642** Commercial Stacking Sliding Door
- 471** Apartment Sliding Door
- 702** SlideMASTER™ Sliding Door (External Sliding)
- 704** SlideMASTER™ Sliding Door (Internal Sliding)

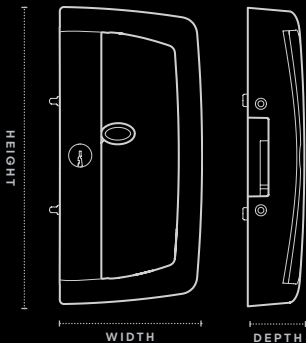

Height 216mm
Width 102.5mm
Depth 41mm
Part 93635



Twin Point Sliding Door Lock

This powerful handle incorporates a twin actuated locking mechanism. Surface-mounted to the door, this handle makes a stylish and highly functional design statement with the added security of 2-point locking.

Suitable for use with:

- 541** Residential Sliding Door
- 542** Residential Stacking Sliding Door*
- 758** High Performance Sliding Door
- 759** ComfortEDGE™ Sliding Door
- 618** MAGNUM™ Sliding Door
- 442** Commercial Stacking Sliding Door*
- 471** Apartment Sliding Door*
- 642** Commercial Stacking Sliding Door*
- 702** SlideMASTER™ Sliding Door (External Sliding)
- 704** SlideMASTER™ Sliding Door (Internal Sliding)
- 704T** SlideMASTER™ Sliding Door (Top Hung)
- 704B** SlideMASTER™ Sliding Door (Bottom Rolling)
- 704R** SlideMASTER™ Sliding Door (Recessed)

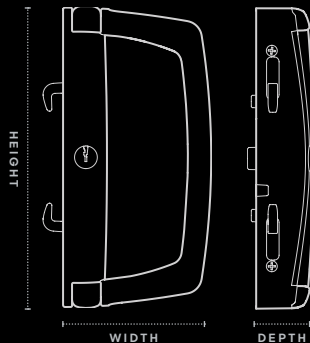

Height 216mm
Width 107mm
Depth 41mm
Part 93689

* if panels are above 2400mm high, the slimline handle must be used.



Slimline Sliding Door Lock

This lock's twin actuated locking mechanism delivers a high performance locking system. There is no lever or D-Pull to protrude over the glass, ensuring clean lines and a sleek appearance.

Suitable for use with:

- | | |
|--|---|
| 541 Residential Sliding Door | 462 Architectural Sliding Window |
| 542 Residential Stacking Sliding Door | 702 SlideMASTER™ Sliding Door (External Sliding) |
| 758 High Performance Sliding Door | 704 SlideMASTER™ Sliding Door (Internal Sliding) |
| 759 ComfortEDGE™ Sliding Door | 704T SlideMASTER™ Sliding Door (Top Hung) |
| 601/2 MAGNUM™ Sliding Window | 704B SlideMASTER™ Sliding Door (Bottom Rolling) |
| 618 MAGNUM™ Sliding Door | 704R SlideMASTER™ Sliding Door (Recessed) |
| 442 Commercial Stacking Sliding Door | |
| 461 Apartment Sliding Window | |
| 642 Commercial Stacking Sliding Door | |
| 471 Apartment Sliding Door | |

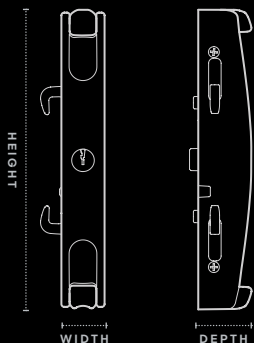

Height 216mm
Width 31.5mm
Depth 38.5mm
Part 93691



 Colour Matched

 Stainless Steel

 BAL-40 Tested

Sliding Door Pull Handle

This elegant D-Pull handle offers a sleek and contemporary alternative to surface-mounted sliding door locks. The large aperture is suitable for a wide range of residential and commercial applications.

This handle is manufactured from 316-grade stainless steel and available in a natural Stainless Steel finish or with colour matched powder coat finish.

Suitable for use with:

- 758** High Performance Sliding Door
- 759** ComfortEDGE™ Sliding Door
- 618** MAGNUM™ Sliding Door
- 50** Commercial Door (Single Beaded)
- 51** Light Commercial Door
- 52** Commercial Door (Double Beaded)
- 702** SlideMASTER™ Sliding Door (External Sliding)
- 704** SlideMASTER™ Sliding Door (Internal Sliding)
- 704R** SlideMASTER™ Sliding Door (Recessed)
- 704B** SlideMASTER™ Sliding Door (Bottom Rolling)
- 704T** SlideMASTER™ Sliding Door (Top Hung)
- 731** Thermally Broken Sliding Door
- 852** Thermally Broken Sliding Door

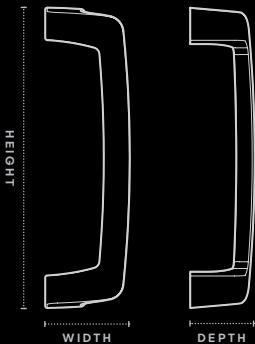

Height 237mm
Width 66.5mm
Depth 50.5mm
Part 93208

NOTE: Available either as stainless steel or with powder coat finish, not both.



CM Colour Matched

SS Stainless Steel

BAL-40 Tested

Hinged Door Lock

A highly versatile lever handle with a clean and compact design.

This hinged door lock is available either as 316-stainless steel or with a powder coat finish.

Available as:

- 2-point lock – single locking Part 93213
- 4-point lock – multi locking Part 93214
- lever compression locking

Suitable for use with:

548 High Performance Bi-fold Door

549 Hinged Entry Door

50 Commercial Door (Single Beaded)

51 Light Commercial Door

52 Commercial Door (Double Beaded)

410 FoldMASTER™ Bi-fold Door (Bottom Rolling)

411 FoldMASTER™ Bi-fold Door (Top Hung)

412 ViewMASTER™ Bi-fold Door (Bottom Rolling)

650 Architectural Hinged Door

729 Thermally Broken Hinged Door

730 Thermally Broken Bi-fold Door (Bottom Rolling)

831 Thermally Broken Bi-fold Door (Top Hung)

832 Thermally Broken Bi-fold Door (Bottom Rolling)

852H Thermally Broken Hinged Door

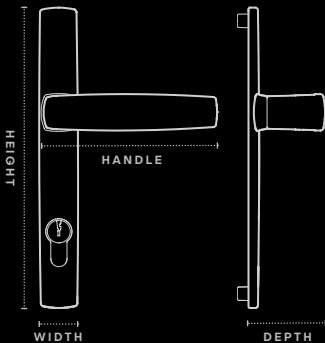

Height 241.5mm
Width 27.5mm
Handle 125mm
Depth 54.5mm

NOTE: Available either as stainless steel or with powder coat finish, not both.



 Colour Matched

 Stainless Steel

 BAL-40 Tested

Bi-fold Operator

The smooth, flush profile offers a discreet yet highly functional operator for use in our bi-fold windows and doors.

It is available with either a powder coat finish or as 316-stainless steel.

This swivel operator pushes locking stainless steel bolts into the frame at the top and bottom of the panel. Separately installed key locking is available upon request.

Suitable for use with:

- 758** High Performance Sliding Door
- 759** ComfortEDGE™ Sliding Door
- 546** High Performance Bi-fold Window (Bottom Rolling)
- 548** High Performance Bi-fold Door (Bottom Rolling)
- 410** FoldMASTER™ Bi-fold Door (Bottom Rolling)
- 411** ViewMASTER™ Bi-fold Door (Top Hung)
- 412** ViewMASTER™ Bi-fold Door (Bottom Rolling)
- 730** Thermally Broken Bi-fold Door (Bottom Rolling)
- 831** Thermally Broken Bi-fold Door (Top Hung)
- 832** Thermally Broken Bi-fold Door (Bottom Rolling)

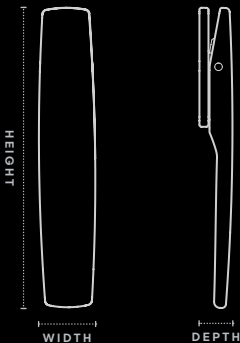

Height 149.5mm

Width 28mm

Depth 16.5mm

Key Lock 93216

Non Keyed 93215

NOTE: Available either as stainless steel or with powder coat finish, not both.



Extruded Pull Handle

The Affixed Pull Handle is surface mounted directly on the glass for a minimalist and sleek design. This allows the frame to be embedded into the structure of the home for greater views and better performance.

Available in colour matched powder coat finish.

Suitable for use with:

758 High Performance Sliding Door

759 ComfortEDGE™ Sliding Door

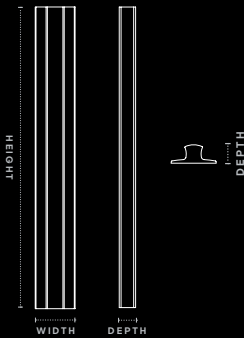

Height 250mm
Width 33mm
Depth 14mm
Part 93852



Sliding Window Lock

A compact and streamlined window lock for a neat, flush finish. Perfect for applications where a minimalist style is desired. Push the operator into the body to slide the window open or closed. Key lockable for security and peace of mind.

Suitable for use with:

752 High Performance Sliding Window

461 Apartment Sliding Window

753 ComfortEDGE™ Sliding Window

462 Architectural Sliding Window

601/2 MAGNUM™ Sliding Window

662 Architectural Sliding Window

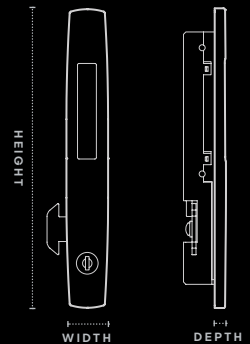

Height 190mm
Width 26.5mm
Depth 7.2mm
Part 93275

Double Hung Lock

A simple and stylish lock for use with double hung windows which can be colour matched for a truly custom finish. Turn the latch to lock and unlock. Available in non-keyed or keyed finish for added security.

Suitable for use with:

- 514** Residential Double Hung Window
- 613** MAGNUM™ Double Hung Window
- 453** Commercial Double Hung Window
- 463** Architectural Double Hung Window

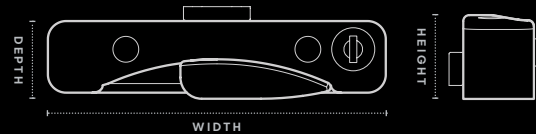

Height	28mm		
Width	114mm	Key Lock	93672
Depth	25.5mm	Non Keyed	93671



SS Stainless Steel

BAL-40 Tested

Recessed Finger Pull

This alternative to a sliding door or window handle offers a more understated look.

Available in stainless steel finish only.

Suitable for use with:

- 758** High Performance Sliding Door
- 759** ComfortEDGE™ Sliding Door
- 618** MAGNUM™ Sliding Door
- 50** Commercial Door (Single Beaded)
- 52** Commercial Door (Double Beaded)
- 702** SlideMASTER™ Sliding Door (External Sliding)
- 704** SlideMASTER™ Sliding Door (Internal Sliding)
- 731** Thermally Broken Sliding Door
- 852S** Thermally Broken Sliding Door

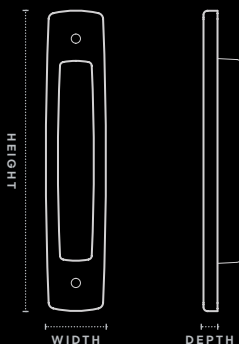

Height 150mm

Width 30mm

Depth 7mm

Part 93194



Manual Chainwinder

The ANDO™ Manual Chainwinder is designed to suit Vantage® residential awning window systems and Elevate™ commercial awning window systems.

Incorporating a corrosion resistant Polesium™ body and adjustable 316-grade stainless steel chain, the ANDO™ Manual Chainwinder delivers a reliable and stylish solution which can be colour matched to the custom powder coat finish of your new windows.

The indicator allows you to see whether the winder is locked or unlocked at a glance.

Integrated within the body is a Safe4Kids™ restriction option that limits how wide the window can open to minimise the risk of falls.

Suitable for use with:

- 516 Residential Awning Window
- 517 Residential Awning Window
- 756 High Performance Awning Window
- 755 ComfortEDGE™ Awning Window
- 616 MAGNUM™ Awning Window
- 456 Commercial Awning Window
- 466 Architectural Awning Window
- 726 Thermally Broken Awning Window



Height 41mm
Width 278mm
Depth 45mm
Part 93076





Twin Chainwinder

The Ando™ Twin Chainwinder delivers a reliable and durable solution to even our largest awning window systems. The wider span allows greater flexibility in awning window design.

Integrated within the body is a Safe4Kids™ restriction option that limits how wide the window can open to minimise the risk of falls.

Available in colour matched powder coat finish.

Suitable for use with:

- 516 Residential Awning Window
- 517 Residential Awning Window
- 756 High Performance Awning Window
- 755 ComfortEDGE™ Awning Window
- 616 MAGNUM™ Awning Window
- 456 Commercial Awning Window
- 665 Commercial Awning Window
- 466 Architectural Awning Window
- 726 Thermally Broken Awning Window

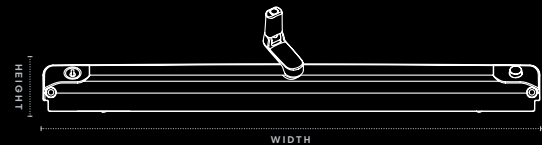

Height 33mm
Width 475mm
Depth 46mm
Part 93118







Strength & Integrity

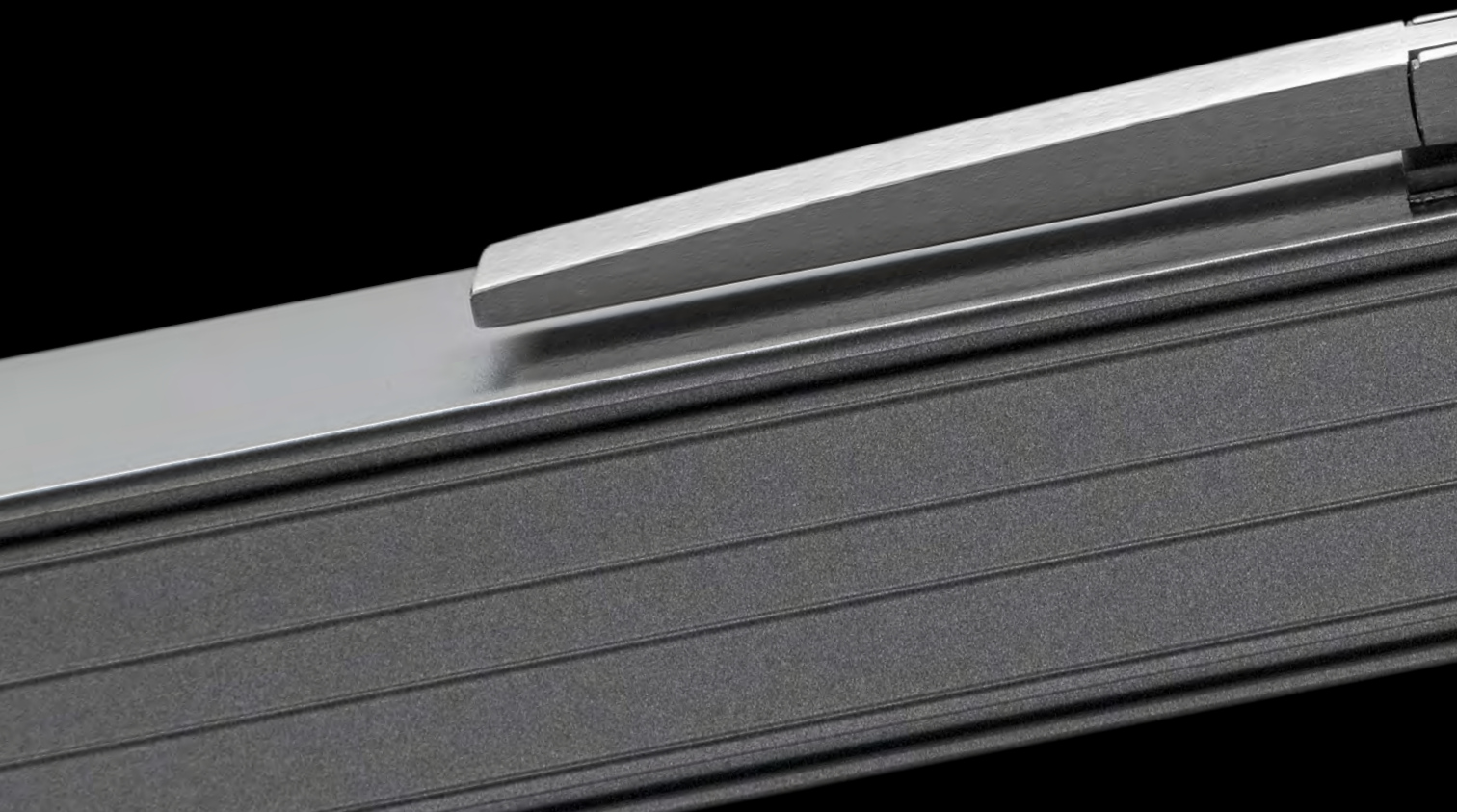



Sliding Door Handle

This handle makes a real statement. Its square form offers a firm yet comfortable grip and is ideal for larger sliding door panels in residential and commercial applications.

Manufactured from 316-grade stainless steel, this handle is ideal for use in harsh environmental applications and high traffic areas.

Available in two lengths: 325mm and 630mm.

Suitable for use with:

- 758 High Performance Sliding Door
- 759 ComfortEDGE™ Sliding Door
- 618 MAGNUM™ Sliding Door
- 702 SlideMASTER™ Sliding Door (External Sliding)
- 704 SlideMASTER™ Sliding Door (Internal Sliding)
- 704R SlideMASTER™ Sliding Door (Recessed)
- 704B SlideMASTER™ Sliding Door (Bottom Rolling)
- 704T SlideMASTER™ Sliding Door (Top Hung)
- 731 Thermally Broken Sliding Door
- 852S Thermally Broken Sliding Door

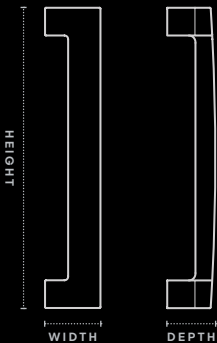

Height 325mm
Width 60mm
Depth 52mm
Part 93178



Height 630mm
Width 60mm
Depth 52mm
Part 93230



Optional: Thumb Turn. Offers a quick and easy locking solution, providing instant security without compromising safety. Locks from the inside, no need to search for key to unlock, simply rotate.

Part 93539



Hinged Door Lock

A clean and compact hinged door handle available in:

- 2-point lock – single locking
Part 93458
- 4-point lock – multi locking
Part 93470
- lever compression locking

The 4-point lever compression option activates additional locking rods at the top and bottom of the door.

This mechanism allows door panels to seal tightly and securely, increasing airtightness and improving energy efficiency.

The grip has a gently radiused front face and a curved back for a comfortable hand-hold.

The ICON™ Hinged Door Lock is highly durable and tested for use with large residential and commercial hinged door applications.

Suitable for use with:

548	High Performance Bi-fold Door	730	Thermally Broken Bi-fold Door
549	Hinged Entry Door	831	Thermally Broken Bi-fold Door (Top Hung)
50	Commercial Door (Single Beaded)	832	Thermally Broken Bi-fold Door (Bottom Rolling)
51	Light Commercial Door	852	Thermally Broken Hinged Door
52	Commercial Door (Double Beaded)		
410	FoldMASTER™ Bi-fold Door (Bottom Rolling)		
411	FoldMASTER™ Bi-fold Door (Top Hung)		
412	ViewMASTER™ Bi-fold Door (Bottom Rolling)		
650	Architectural Hinged Door		
729	Thermally Broken Hinged Door		

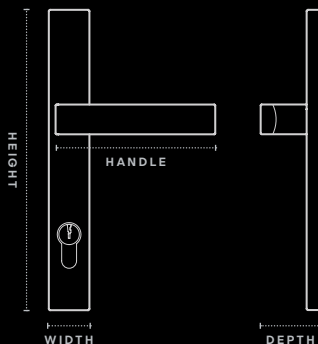

Height 222mm

Width 30mm

Handle 118mm

Depth 44mm



Bi-fold Operator

This swivel operator pushes stainless steel locking bolts into the frame at the top and bottom of the panel. The square corners of the handle are combined with radiused top and bottom surfaces to soften the aesthetics.

Suitable for use with:

- 546** High Performance Bi-fold Window
- 548** High Performance Bi-fold Door
- 410** FoldMASTER™ Bi-fold Door (Bottom Rolling)
- 411** FoldMASTER™ Bi-fold Door (Top Hung)
- 412** ViewMASTER™ Bi-fold Door (Bottom Rolling)
- 730** Thermally Broken Bi-fold Door
- 831** Thermally Broken Bi-fold Door (Top Hung)
- 832** Thermally Broken Bi-fold Door (Bottom Rolling)

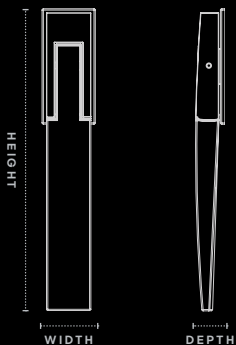

Height 170mm

Width 25mm

Depth 16.5mm

Key Lock 93199

Non Keyed 93198



Casement Latch

Designed to suit residential awnings and casement windows, the main features of this latch are its bold square edges and radiused styling.

The 316-grade stainless steel makes it a classy and superior quality selection for use in coastal locations.

Suitable for use with:

- 516 Residential Awning/Casement Window
- 517 Residential Awning/Casement Window
- 616 MAGNUM™ Awning/Casement Window
- 456 Commercial Awning/Casement Window
- 466 Architectural Awning/Casement Window
- 726 Thermally Broken Awning/Casement Window

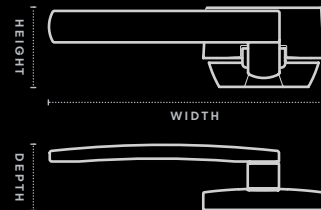
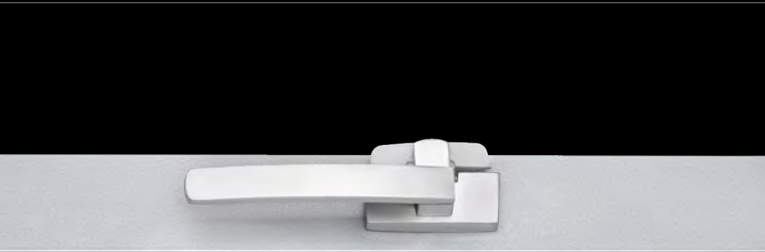

Height 37.2mm
Width 131mm RH Part 93147
Depth 31mm LH Part 93148



Recessed Flush Pull

An ideal choice for a more minimalist finish where understated hardware is preferred. Flush pulls are an excellent choice where consideration is needed around drapes and blinds.

Suitable for use with:

- 758** High Performance Sliding Door
- 759** ComfortEDGE™ Sliding Door
- 618** MAGNUM™ Sliding Door
- 702** SlideMASTER™ Sliding Door (External Sliding)
- 704** SlideMASTER™ Sliding Door (Internal Sliding)
- 704R** SlideMASTER™ Sliding Door (Recessed)
- 704B** SlideMASTER™ Sliding Door (Bottom Rolling)
- 704T** SlideMASTER™ Sliding Door (Top Hung)
- 50S** Commercial Sliding Door (Single Beaded)
- 52S** Commercial Sliding Door (Double Beaded)
- 731** Thermally Broken Sliding Door
- 852S** Thermally Broken Sliding Door

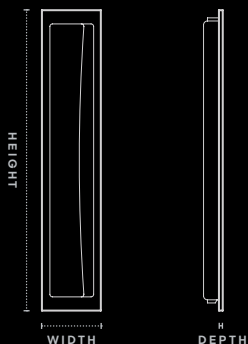

Height 230mm

Width 45mm

Depth 3mm

RH Part 93196

LH Part 93195

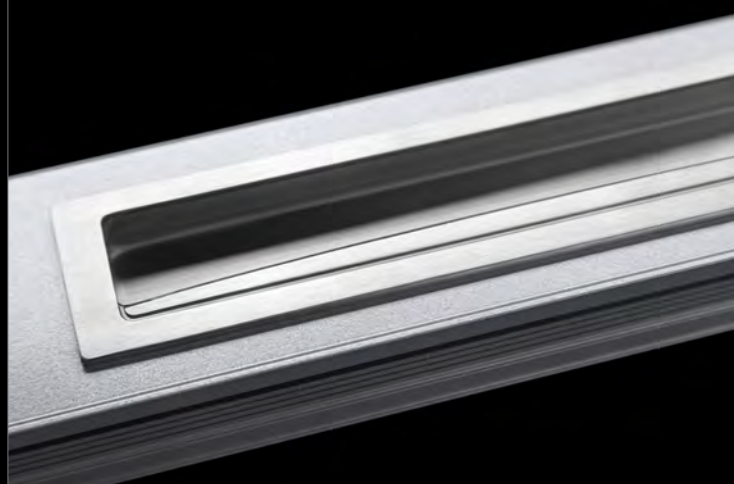
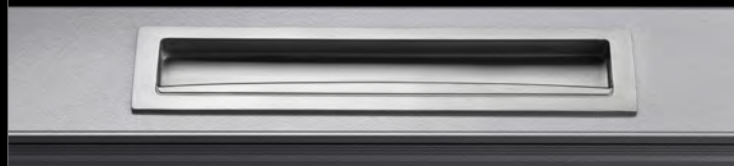

 Stainless Steel



 BAL-40 Tested

Sliding Window Lock

A compact, streamlined window lock for a neat, flush finish. Push operator into body to slide window open or closed. Key lockable for security and peace of mind.

Suitable for use with:

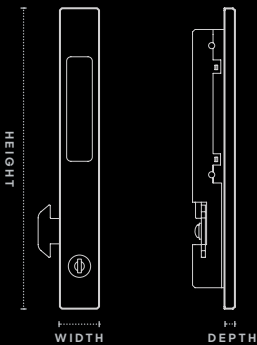
- 752** High Performance Sliding Window
- 601** MAGNUM™ Sliding Window (Beaded Fixed Light)
- 602** MAGNUM™ Sliding Window (Double Sash Design)
- 461** Apartment Sliding Window
- 462** Architectural Sliding Window
- 662** Architectural Sliding Window (150mm)



Height 160mm
Width 24mm
Depth 6.5mm
Part 93274

NOTE: Not suitable for FXXF window configurations.



ISEO Mortice Lock

Designed specifically for high-end sliding doors, the flush face plate ensures seamless stacking with no obstruction or interference.

This key lockable mortice lock and finger pull is an ideal choice for cavity sliding door applications.

Suitable for use with:

- 758** High Performance Sliding Door
- 759** ComfortEDGE™ Sliding Door
- 618** MAGNUM™ Sliding Door
- 704** SlideMASTER™ Sliding Door (Internal Sliding)
- 704R** SlideMASTER™ Sliding Door (Recessed)
- 704B** SlideMASTER™ Sliding Door (Bottom Rolling)
- 704T** SlideMASTER™ Sliding Door (Top Hung)

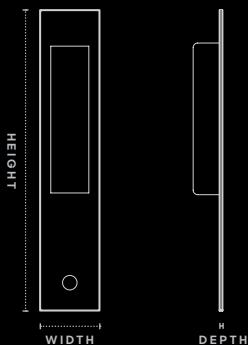

Height 165mm

Width 32mm

Depth 1.5mm

Part 93209



The conveniently located hidden finger pull allows the panel to be pulled out for operation.

Part 93210



Contemporary Style

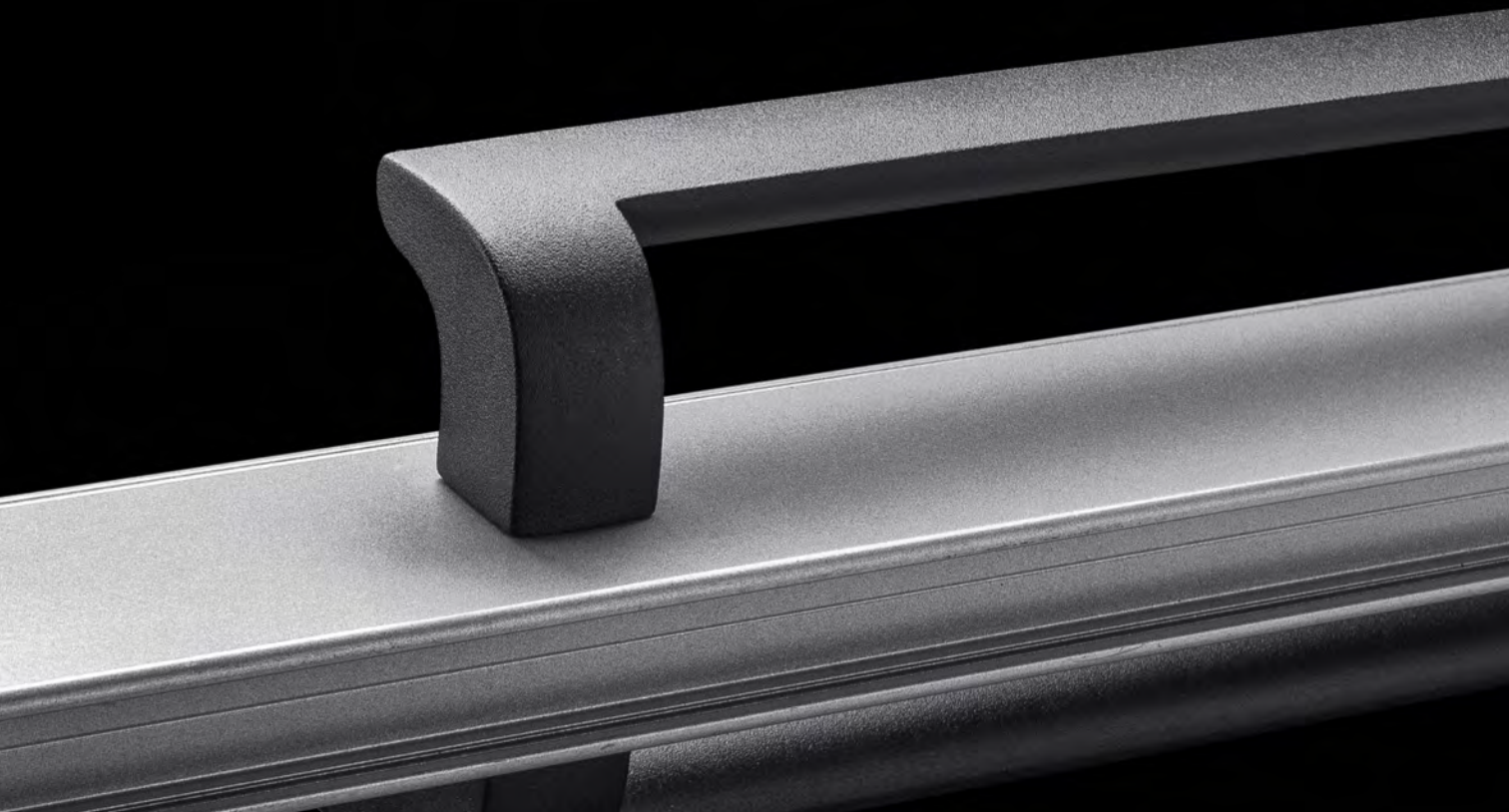



D-Pull Sliding Door Handle

Bold and stylish, the MIRO™ sliding door handle offers simplicity and practicality with its soft rounded edges. The handle is disability access compliant.

Featuring Enduratec™ Finish Technology, it's extremely durable, minimising fingerprints and scratches. Ideal in coastal areas. Available in black, white and silver.

Suitable for use with:

- 758** High Performance Sliding Door
- 759** ComfortEDGE™ Sliding Door
- 618** MAGNUM™ Sliding Door
- 50** Commercial Door (Single Beaded)
- 51** Light Commercial Door
- 52** Commercial Door (Double Beaded)
- 702** SlideMASTER™ Sliding Door (External Sliding)
- 704** SlideMASTER™ Sliding Door (Internal Sliding)
- 704R** SlideMASTER™ Sliding Door (Recessed)
- 704B** SlideMASTER™ Sliding Door (Bottom Rolling)
- 704T** SlideMASTER™ Sliding Door (Top Hung)
- 731** Thermally Broken Sliding Door
- 852S** Thermally Broken Sliding Door

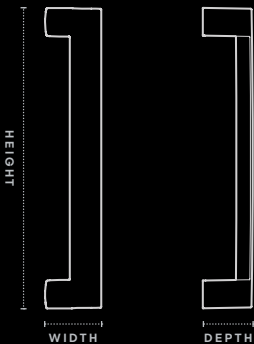

Height 325mm

Width 61mm

Depth 54mm

Part 92020



Single Point Sliding Door Lock

Bold in design with modern, curved lines, the MIRO™ Sliding Door Lock mounts on the door and offers an integrated single point lock, delivering a solid and functional statement to any surrounding.

The textured matt exterior and Enduratec™ Finish Technology make it simple to use and maintain as well as a perfect choice for harsh environments. Available in black, white and silver.

Suitable for use with:

- 541** Residential Sliding Door
- 542** Residential Stacking Sliding Door
- 758** High Performance Sliding Door
- 759** ComfortEDGE™ Sliding Door
- 618** MAGNUM™ Sliding Door
- 442** Commercial Stacking Sliding Door
- 642** Commercial Stacking Sliding Door
- 471** Apartment Sliding Door
- 704** SlideMASTER™ Sliding Door (Internal Sliding)
- 704R** SlideMASTER™ Sliding Door (Recessed)
- 704B** SlideMASTER™ Sliding Door (Bottom Rolling)
- 704T** SlideMASTER™ Sliding Door (Top Hung)

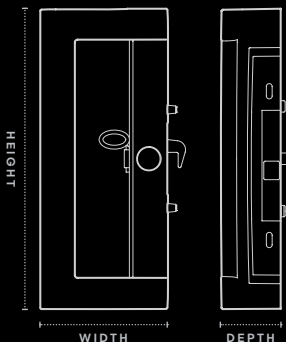

Height 235mm
Width 100mm
Depth 47mm

Part 92025



Hinged Door Lock

With its contemporary curved styling, this handle has an elegant return for smooth operation.

Not only stylish, the handle is disability access compliant and uses Enduratedec™ Finish Technology to maximise durability and simplicity.

Available as:

- 2-point lock – single locking
Part 92001
- 4-point lock – multi locking
Part 92002
- lever compression locking

Available in black, white and silver.

Suitable for use with:

- 548** High Performance Bi-fold Door
- 549** Hinged Entry Door
- 50** Commercial Door (Single Beaded)
- 51** Light Commercial Door
- 52** Commercial Door (Double Beaded)
- 410** FoldMASTER™ Bi-fold Door (Bottom Rolling)
- 411** FoldMASTER™ Bi-fold Door (Top Hung)
- 412** ViewMASTER™ Bi-fold Door (Bottom Rolling)
- 650** Architectural Hinged Door
- 729** Thermally Broken Hinged Door
- 730** Thermally Broken Bi-fold Door
- 831** Thermally Broken Bi-fold Door (Top Hung)
- 832** Thermally Broken Bi-fold Door (Bottom Rolling)
- 852** Thermally Broken Hinged Door

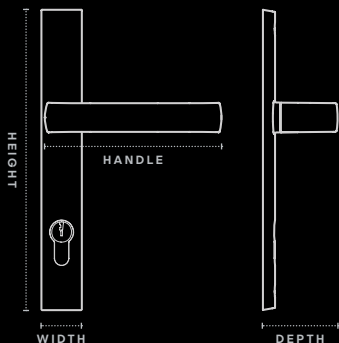

Height 223mm
Width 56mm
Handle 134mm
Depth 56mm



Bi-fold Operator

The contemporary design and matt black styling offers a clean and functional finish for bi-fold windows and doors.

The simplicity of the design coupled with its incorporation of Enduratec™ Finish Technology makes it durable and easy to maintain.

Available in black, white and silver.

Suitable for use with:

- 546** High Performance Bi-fold Window
- 548** High Performance Bi-fold Door
- 410** FoldMASTER™ Bi-fold Door (Bottom Rolling)
- 411** FoldMASTER™ Bi-fold Door (Top Hung)
- 412** ViewMASTER™ Bi-fold Door (Bottom Rolling)
- 730** Thermally Broken Bi-fold Door
- 831** Thermally Broken Bi-fold Door (Top Hung)
- 832** Thermally Broken Bi-fold Door (Bottom Rolling)

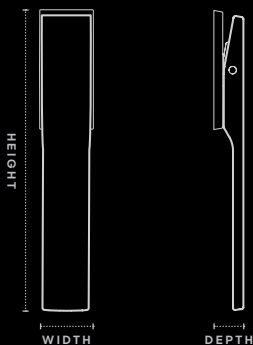

Height 149mm

Width 27mm

Depth 15mm

Key Lock 92009

Non Keyed 92008

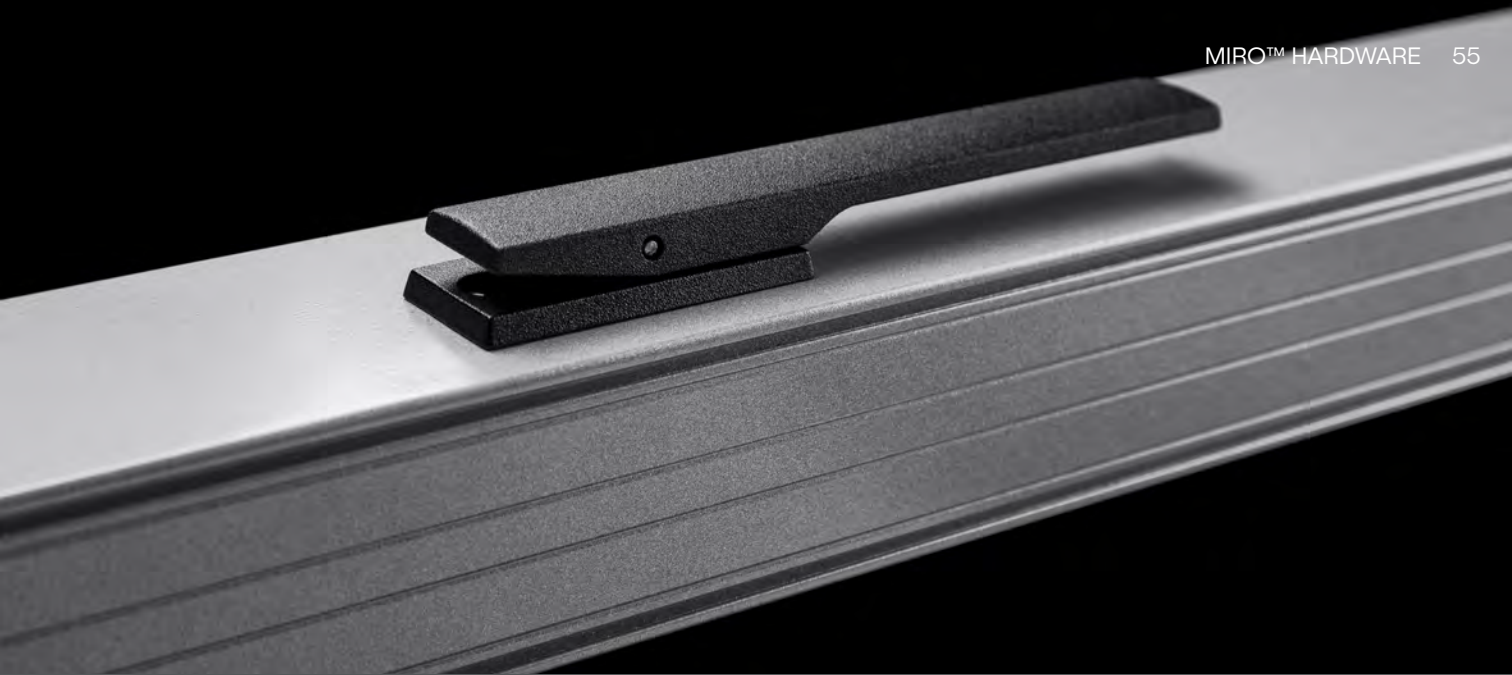

Recessed Flush Pull

A sleek, understated addition to your sliding door, the MIRO™ Recessed Flush Pull incorporates a gently curved faceplate with scalloped highlights.

The recessed pull enables easy door operation without interfering with blinds or curtains.

Available in black, white and silver.

Suitable for use with:

- 758** High Performance Sliding Door
- 759** ComfortEDGE™ Sliding Door
- 618** MAGNUM™ Sliding Door
- 702** SlideMASTER™ Sliding Door (External Sliding)
- 704** SlideMASTER™ Sliding Door (Internal Sliding)
- 704R** SlideMASTER™ Sliding Door (Recessed)
- 704B** SlideMASTER™ Sliding Door (Bottom Rolling)
- 704T** SlideMASTER™ Sliding Door (Top Hung)
- 731** Thermally Broken Sliding Door
- 852S** Thermally Broken Sliding Door

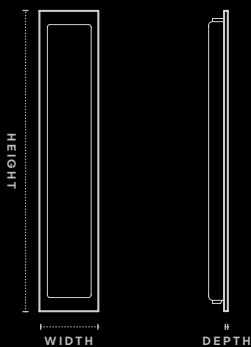

Height 230mm

Width 45mm

Depth 2mm

Part 92038



Sliding Window Lock

A compact, streamlined window lock with recessed finger grab for a neat, flush finish. Push handle tab into body to slide window open or closed. Key lockable for security and peace of mind. Matt finish with Enduratec™ Finish Technology delivers up to 10 times the corrosion resistance compared to traditional powder coating.

Available in black, white and silver.

Suitable for use with:

- 752** High Performance Sliding Window
- 601** Designer Sliding Window
- 602** Designer Sliding Window
- 461** Apartment Sliding Window
- 462** Architectural Sliding Window
- 662** Architectural Sliding Window

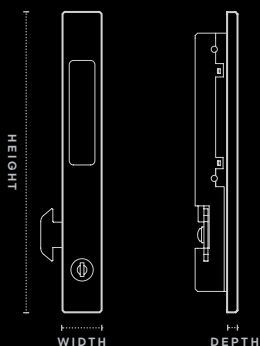

Height 190mm

Width 24mm

Depth 7mm

Part 92039



Single Chainwinder

Featuring a textured matt finish and AWS' exclusive Enduratec™ Finish Technology, this is the ideal solution for use in harsh environmental applications. Incorporating a key lock system and indicator, the indicator allows you to see whether the winder is locked or unlocked at a glance.

Integrated within the body is a Safe4Kids™ restriction option that limits how wide the window can open to minimise the risk of falls.

Available in black, white and silver.

Suitable for use with:

516	Residential Awning Window
517	Residential Awning Window
756	High Performance Awning Window
755	ComfortEDGE™ Awning Window
616	MAGNUM™ Awning Window
456	Commercial Awning Window
665	Commercial Awning Window
466	Architectural Awning Window
726	Thermally Broken Awning Window



Height 41mm
Width 278mm
Depth 45mm
Part 93076

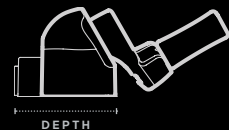



 Accessibility Focused



Optional Special Access Lever (SAL) handle available to improve operability for those with reduced dexterity and to comply with AS1428:2021 Section 13.5 (Disability Access) and Livable Housing Guidelines.

Part 93084

Twin Chainwinder

The MIRO™ Twin Chainwinder delivers a reliable and durable solution for even our largest awning window systems. The wider span allows greater flexibility in awning window design.

Like the MIRO™ Single Chainwinder, it incorporates Enduratec™ technology to maximise durability and capability in coastal applications and other harsh environmental conditions.

Available in black, white and silver.

Suitable for use with:

- 516 Residential Awning Window
- 517 Residential Awning Window
- 756 High Performance Awning Window
- 755 ComfortEDGE™ Awning Window
- 616 MAGNUM™ Awning Window
- 456 Commercial Awning Window
- 665 Commercial Awning Window
- 466 Architectural Awning Window
- 726 Thermally Broken Awning Window



Height 34.5mm
Width 499.5mm
Depth 48mm
Part 93118

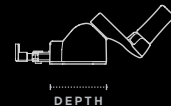



 Accessibility Focused



Optional Special Access Lever (SAL) handle available to improve operability for those with reduced dexterity and to comply with AS1428:2021 Section 13.5 (Disability Access) and Livable Housing Guidelines.

Part 93123





MIRO™ HARDWARE COLOUR RANGE 65

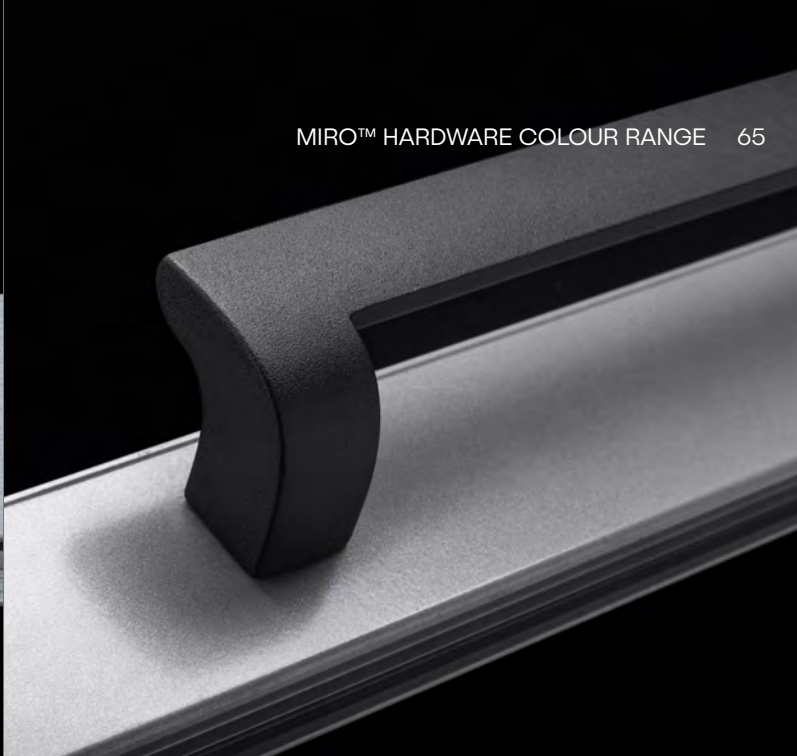

Additional Hardware Options



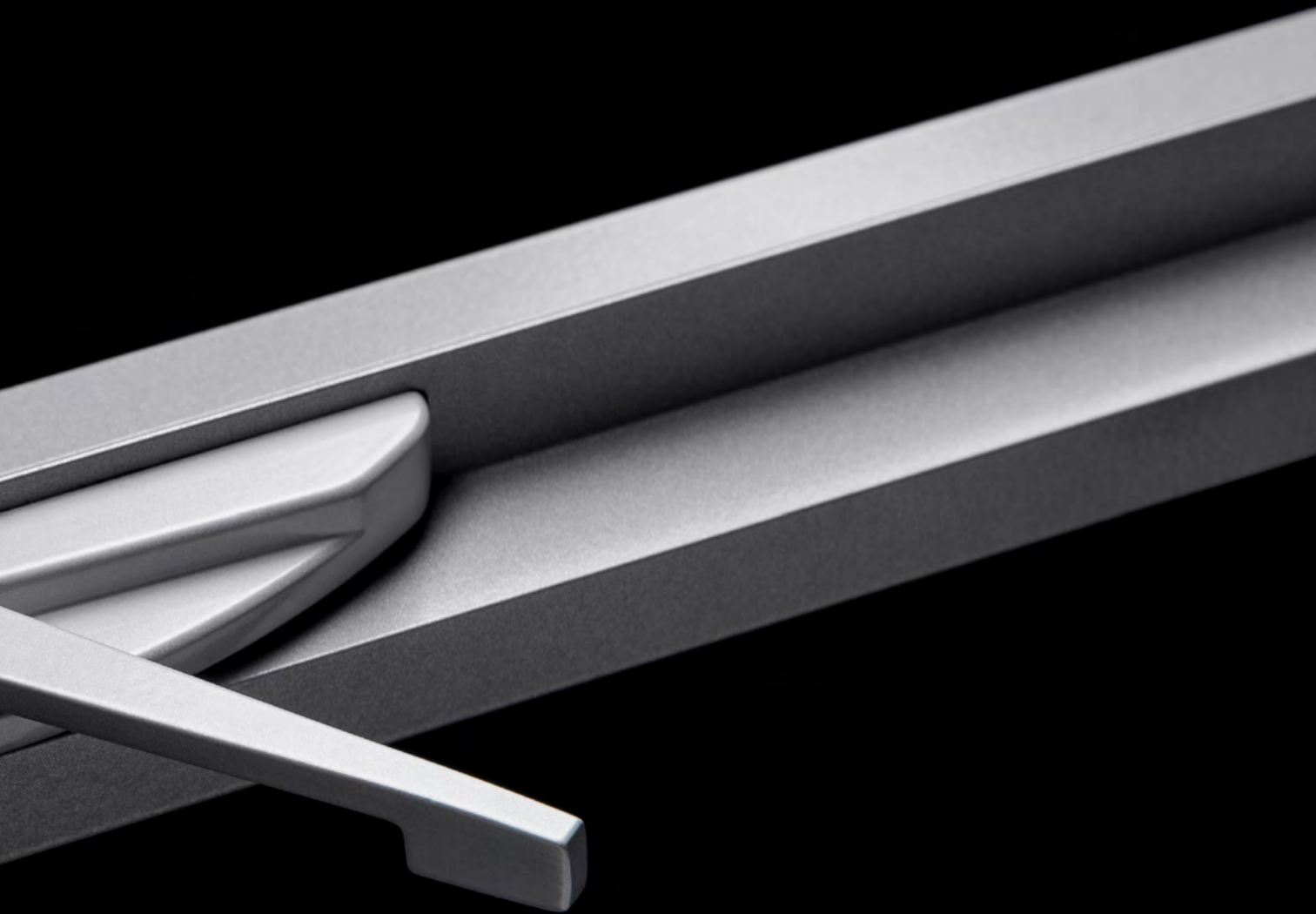

Truth™ Awning Winder

Truth™ compact awning scissor winders are perfect for large awning windows. Tried and tested, Truth™ winders are strong and won't budge under wind load.

Available in a selected range of colours, off-white, black and silver.

Suitable for use with:

- 616** MAGNUM™ Awning/Casement Window
- 467** Architectural Awning/Casement Window
- 468** Truth™ Awning Window/Casement
- 668** Truth™ Awning Window/Casement
- 726** Thermally Broken Awning/Casement Window



Winder (pictured)
Part 93781

Height 34mm
Width 135mm
Depth 40mm

Winder (keyed)
Part 93529

Height 34mm
Width 170mm
Depth 37mm





Key locking version also available.

Truth™ Casement Winder

The Truth™ Casement Winder is a compact and stylish scissor winder ideal for large casement windows and offers 90-degree opening. This winder has been rigorously tested and won't open or close under wind load.

Available in off-white, black and silver.

Suitable for use with:

- 616** MAGNUM™ Awning/Casement Window
- 467** Architectural Awning/Casement Window
- 468** Truth™ Awning Window/Casement
- 668** Truth™ Awning Window/Casement
- 726** Thermally Broken Awning/Casement Window

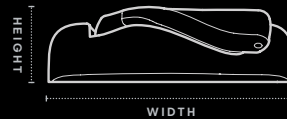

Winder (pictured)

Height 34mm

Width 135mm

Depth 40mm



Winder (keyed)

Height 34mm

Width 170mm

Depth 37mm

RH Part 93784

LH Part 93783



Key locking version also available.





Meeting Stile Mortice Lock

Designed exclusively for use with the Elevate™ range of SlideMASTER™ flush finish doors, the Meeting Stile Mortice Lock integrates neatly into a central panel to be fully concealed for maximum glass sight lines.

The simple operating method provides ease of use and multi-point locking for excellent security.

Available in a range of powder coat finishes to ensure the lock can be colour matched for a truly discreet appearance.

Exclusively used with:

- 758** High Performance Sliding Door
- 759** ComfortEDGE™ Sliding Door
- 704FBR** SlideMASTER™ Sliding Door (Flush Bottom Rolling)
- 704FTH** SlideMASTER™ Sliding Door (Flush Top Hung)

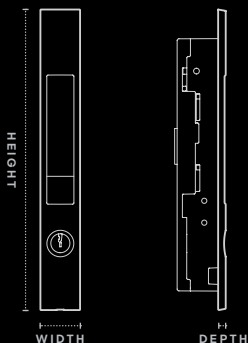

Height 250mm

Width 33mm

Depth 6.5mm

Part 93796





Flush Stile Pull Handle

Architecturally inspired, the Flush Stile Pull Handle is designed exclusively for use with the Elevate range of SlideMASTER™ flush finish doors.

The colour matched, aluminium pull handle provides a strong D-Pull grip which nests neatly around the panel for a minimal and integrated appearance.

Exclusively used with:

704FBR SlideMASTER™ Sliding Door (Flush Bottom Rolling)

704FTH SlideMASTER™ Sliding Door (Flush Top Hung)

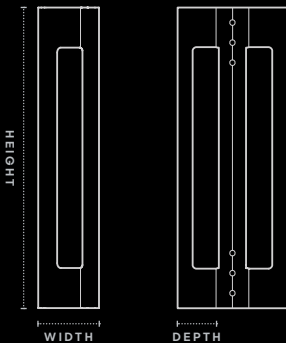

Height 300mm

Width 60.5mm

Depth 40mm

Part 93799





Lift Slide Handle

Designed exclusively for use with the Elevate™ SlideMASTER™ Lift Slide Door, the handle utilises a 180° operating arc to activate lift mechanisms within the sliding door panel for effortless operation. Reverse rotation compresses the panel against the door seals for security and airtightness.

The clean, sharp styling of the handle allows it to integrate with the ICON™ hardware range when coordinating the hardware selection for your home.

Available in black, white and brushed silver.

Exclusively used with:

704LS SlideMASTER™ Sliding Door (Lift Slide)

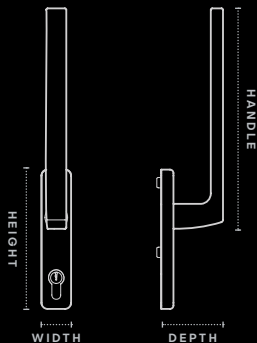

Handle 253mm

Height 160mm

Width 34mm

Depth 71mm

Part 93534





Shown in brushed silver.



Performance Side Latch

Used in conjunction with the single or twin manual chainwinders, performance latches add additional locking points for awning windows.

They may be recommended by your fabricator for applications subjected to high wind loads or in situations where awning windows are wide and require additional locking points to provide security and integrity.

Suitable for use with:

516 Residential Awning Window (50mm)

517 Residential Awning Window (102mm)

756 High Performance Awning Window

616 MAGNUM™ Awning Window

456 Commercial Awning Window

665 Commercial Awning Window

466 Architectural Awning Window

726 Thermally Broken Casement Window

804 Thermally Broken Casement Window

824 Thermally Broken Casement Window

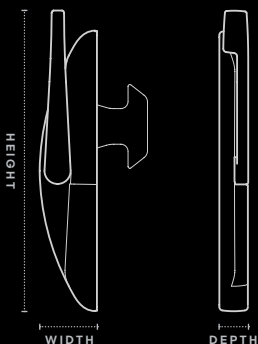

Height 157.5mm

Width 32mm

Depth 16mm

Part 93112



Sliding Window Handle Lock

A reliable classic, the Sliding Window Handle Lock is designed with curved lines for comfort and ease.

Available in black only.

Suitable for use with:

752 High Performance Sliding Window

753 ComfortEDGE™ Sliding Window

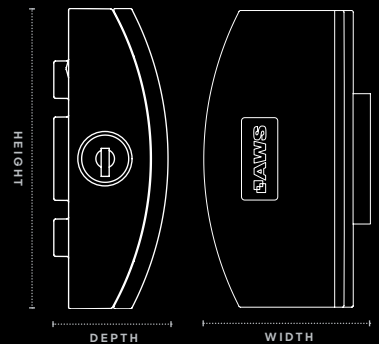

Height 90mm
Width 51mm
Depth 30mm

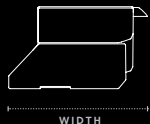

Part 94614

ANDO™

	462	463	466	467	468	668	410	411	412	650	662	701	702	704	T	B	R	LS	FTH	FBR
Single Point Sliding Door Lock													●	●						
Twin Point Sliding Door Lock													●	●	●	●	●			
Slimline Sliding Door Lock													●	●						
Sliding Door Handle													●	●	●	●	●			
Hinged Door Lock (2-point)							●	●	●	●										
Hinged Door Lock (4-point)							●	●	●	●										
Lever Compression Lock							●	●	●	●										
Bi-fold Operator							●	●	●											
Extruded Pull Handle																				
Sliding Window Lock	●											●	●							
Double Hung Lock		●																		
Recessed Finger Pull													●	●						
Manual Chainwinder			●																	
Twin Chainwinder			●																	
Sliding Window Lock	●										●									

ICON™

Sliding Door Handle													●	●	●	●	●			
Hinged Door Lock (2-point)							●	●	●	●										
Hinged Door Lock (4-point)							●	●	●	●										
Lever Compression Lock							●	●	●	●										
Bi-fold Operator							●	●	●											
Casement Latch			●																	
Recessed Flush Pull													●	●	●	●	●			
Sliding Window Lock	●											●	●							
ISEO Mortice Lock														●	●	●	●			

MIRO™

D-Pull Sliding Door Handle													●	●	●	●	●			
Single Point Sliding Door Lock														●	●	●	●			
Hinged Door Lock							●	●	●	●										
Lever Compression Lock							●	●	●	●										
Bi-fold Operator							●	●	●											
Recessed Flush Pull												●	●	●	●	●	●			
Single Chainwinder			●																	
Twin Chainwinder			●																	
Sliding Window Lock	●										●									

Truth™ Winder			●	●	●															
Truth™ Casement Winder			●	●	●															
Meeting Stile Mortice Lock																		●	●	
Flush Pull Handle																		●	●	
Lift Slide Handle																		●		
Performance Side Latch			●																	
Sliding Window Handle Lock																				

Colour

ANDO™ hardware is available colour matched to a range of powder coat colours.

Standard Colours

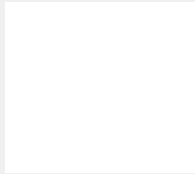

Pearl White
GLOSS 1004



APO Grey
SATIN 1001



Dune®
MATT 1010



Citi
PEARL MATT 4026

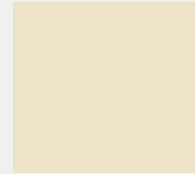

Magnolia
GLOSS 2012

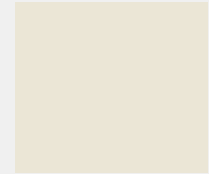

Rivergum Beige
GLOSS 2018

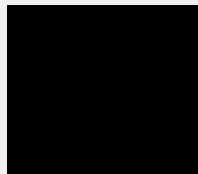

Custom Black
MATT 1002

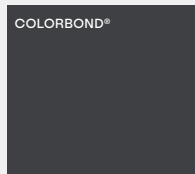

Monument®
MATT 1011



Woodland Grey®
MATT 1008

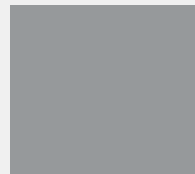

Silver Medallist
PEARL SATIN 4028

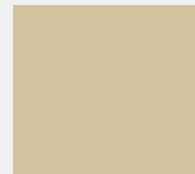

Stone Beige
MATT 2031

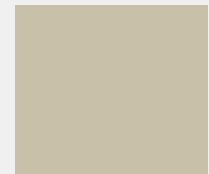

Pottery
SATIN 2017

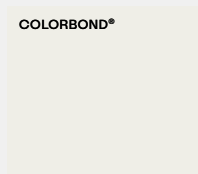

Surfmist®
MATT 1013

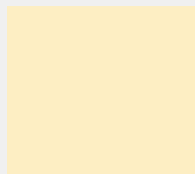

Primrose
GLOSS 1005

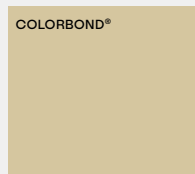

Paperbark®
MATT 1012

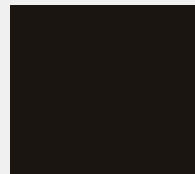

Charcoal Metallic
GLOSS 4025

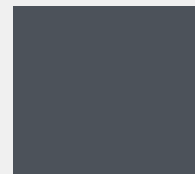

Berry Grey
SATIN 2032



Dark Grey
MATT 2005

NOTE The finishes displayed on this page are a guide only and may not be actual representations of the actual finish. For powder coat samples, you can order samples from the colour page on the Vantage or Elevate website. Your local Vantage and Elevate supplier may also have samples by request. For custom powder coat requests, see your local fabricator for more information.

Care & Maintenance

Powder Coated Hardware

Like any other painted surface, powder coated hardware performs at its best when it is properly cared for. Keeping the surface free from pollutants and environmental contaminants will give you the maximum benefit and long-lasting performance from your powder coated surface. This is particularly important in harsh locations such as beachfronts, severe marine environments or areas of high industrial pollution.

Recommended cleaning

Gentle cleaning with a soft brush and mild detergent, followed by a fresh water rinse, will maintain the long-term performance of your powder coated products. In rural or normal urban environments, cleaning should occur every six (6) months.

In particularly harsh locations such as beachfronts, severe marine environments or areas of high industrial pollution, cleaning should occur every three (3) months.

Do not use strong solvents, abrasive cleaning products or any product recommended for thinning paints.

If you need to remove splashed paint, sealants or mastics from your powder coated products, use white spirits, carry out cleaning in shade and during cooler temperatures using a soft cloth and gentle wiping only.

We recommend that prior to using any cleaning agent on your hardware, you test a small non-visible area of your powder coated product to ensure that no visual colour change or damage will occur.

Stainless Steel Hardware

Stainless steels are very resistant to rust, however this does not mean that they are immune to it. Stainless steel will rust, and must be kept clean and free from contaminants. Frequent cleaning is a requirement. Stainless steel will develop discolouration, rust spots, and corrosion brought about by environmental and installation conditions.

Environments with exposure to the following substances should be avoided:

- Chlorine based (bleach) products and cleaners.
- Hydrochloric acid (commonly used for tile and concrete cleaning).
- Cement dust.
- Soap concentrates.
- Water with high iron content (i.e. bore water).

Removing tea staining & marks

One of the advantages of stainless steel hardware is that any rust spots can be easily removed and generally the product will return to its "new" state with appropriate cleaning. Most discolouration can be removed with a mildly abrasive cleaner (Ajax, Jif, Brasso etc.). Heavier corrosion and rust can be removed using a Scotch-Brite™ pad or stainless steel scourer. Do not use steel wool, as this will leave residues of steel which will rust. After cleaning, the product should be rinsed free of all cleaning product residue with fresh water.

With proper maintenance, stainless steel will maintain its lustre and appearance indefinitely.

Hardware Warranty

All hardware products supplied by AWS are covered by supplier warranties. The specific details of product warranty vary between ranges. In general, the following warranty considerations apply:

Hardware items are warranted to be free from defects in material and workmanship for a period of six (6) years from the date of purchase.

Various exclusions may apply, including but not limited to:

- Misuse, abuse, accidental or intentional damage, improper or negligent adjustment or operation by the purchaser
- Improper or negligent maintenance or installation
- Inaccurate or incorrect site or operational specifications
- Repair or modification
- Use contrary to the manufacturer's instructions
- Use of replacement parts other than authorised parts
- 'Tea staining' on stainless steel
- Corrosion related damage
- Tarnish or wear on soft finishes

Please speak with your fabricator to request a copy of the appropriate product warranty for the hardware items you choose.





Hardware solutions for your windows & doors.

For more information and to find your local Vantage® suppliers:

vantagewindows.com.au

For design inspiration & tips, follow us:

 **[vantagewindowsaus](https://www.instagram.com/vantagewindowsaus)**

 **[vantageaustralia](https://www.facebook.com/vantageaustralia)**



ABN 48 067 950 903

HEAD OFFICE

76-78 Jedda Road,
Prestons NSW 2170

PO BOX 311
Liverpool NSW 1871

HAVE QUESTIONS?

Call us at 1300 026 189 or email marketing@awsaustralia.com.au



Design Matters
Build, connect and inspire
practising design

ARCHITEAM