

The Lighting Bible®

FIFTEEN

 DELTALIGHT®

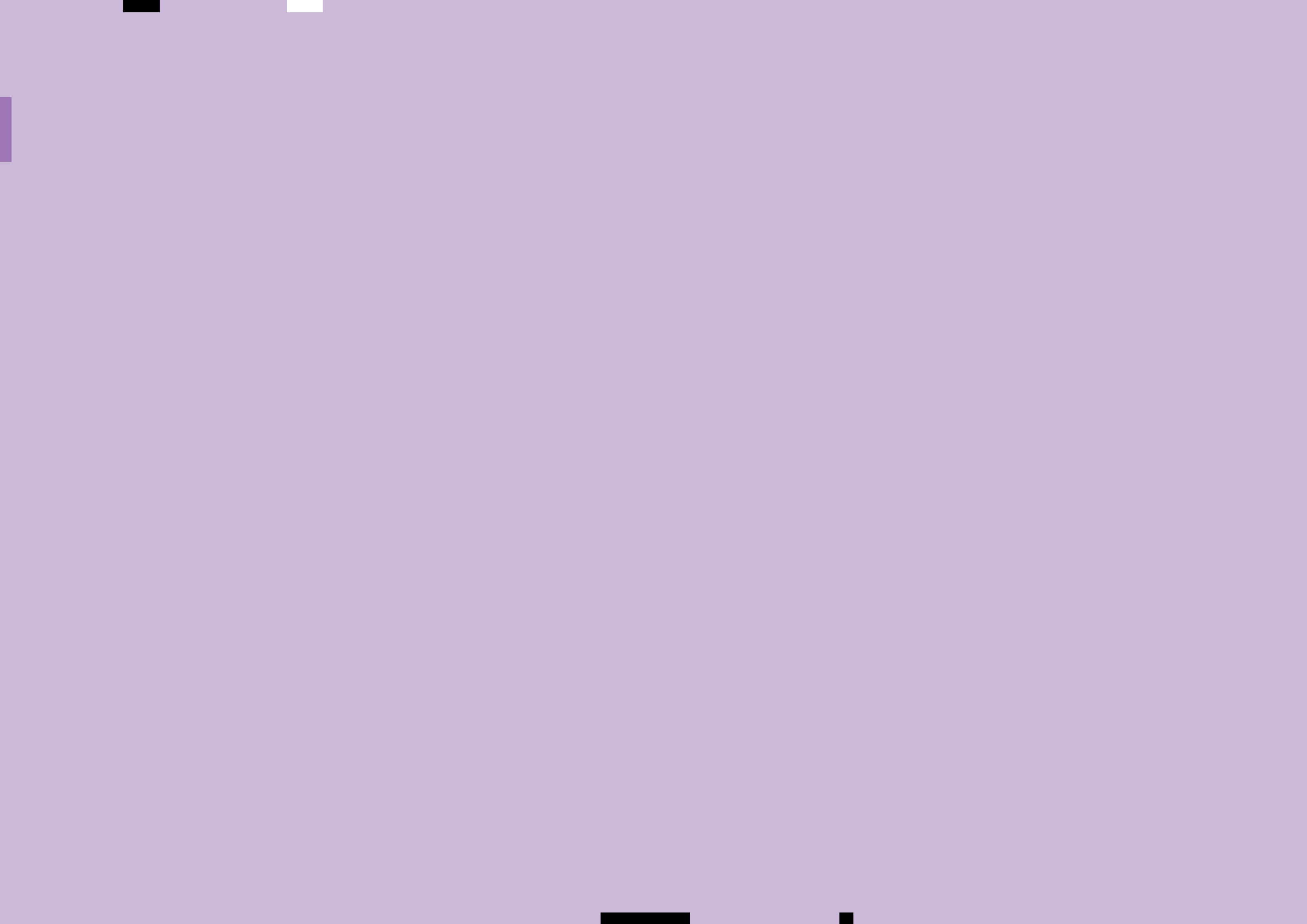

Welcome to our world.

Let's journey into the world of Delta Light with the Lighting Bible 15 Lookbook. Get inspired by new product families, innovative integrations and technical advancements.

This lookbook is a testament to our craft, where light and creativity collide. It will give you a deeper understanding of our architectural lighting solutions, as well as access to summarized technical information.

Nime.

BY DELTA LIGHT & DEAN SKIRA

Invisible. Yet tangible.

The black hole reflects no light, but the light of Nime finds its way out.

The tangible part disappears inside its heart, and the intangible part illuminates the object.
An hole of mere 10mm, a whole lot of options.



FAMILY OVERVIEW.

Choose your colour



Black / White

Choose your power

3,9W up to 10,7W - 385 up to 814lm

Choose your colour temperature

2700K / 3000K

Choose your optics

35° / 52°

Focus 20° to 50°

Choose your type

With or without trim

Fix or adjustable

Extra's

Aperture 10mm

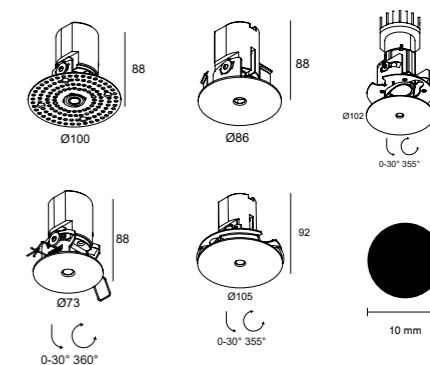





Deep Ringo



New colours



Brushed Grey / Brushed Copper / Brushed Gold /
Brushed Old Bronze / Brushed Anthracite /
Piano Black

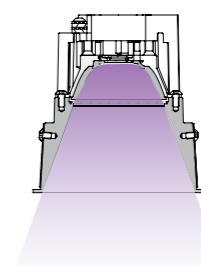

Light is important, influencing the passer-by in many ways. It impacts the inner mood, the physical health, the mental state of mind. We care for that, we study this impact and we implement our findings into our luminaires. Soft Dim technology to set the mood, state-of-the-art LEDs that help to focus during the day and relax in the evening or careful positioning of the LEDs within the design of our luminaires to enhance the human visual comfort are some examples that show we care.

Visual comfort

Size matters*

Mini Deep Ringgo.

Although we like to stand out, we like to fit in just as much.

Fit in the concept, fit in the lighting design, fit in the architecture. Our miniature lighting fixtures do just that. They are designed to perform and designed to fit in. Unnoted to the eye and seamlessly integrated into any ceiling.

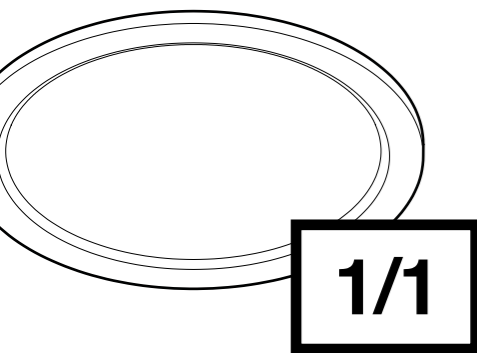

FAMILY OVERVIEW.

Choose your colour



Black / White

Choose your finish

Fix

Choose your power

5,8W up to 8,6W - 734 up to 1018lm

Choose your colour temperature

2700K / 3000K

Choose your optics

37°

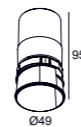

* this quote is open to interpretation



Entero

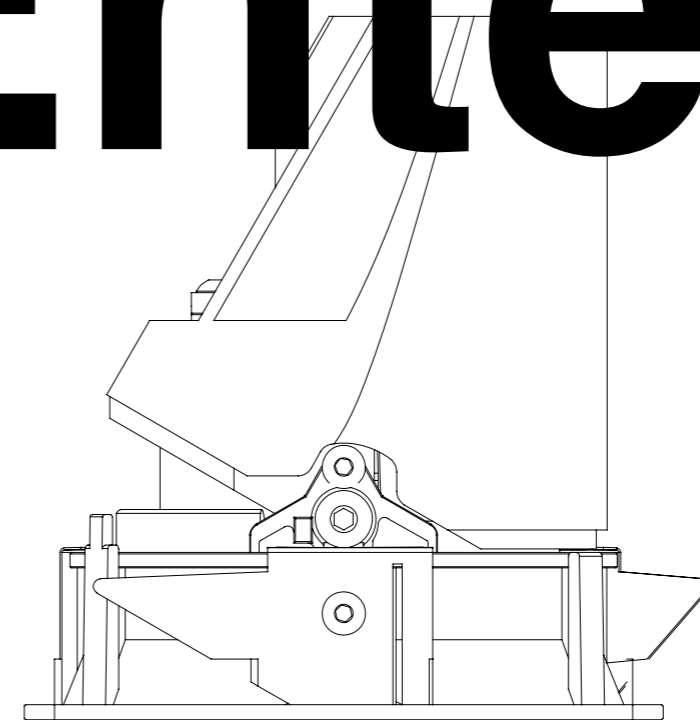

Entero is derived from the Spanish language and means “complete”. It is the most complete product family, created to excel in any environment. A full range of recessed downlights providing a solution for diverse lighting dilemmas. Any project type: retail, residential, public, hospitality, art... Any need. Any size. Anywhere.

FAMILY OVERVIEW.

Choose your colour



Choose your installation

Trim / Trimless
Adjustable

Choose your shape

Round / Square
Small / Medium / Large

Choose your Power

Small 5,7W up to 12,4W - 520 up to 1470lm
Medium 8,2W up to 24,6W - 680 up to 2900lm
Large 10,7W up to 36W - 810 up to 4600lm

Choose your optics

Small 10° / 20° / 45° / Wallwash

Choose your LED colour

2700K / 3000K / Soft Dim / Tunable White

Choose your accessory

Honeycomb / Glass SBL / Linear Spread Lens
Softening Lens / Spread Lens

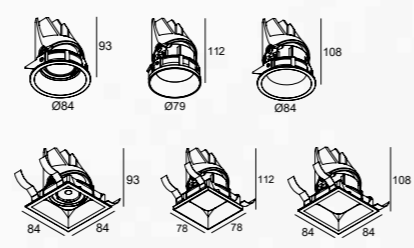



One for all



Obin.

Obin. Based on the patented ERS (Ex-Centriq Rotation System) and equipped with flat lenses, Obin fuses ultimate flexibility with supreme user comfort in a minimalistic surface mounted lighting fixture.

By adjusting the rounded backside - using the ERS system - Obin is 360° rotatable and 45° tiltable without the need of an additional hinge. On the frontside, the sleek lenses create a sense of depth without the need of real physical space. Combining both results in free space on the inside to house a DALI power supply, perfect for an easy individual controllable surface mounted lighting scheme.



FAMILY OVERVIEW.

Choose your colour



Black / Brushed Grey / Brushed Gold /
Brushed Old Bronze / Brushed Anthracite / White

Power

11,6W - 1524lm

Colour temperature

3000K

Choose your optics

24° / 36°

Choose your control

Mains Dim / DALI Dim

Choose your installation

Surface mounted - Single / Double
As module on our magnetic profiles

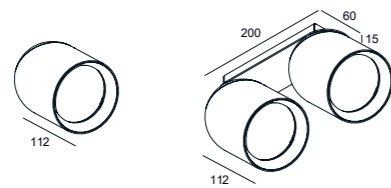

E.R.S.
EX-CENTRIC
ROTATION
SYSTEM



**Cute outside,
Functional inside**



OCTAV 27.

Choose your colour



Black / Flemish Bronze-Black / Flemish Gold-Black /
Gold Coloured-Black / White

Choose your installation

Semi-recessed / As module on magnetic profiles

Power

5,8W - 790lm

Choose your LED colour

2700K / 3000K

Optics

30°

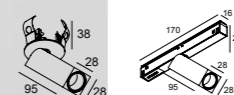

OCTAV 39.

Choose your colour



Black / Flemish Bronze-Black / Flemish Gold-Black /
Gold Coloured-Black / White

Choose your installation

Semi-recessed / Surface mounted single or double /
As module on magnetic profiles

Choose your power

5,8W up to 8,6W - 790 up to 1090lm

Choose your LED colour

2700K / 3000K

Optics

20° / 40°

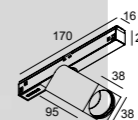

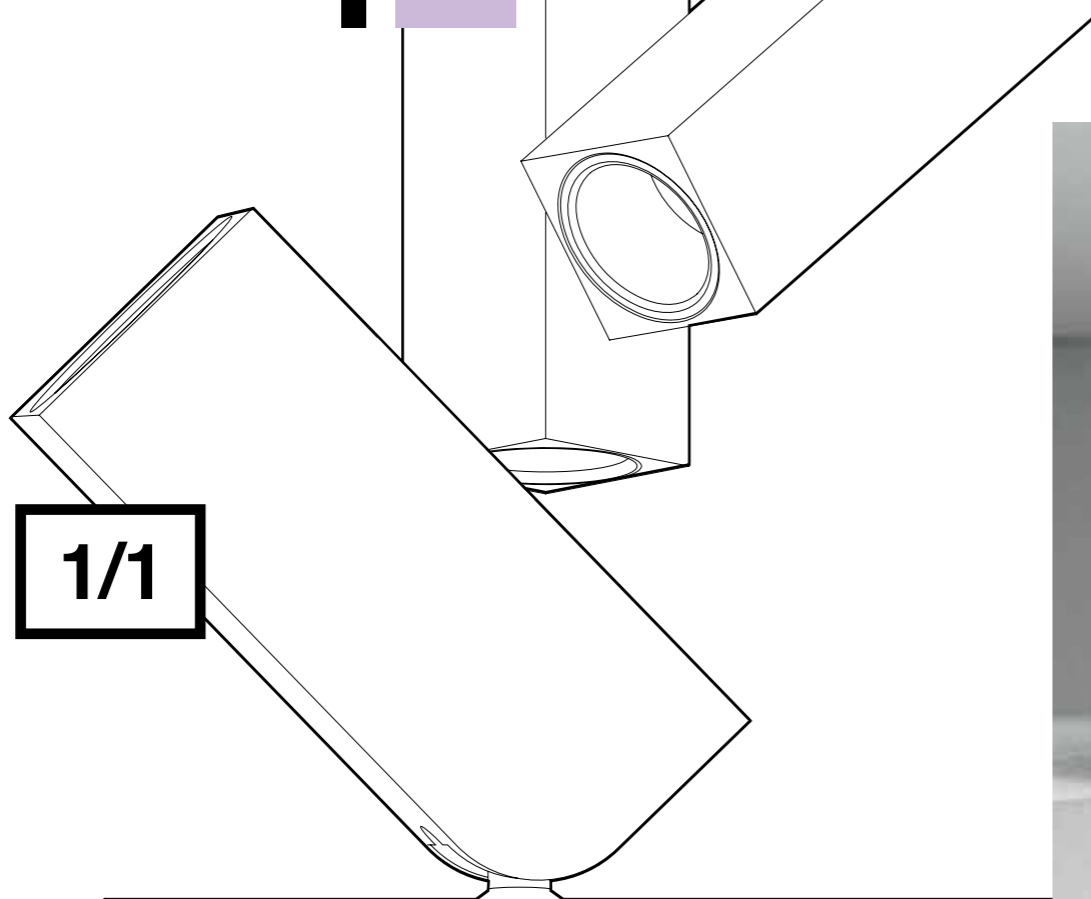

Octav

However you look at it, Octav draws the attention. Its design catches the eye, and after a first glimpse for sure you will be intrigued to look at it again. Depending on the inclination angle of the adjustable spotlight, other design elements stand out.



**You will be
intrigued
to look at it
again**



Boxy.

We love a challenge and we don't step away from them. Reinventing our evergreens is one of those. Take Boxy, once a single surface mounted cube for halogen lamps, now an elaborate family of cylindrical and cubic shaped fixtures that even fit on our magnetic profile range. We strive to be one step ahead and build on what you love.



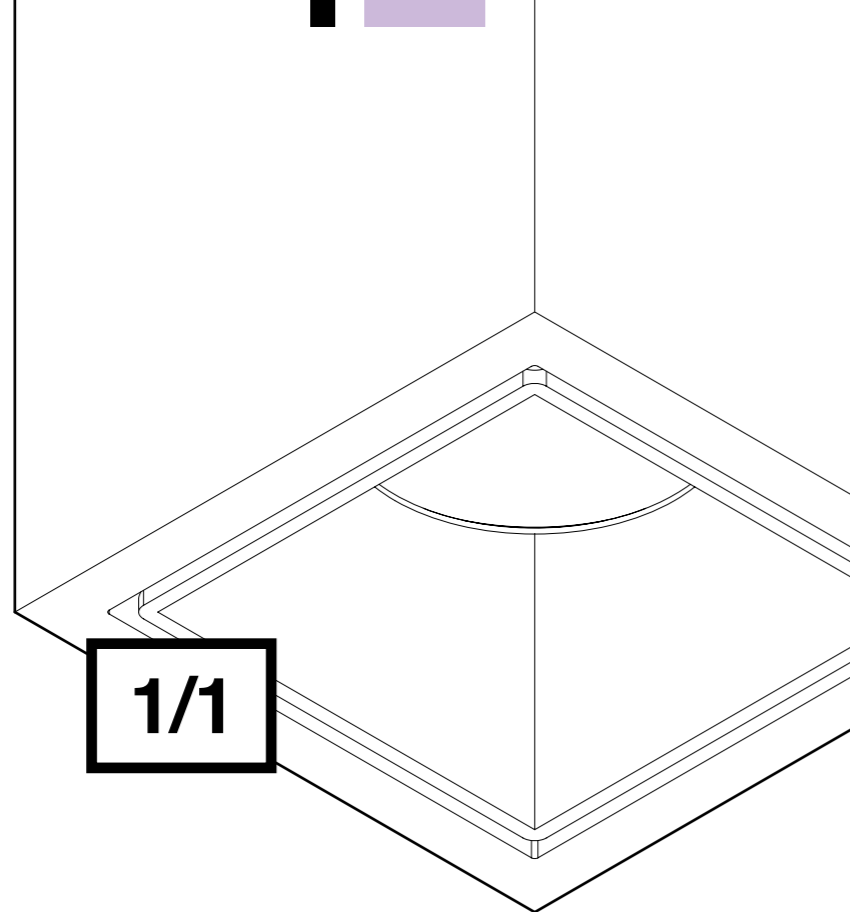

we keep renewing
our Evergreens
because we love
them as much as
you do.

FAMILY OVERVIEW.

Choose your colour



White-Black / Black-Gold Matt / Black-Flemish Gold /
Black-Flemish Bronze

Installation

As module on our magnetic profiles

Choose your shape

Round / Square / Square asymmetric

Power

8,6W - 1090lm

Choose your LED colour

2700K / 3000K / Soft Dim / Tunable White

Choose your control

MDL Dim / DALI Dim

Choose your accessory

Honeycomb / Softening lens / Glass SBL

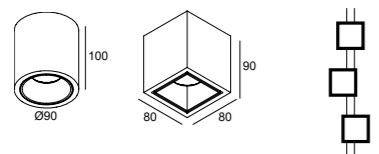



Transform your ceiling with ease. With the Spy 39 Plug, you can bring your creative vision to life. Simply install the kit into your ceiling, plug in the Spy 39 Plug and voila! Create an ambiance that suits your style and say goodbye to complex installations and hello to effortless lighting with a sleek finish.

Spy 39 Plug

Plug & Play

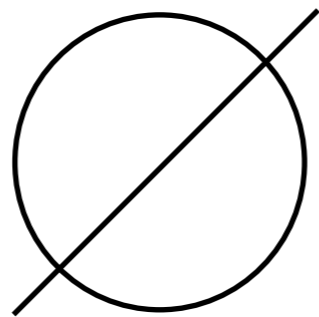

39mm

FAMILY OVERVIEW.

Choose your colour



Black / Flemish Bronze / Flemish Gold,
Gold Coloured / White / Brushed Grey /
Brushed Copper / Brushed gold / Brushed
old Bronze / Brushed Anthraoite /
Piano Black

Choose your power

8,6W - 1089lm

Choose your colour temperature

2700K / 3000K

Choose your optics

20° or 40°





Panache

Put some dash into it! We've added some colours for you to explore and to experiment with. 5 new brushed colours ranging from grey to copper, accompanied with the shiny Piano Black finish. Allowing you to play with finishes, be it for a more classy look and feel or to create a modern twist within contemporary architecture.

Choose your colour



Brushed Grey / Brushed Copper /
Brushed gold / Brushed old Bronze /
Brushed Anthraoite / Piano Black

**Flamboyant
confidence of style**



▲AIR

Air is a powerful combination of architectural lighting and ventilation. Thanks to the intelligent integration of ventilation into lighting fixtures, ventilation openings in the ceiling are no longer necessary. This offers a lot of new possibilities for architects and interior architects



**Less does
more**



!

~~Soft ceiling~~



**Make the
~~visible~~
invisible.**



The Soft Ceiling© concept offers numerous possibilities for the integration of architectural lighting. It enables architects and designers to work with a variety of lighting applications, light beams and power levels, with unobtrusive and non-glare luminaires for a ceiling with a clear sight-line. The large number of options with Trimless Suspension and Connection sets makes it possible to work with a Soft Ceiling© fixture throughout the project and meet the different needs of each room, without ruining the look of the ceiling.



Shape your wall into a piece of art. The layers of light generated by Band-Oh! provide a sense of depth onto the surface its being installed on. The light not only hits the wall for a V-shaped down-up light effect, it also creates a play of light on the fixture itself.



FAMILY OVERVIEW.

Choose your colour



Piano Black-Black / Brushed Old Bronze

Power

2 x 8W - 630lm

Choose your colour temperature

2700K / 3000K

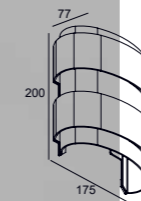



Band-oh!

**Layers of
light**





FAMILY OVERVIEW.

Choose your colour



Black / Gold Coloured

Choose your length & power

Length 1485 / 1985 / 2985 mm
20W up to 41W - 1568 up to 3278lm

Choose your colour temperature

2700K / 3000K

Choose your light effect

General light / Task light

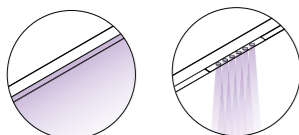

Wall - Ceiling

Let your creative vision soar as you transform your wall and ceiling into a work of art with the Mikaline wall and ceiling models. These models can effortlessly stretch from one end of the ceiling to another, span across walls, or even transition from wall to ceiling, creating a seamless fusion of multiple planes within the same space. The possibilities are endless with Mikaline and its connection sets.

Pendant

The Mikaline pendant models have the flexibility to be oriented horizontally or vertically, giving you the freedom to create unique hanging lighting solutions. The pendant models can also be attached to the wall at one end, forming a seamless connection between planes. Play with lines of light and let your imagination take flight with Mikaline.

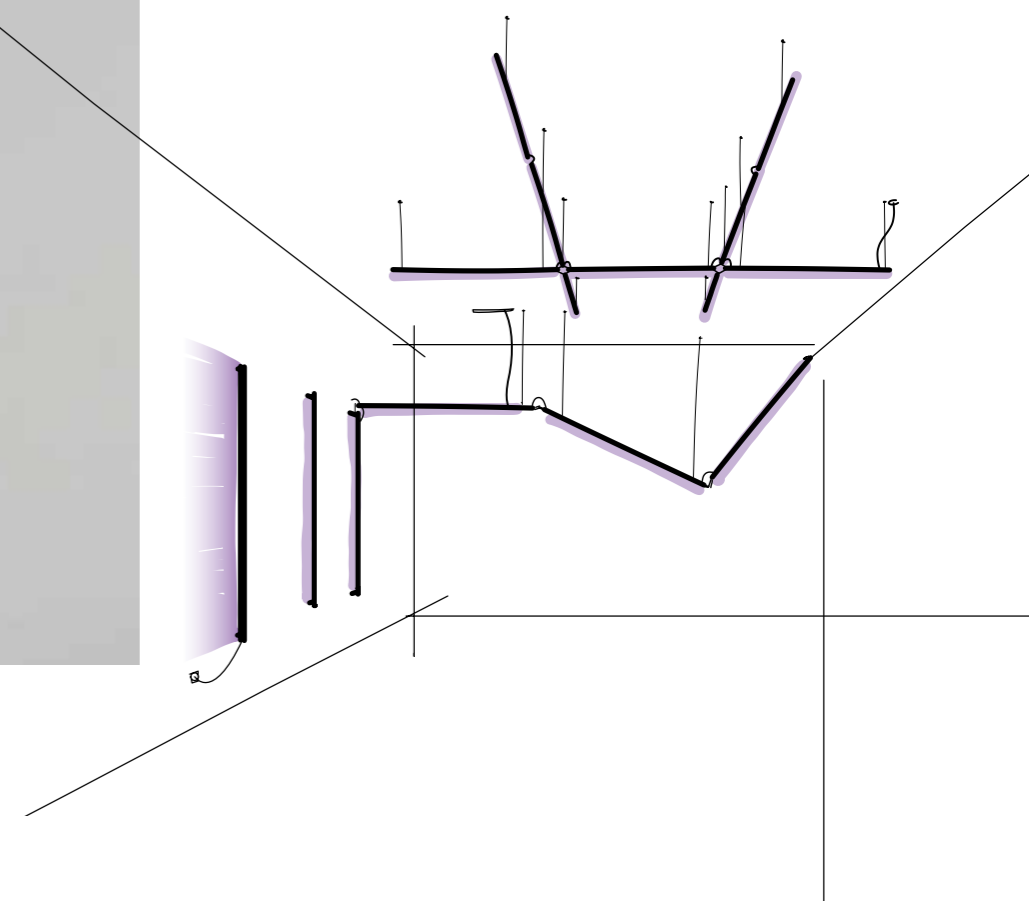

As a set of tools, Mikaline let's you paint lines of light without limits, with the room as a blank canvas and the wall, floor or ceiling as a starting point, you can go any direction you want. Create frameworks that light up the room completely, opt for a cosy setting with only indirect light towards the wall or go for a pure linear pattern with dedicated task lighting, possibilities are endless and customizable to individual preferences.

Mikaline

Like brush
strokes on a
blank canvas



The base of this family is a combination of Delta Light's Melanopic Light Technology (MLT) with high efficient louvre optics.

1/1

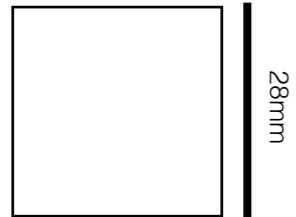

INFORM SQ



INFORM 40

INFORM 40

Choose your colour



Black-Black / Black-White

Installation

Surface mounted, Suspended

Choose your length & power

Length: 1600 / 1800 / 3200 / 3600 mm
16,8W up to 26,4W / 2643 up to 4051lm

Extra's

PDS : Presence & Daylight Sensor

LED colour

MLT - Melanopic Light Technology
3000K / 4000K
Tunable White

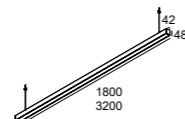



The Inform family is an extensive range of linear and curved lighting solutions, designed to be used in applications that include task areas, like landscape offices, meeting rooms, reception desks, home office, ... Areas which need technical architectural lighting at its best: eye for design, eye for the user and eye for performance.

Inform

FAMILY OVERVIEW.

Choose your colour



Black-Gold Coloured / White-Gold Coloured

Installation

Single pendant
As module on our magnetic profiles

Choose your shade

4 designs
As a single shade or combined to your preference

Power

8,6W - 1090lm

Choose your LED colour

2700K / 3000K / Soft Dim

Optics

40°

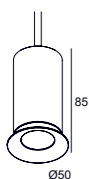

The Cuppa family has been designed as a welcome add-on for our magnetic profile range, extending the possibilities within this collection with decorative pendants. As a basis, Cuppa offers 4 attractive shades to be used as an ornament on a suspended LED module. But in total the possibilities with Cuppa are endless, as multiple shades can be added onto 1 single module, giving the user complete flexibility of designing the product he or she envisioned.

Elegance visualized

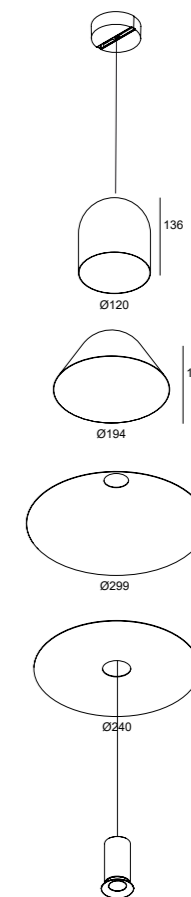



Сирра

Slim, circular eye catchers

FAMILY OVERVIEW.

Choose your colour



White / Black / Gold Coloured / Flemish Bronze / Flemish Gold

Choose your light effect

From the inside / On the outside / Downwards

Choose your size and power

Diam. 700 / 900 / 1200 / 1700mm

30,3W up to 73,5W - 3510 up to 8540lm

LED colour

3000K

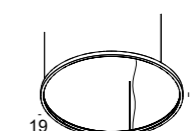

Superloop Slim further explores the boundaries of circular general light, as it offers three different ways of diffusing light around a room. Within its small size, Superloop Slim hides away a specially designed current controlled LEDflex, covered by a sandblasted diffuser to evenly spread the light. The diffuser is either installed on the inside of the circle, on the outside or facing downwards, providing various looks and displaying a different take on a circle of light.



reddot design award





Superloop
Slim

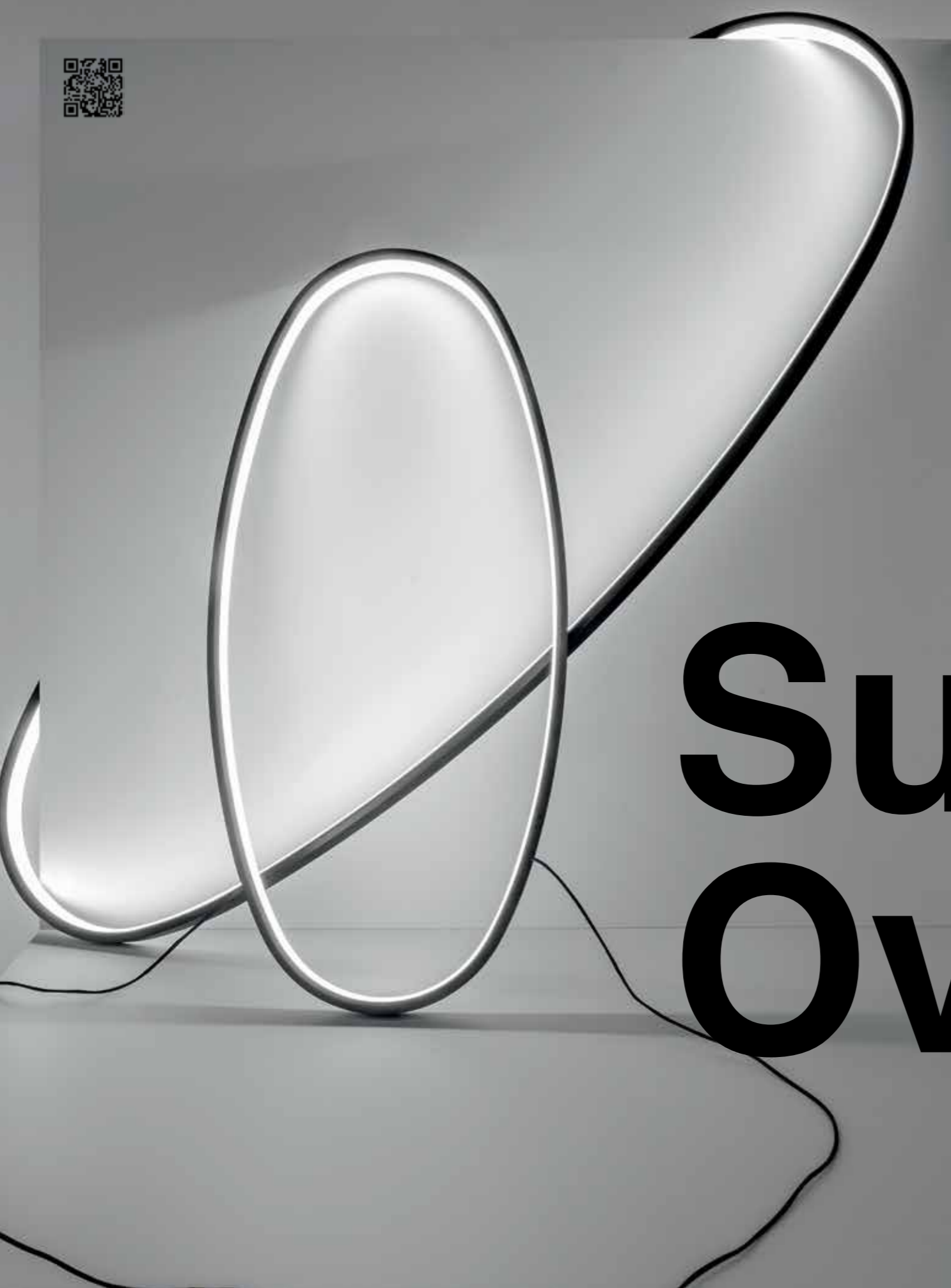

The Superloop SBL has the ability to diffuse light all around. It represents a universal symbol with extensive options, rolled out of 1 aluminium profile and seamlessly welded together into an oval shape. It is both functional and a real eye-catcher. The specially designed current controlled LEDflex inside Superloop SBL allows it to be dimmed in various ways. Diameters up to 1700mm and finishes in different colours let you create the setting you want.

Superloop Oval



FAMILY OVERVIEW.

Choose your colour



White / Black / Flemish Bronze / Flemish Gold

Choose your size and power

Small
38.7W - 4570lm

Medium
51.9W - 6027lm

Led Colour
3000K

**Diffuse light
all around**



**From offcuts to
High Profile**

High Profile

MVRDV

The High Profile series is a range of luminaires inspired by leftover aluminium profiles. The design takes a critical look at the manufacturing process, finding both opportunity and beauty in residual elements that would normally be cast aside.



dezeen ²⁰²²
awards
Lighting design of the year 2022





UNStudio and Delta Light have joined forces to endeavour to improve the wellbeing of people in our rapidly changing work environments, where human health and the war on talent have become a primary focus for employers. Together we are developing Soliscape, an extremely versatile and flexible system, specifically designed to create user-centric environments.

Soliscape





**A soft glow
of light during
golden hour,
at the end of
a sky-blue
summers day**



reddot design award

Built in first instance as a family of exterior products,
Oono is a family of dualities.
It combines elegant looks with a warm diffused light effect.
It couples the sturdy look of metal with the pureness of glass.
It unifies exterior and interior, as the range offers IP-rated solutions for outdoor with straightforward surface mounted and pendant luminaires for indoors.
It unites a play of straight lines with perfect circular shapes.
It merges black and white, by adding a touch of gold.
It brings together the shimmer of dusk with the fresh start of dawn.



FAMILY OVERVIEW.

Choose your colour



Alu grey Marbeled / Gold Marbeled / Black / White

Choose your size & installation

Ceiling mounted - Medium
Suspended - Large
Wall Mounted - Small / Medium / Large
Table version - Small

Choose your power

Wall mounted
8,6 up to 17,2W - 1090 up to 2100lm

Ceiling mounted / Suspended
Retrofit

Table
6W - 623lm

Choose your LED colour

2700K / 3000K

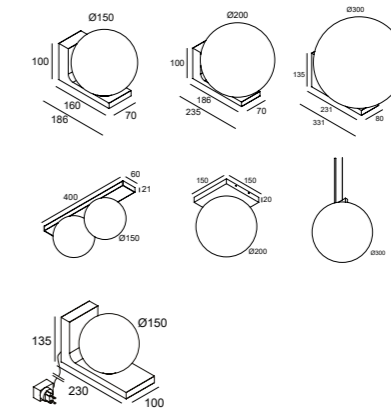

Oono



Make it your own. Our SLM26 F builds on the endless flexibility of our magnetic profiles, which allow a simple toolfree (re)positioning of the lights onto your ceiling. Now also available as stand-alone solution, you can easily personalize the room to your preferences. Opt for simple accent lighting or combine with indirect light for the more cosy settings, your choice!

SLMF

FAMILY OVERVIEW.

Colour



Black

Choose your colour temperature

2700K / 3000K

Choose your version

Shiftline M26 Low

Shiftline M26 High - with or without backlight

Choose your control

MDL modulator dimming

WD wireless dimming

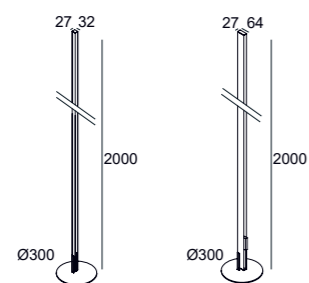

**A personalized
floor lamp**

1 + 1 = 3

The combination of ultimate flexibility with the fine line of light running next to it adds to possible applications for the Shiftline M26 H, as accent lights can be combined with general light without limitations. Boost your creativity by plugging in any light module you want in the magnetic profile without interrupting the continuous light of Tagline that runs along. A perfect example of 1 + 1 = 3.

Go for **ALL ON** and light up all light modules at the same time, including the linear Tagline
Go for **ONLY ACCENT** to switch on the magnetic modules and create a cosy setting by highlighting the accents you prefer
Go for **ONLY GENERAL** and use the fine line of light for a soft general light effect



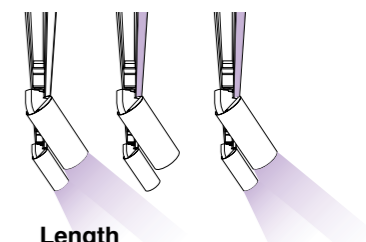

Length
Available in 2 / 3 or 4 meters

SLM26H

+SBL



reddot winner 2023
best of the best

The range of Femtoline profiles is very extensive, with each family member having its own specific design and application area. Small or wider profile design, down or down-up lighting, wall, ceiling or floor mounted, flush or tilted plexi, ... the Femtoline family offers a solution to any lighting problem. As diverse applications ask for diverse optics, Femtoline 35F HE comes in 3 different optical finishes: sandblasted for general lighting, prismatic for task lighting and our LGC (Low Glare Control) extrusion that avoids direct interaction between LED and the human eye when looking at it from aside.

Femtoline



Diverse applications ask for diverse optics



PR - prismatic

SBL - sandblasted

LGC - linear glare control

**Make your
own path**

Narrow and wide streets draw black lines through space and literally form a 'lighting path' that dialogues with the architecture of the surroundings. The Splitline profiles can be interpreted in very varied ways, depending on what the space needs, both functionally and in terms of design. Flexible led modules for accent lighting, LED lines for general light, or high-power led modules for an extra-powerful solution.

Splitline

FAMILY OVERVIEW.

Choose your colour



Black

Choose your setting

Straight lines, T sections, X sections, with 90° corners or bended curves

Choose your light module

Accent

Spy / Vizir / Hedra / Punk / Tweeter / Pion / Odron / Bowie / Haloscan / Obin

Decorative

Tweeter BL / Gibbo / Spy / Cuppa

General

Inform / LED Line / Dot.Com / Multinova / Jum-Oh!

Wallwash

Dot.Com / Spy

Choose your control

MDL Dim / Wireless Dim / DALI Dim

Choose your EXTRA'S

Sensors

Presence - Daylight



reddot winner 2023



product
design
award

2020

Magnetic corners

Think of a lighting solution that is not only flexible but also creative. Imagine having the ability to install and re-install luminaires into the profile, while also using the profile itself to draw unique sets of black lines into the ceiling. With multiple curves, corners, T- and X-sections available, the possibilities are endless. You have the freedom to create a structure that matches your vision. And the best part? You can combine corners to make your creation even more unique.





With the elaborate D-Liner family, Delta Light offers a range of linear and spotlight solutions to create any desired light setting for SAPP ceilings by Interlu or HeartFelt ceilings by Hunter-Douglas. Both ceiling systems build on modularity and allow for a linear lighting solution in between or in line with the panels.

For climate and acoustic ceilings

D-LINER INFORM.

Choose your colour



Black / Black-Gold Matt / White-Black / White

Choose your ceiling type

Climate ceiling (SAPP / 30BD)
Acoustic ceiling (Hunter Douglas)

Choose your installation

In line with slats
Between slats

Choose your size & power

840 / 1116 / 1392mm
15,3W up to 25,5W - 2630 up to 4390lm

Choose your LED colour

3000K / 4000K

Optics

67°

Extra's

Presence & Daylight sensor

D-LINER SBL.

Choose your colour



Black / White

Choose your ceiling type

Climate ceiling (SAPP / 30BD)
Acoustic ceiling (Hunter Douglas)

Choose your installation

In line with slats

Choose your size & power

830 / 1114 / 1390mm
27,3W up to 45,5W - 3550 up to 5915lm

Choose your LED colour

2700K / 3000K

Choose your control

Remote driver / DALI Dim



D-LINER SHIFTLINE 19

Choose your colour



Black

Choose your ceiling type

Climate ceiling (SAPP / 30BD)

Installation

Between slats

Choose your light modules

Uho / Spy 27 / Spy 39

Choose your control

MDL Dim (Smart 48) / DALI Dim

Optics

67°



D-Liner

Logic



Our Logic extensions are the perfect example of our continuous quest to innovate. A range that breathes quality, shows our idea of family thinking, makes use of clever design and most of all adds to our Delta Light outdoor range. With the Logic 190 R OK as masterpiece - fully adjustable on-site without the need of opening the luminaire.



Smart, clever, Logic!



FAMILY OVERVIEW.

Colour

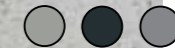

Anodized aluminium / Black / Inox

Choose your optics

LED Caset technology - Logic 190
11,9 up to 12,6W - 1406 up to 1530lm
14° / 26° / 47°

Reflector - Logic 190R

13W - 1855lm
18° / 32° / 45°

Accessory

Honeycomb for improved visual comfort

Choose your version

- LED Caset technology: Fix / Adjustable
- Reflector

IK10

IP67

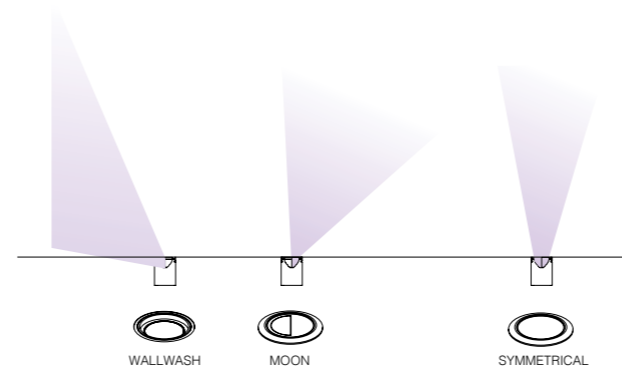

Brings any architecture to life

FAMILY OVERVIEW.

Colour



Dark Grey / Inox

Power

14,4 up to 28,8W - 1648 up to 3296lm

Choose your colour temperature

2700K / 3000K / 4000K

Choose your control

Non dim / DALI

Choose your installation

Single or in Line

Choose your optics

15° / 25° / 40°

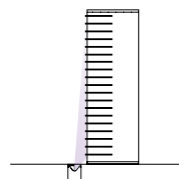
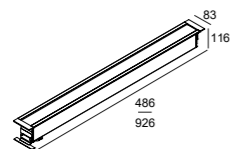

Logic Linear

Based on the same principles as Logic 190 R, Logic Linear offers additional options in linear uplighting. As an individual projector or installed in a continuous line, these fittings are perfect to install around facades or other architectural elements. With its wallgrazing optics, Logic Linear easily lights up structured vertical surfaces to enhance the sense of depth of the structure and make them more lively.

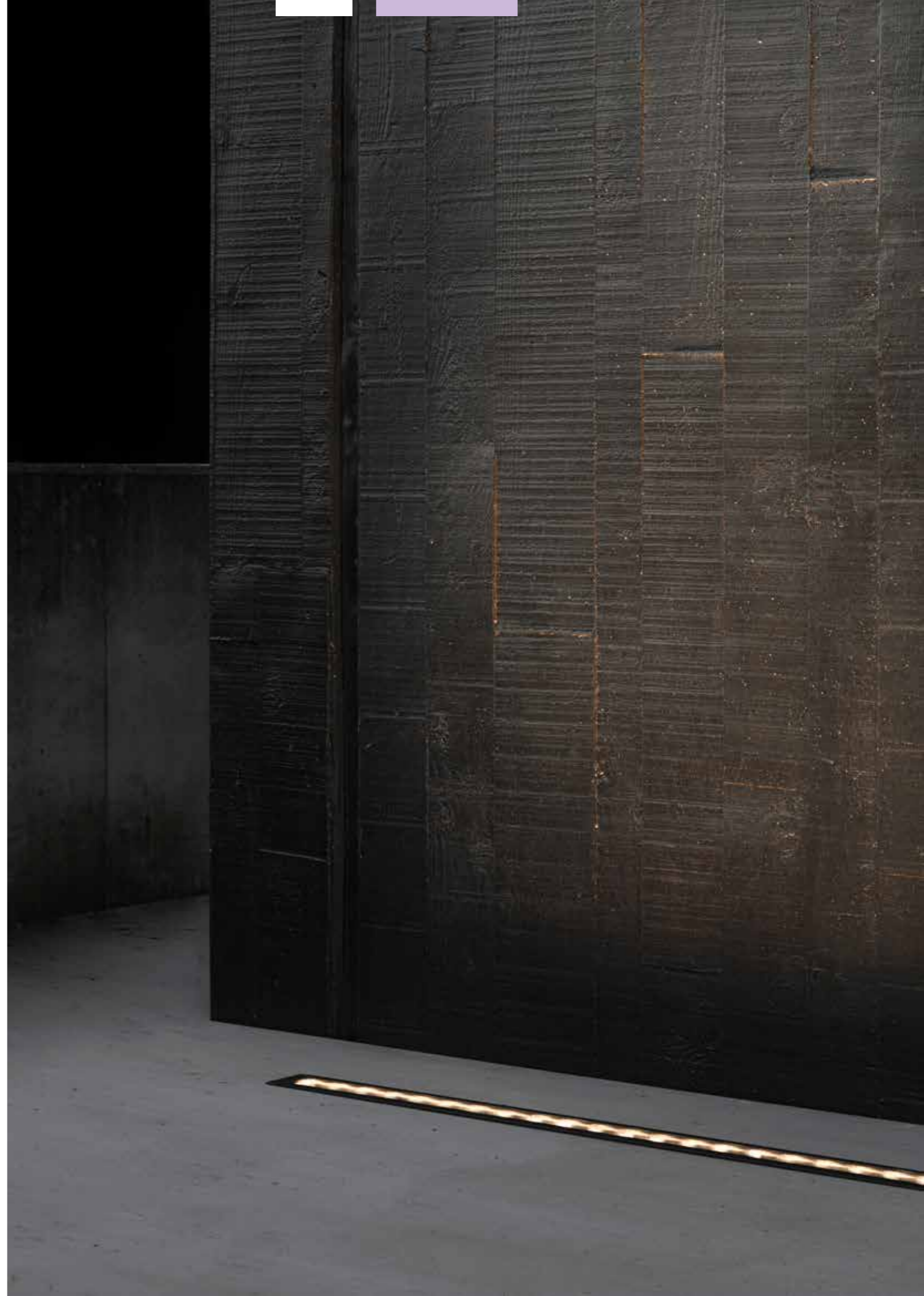



As a range of full IP65 wall fixtures, Nocta is the example that form and function can be merged into one. Build around 4 types of optics, Nocta is available in a cylindrical or cubical design, both with a down or down-up light emission. The cubical version also has a wider brother with double light beams, a way to add a more decorative touch onto the wall.

FAMILY OVERVIEW.

Colour



Dark Grey

Power

1 or 2 x 4W up to 2 x 5,7W
1 or 2 x 464lm up to 1 or 2 x 734lm

Choose your colour temperature

2700K / 3000K

Choose your shape

Round / Square / Rectangular

Choose your optics

Spot / Wide Flood / Very Wide Flood / 2 x Very Wide Flood

Choose your light effect

Down / Down-Up

Choose your control

Non Dim / DALI Dim

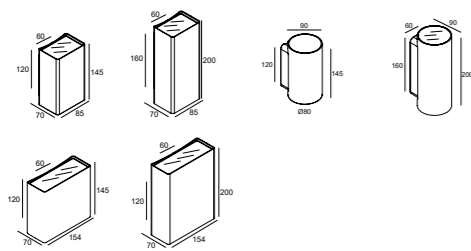

SP
SPOT

WFL
WIDE FLOOD

VWFL
VERY WIDE FLOOD

2VWFL
2 x VERY WIDE FLOOD

Variety in
shapes and
optics

Nocta



FAMILY OVERVIEW.

Choose your colour



Dark Grey / Grey

Choose your power

17,9W up to 23W - 1800 up to 2400lm

Choose your optics

8° / 14° / 26° / 47°

Other effects:

Linear spread

Choose your accessory

Honeycomb

Snoot

Installation

Mounted on a pole / Maximum of 4 Frax

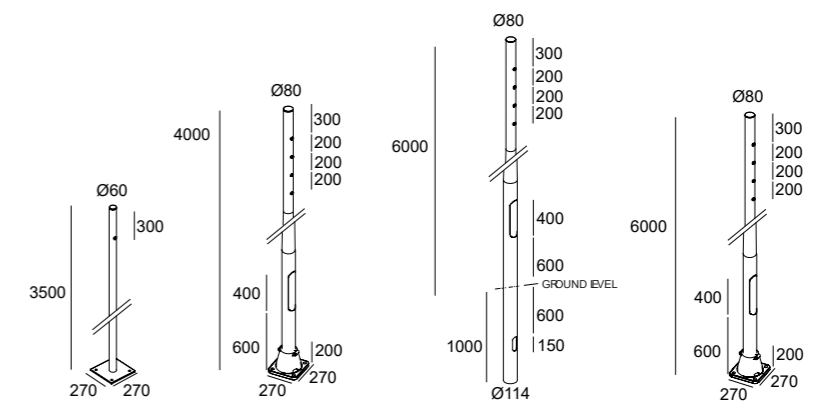



Optical Precision

Light and ambiance not only fit indoors, by combining light and architecture, outdoor settings also remains vibrant at night. With 7 different light effects and multiple installation options, Frax has been designed for every aspect of the urban architecture: any form, any material or any composition.

Frax P





Pine

**Green,
the prime colour
of the world**

Green is fertility
Green is yellow, green is blue
Green is growth
Green is young, green is fresh
Green is calming

Green is life
Green is new,
Pine Green is new

Spix only

