

THE METROLL MATE

A GUIDE FOR ROOFERS



A Met-TECH™ GUIDE

FEBRUARY 2023



Metroll®

BETTER SERVICE • BETTER BUILDING SOLUTIONS

THE METROLL MATE

The Met-TECH Metroll Mate is a general information resource for roofers. It's a handy guide to roofing information and is complemented by the full range of Metroll Met-TECH product and design guides.

This manual is designed to provide general roofing information and guidance for non-cyclonic application.

CONTENTS

Roof Terminology	2
Frequently Used Roofing Terms	3
Steel Colour Range	4
Material Finishes	5
Material Selection & Corrosion	6
Roofing & Walling Product Tables	7
Sheet Coverage by Profile	8
Fastener Selection Guide	9
Fastener Quantity Guide	10
Drainage & Overflow	11
Gutter Overflow	13
Metroll Gutter Profiles	15
Roof Pitch & Quantity Estimator	17
Curving & Bullnosing	19
Thermal Expansion	19
Flashings & Custom Made Flashings	20
General Installation Information	22
Maintenance & Cleaning	23
BlueScope Steel Warranties	23
Vehicle Loading Guide	Back Cover

What is Met-TECH™ ?

Met-TECH™ is Metroll's Technical Resource Centre. It is the one stop shop for all of Metroll's product and technical information. Perfect for builders, contractors and specifiers to source all the information they may require. You can find other Met-TECH items on our website

www.metroll.com.au/resources

ROOF TERMINOLOGY

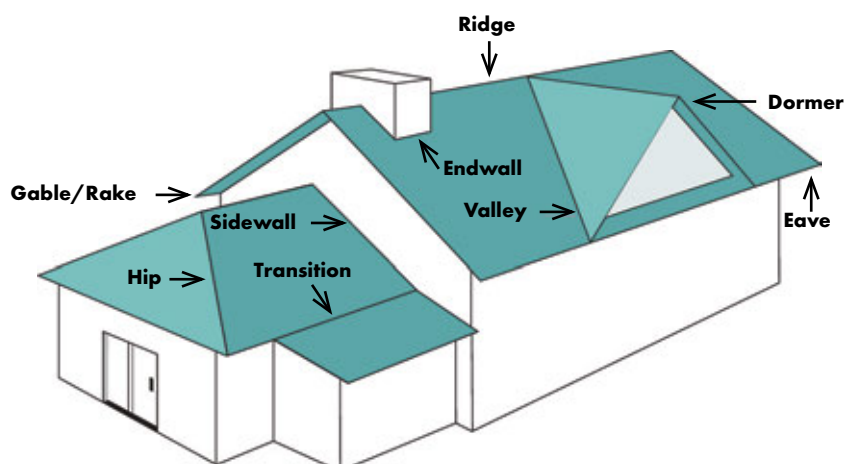

FREQUENTLY USED ROOFING TERMS

AIR VENTING Allowing air to enter or exit a confined space.

APRON Metal flashing used where a roof meets a vertical face, such as walls and chimneys.

BARGE CAP A flashing that is used to fix the gable end of the roof where the sheets start and finish.

BATTEN A long strip of squared timber or rolled metal that roof sheets are screwed onto.

BMT Base Metal Thickness.

BOX GUTTER A gutter that is not on an eave. Typically installed at the base of two opposing roof faces or inside a parapet wall.

CAPPING Metal caps which are installed as a waterproof device where roof sheeting ends.

CEILING BATTS A type of bulk insulation designed to fit in the roof space between joists, rafters or studs. Typically made from glass wool, polyester or wool.

COATING CLASS Refers to the level of corrosion protection. It is directly proportional to the coating mass.

CONCEALED-FIX A type of decking/roofing that is locked into obscured fixing clips which have been fastened to the roof supports, rather than being fixed by visible screws.

COR-STRIP® A removable polyethylene film which protects roof and wall sheeting during storage.

DOWNPIPE A pipe that carries rainwater from guttering to ground level or a drain.

EAVES The external ceiling between the fascia and the outside wall of a building.

EDGE PROTECTION A temporary safety rail system attached to the perimeter of a building during installation to prevent roof falls.

FALL The difference in height between two points in the direction of water flow.

FASCIA A timber board or rolled metal panel fixed along the eave to which a gutter is secured.

FASTENER A fixing object designed to bolt, screw, fasten or attach items.

FLASHING The material placed around any roof projection in order to cover and waterproof the join.

GABLE A traditional roof style where two sloping roof planes meet at a ridge line.

GAUGE The thickness or diameter of a small or thin object; such as the thickness of sheet metal or the diameter of a screw.

GUTTER A shallow trough fixed under the roof edge designed to carry water.

HIP ROOF A style of roof with four roof planes which come together at a peak and four separate hip edges.

INSULATION BLANKET A glass-wool layer joined to an impermeable, reinforced, reflective foil facing installed over the roof frame and directly beneath the roof sheeting.

LAP The area where roof sheeting or insulation overlaps one another during installation.

OIL CANNING Undulations or waviness on the surface of otherwise flat metal sheets.

OVERHANG The part of the roof structure which extends horizontally beyond the vertical plane of the exterior wall of a building.

PARAPET A wall on the perimeter of a building that extends above the line of the eaves.

PENETRATION A protrusion; such as a pipe or duct, that goes through the roof sheeting and requires a flashing to be installed around it.

PITCH The slope of a roof or gutter; typically expressed in degrees.

PONDING The pooling of undrained water on a roof.

RAIN HEAD An external gutter pit used to connect downpipes to roof gutters and to provide an external overflow.

RIDGE The horizontal angle on the upper part of the roof where two sloped roof planes meet.

RUN-OFF The water discharge from a surface.

R-VALUE An insulation term for the value given for heat transfer resistance in a roof or wall system.

SARKING/SISALATION A water resistant vapour barrier fixed beneath roof sheeting; commonly a reflective foil.

SKILLION A single sloped roof generally separate from another roof.

SPAN The distance between roof sheeting supports.

SUMP A roof gutter pit used to connect downpipes to internal roof gutters.

SWARF Fine filings or chips of metal generated when cutting or drilling.

TENSILE STRENGTH The maximum amount of pressure a material can be subjected to before breaking.

THERMAL EXPANSION/CONTRACTION The increase or reduction in material due to changes in temperature.

VALLEY The area where two adjoining roof planes intersect creating a V-shaped gully.

VENT An opening which allows air to exit a space.

VENT RIDGE A roof accessory that runs along the roof peak allowing air to enter and exit the roof.

WATER CARRYING CAPACITY A measurement that states the max. amount of water a roof can carry.

WIND LOAD CAPACITY A measurement that states the max. amount of wind speed and associated pressures a building can withstand without failure.

Colorbond® ROOFING & WALLING COLOUR RANGE

STANDARD RANGE

Classic Finish



Dover White™
Classic Finish SA 0.28



Surfmist®
Classic Finish SA 0.33
Ⓢ



Evening Haze®
Classic Finish SA 0.43



Southerly®
Classic Finish SA 0.40

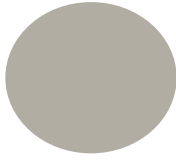

Dune®
Classic Finish SA 0.48
Ⓢ

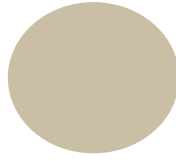

Paperbark®
Classic Finish SA 0.43

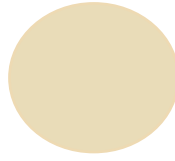

Classic Cream™
Classic Finish SA 0.33

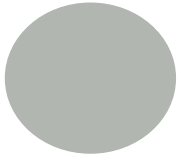

Shale Grey™
Classic Finish SA 0.44
Ⓢ

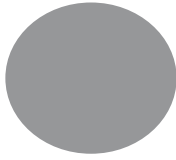

Blue Gum®
Classic Finish SA 0.57

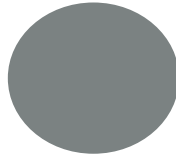

Windspray®
Classic Finish SA 0.60
Ⓢ

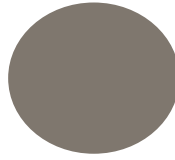

Gully®
Classic Finish SA 0.64

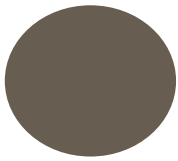

Jasper®
Classic Finish SA 0.67

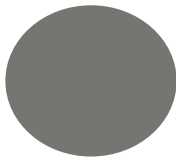

Wallaby®
Classic Finish SA 0.64
Ⓢ

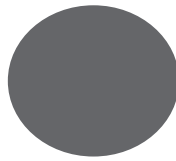

Basalt®
Classic Finish SA 0.67

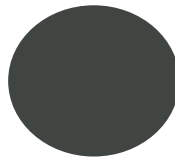

Woodland Grey®
Classic Finish SA 0.70
Ⓢ

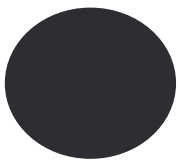

Monument®
Classic Finish SA 0.73
Ⓢ

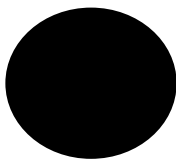

Night Sky®
Classic Finish SA 0.95

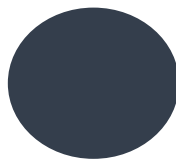

Ironstone®
Classic Finish SA 0.73

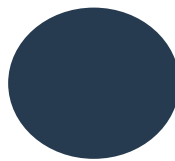

Deep Ocean®
Classic Finish SA 0.74

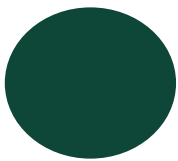

Cottage Green®
Classic Finish SA 0.73

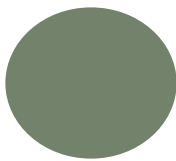

Pale Eucalypt®
Classic Finish SA 0.60

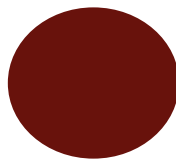

Manor Red®
Classic Finish SA 0.70

MATT RANGE

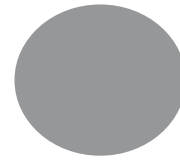

Blue Gum®
Classic Finish SA 0.57

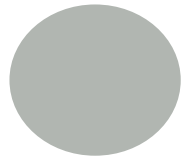

Shale Grey™
Classic Finish SA 0.44



Surfmist®
Classic Finish SA 0.33

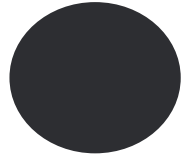

Monument®
Classic Finish SA 0.73

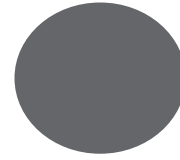

Basalt®
Classic Finish SA 0.67

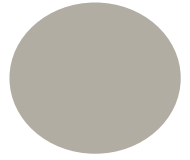

Dune®
Classic Finish SA 0.48

The COLORBOND® steel colours shown have been reproduced to represent actual product colours as accurately as possible. However, we recommend checking your chosen colour against a sample of the product before specifying as varying light conditions and limitations of the printing process may affect colour tones. COLORBOND®, BlueScope, the BlueScope brand mark and ® colour names are registered trade marks of BlueScope Steel Ltd. ™ colour names are trademarks of BlueScope Steel Ltd.

Ⓢ Available in COLORBOND® Ultra steel for coastal and industrial environments .

SA = Solar Absorptance. Solar Absorptance is a measure of how much of the sun's heat a material absorbs. Choosing a colour with a lower SA is a cooler option and may help you meet building regulations such as NCC or BASIX. These are nominal values based on new product and measured in accordance with ASTM E 903-96.

MATERIAL FINISHES

COLORBOND® STEEL

COLORBOND® steel is developed for, and therefore more resilient to, the intense sunlight and temperatures typical of Australian environments. BlueScope scientists have tested COLORBOND® steel in some of Australia's harshest climates. COLORBOND® steel is pre-painted for exterior roofing and walling. Painting complies with AS/NZS 2728:2013 and the steel base is an aluminium/zinc alloy-coated steel which complies with AS 1397:2011. Minimum yield strengths are G550 (550 MPa), or G300 (300 MPa) depending on profile. Minimum coating mass is AM100 (100 g/m²).

ZINCALUME® STEEL

Next generation ZINCALUME® steel's patented Activate™ technology introduces magnesium into the aluminium/zinc alloy coating. This improves the galvanic protection by activating the aluminium. The result is a tougher protective coating that is more resistant to scratches and scuffs encountered during the construction process. ZINCALUME® steel complies with AS 1397:2011. Material is G550, AM125 (550 MPa minimum yield stress, 125 g/m² minimum coating mass).

COLORBOND® ULTRA STEEL

While standard COLORBOND® steel will suit most home designs and locations, BlueScope also make specialist grades suited to more demanding environments, like those by the sea or in areas prone to industrial or chemical fumes and fallout. COLORBOND® Ultra is pre-painted steel for severe coastal or industrial environments, (generally within 100 - 200m of the source). The painting complies with AS/NZS 2728:2013 and the steel base is an aluminium/zinc alloy-coated steel which complies with AS 1397:2011. Minimum yield strength is G550 (550 MPa). Minimum coating mass is AM150 (150 g/m²).

COLORBOND® METALLIC STEEL

The COLORBOND® Metallic steel range features an innovative paint technology that boosts its signature lustre effect. The paint type and production method strategically places particles in the paint system to optimise light penetration and colour reflectivity to increase brilliance.

SUPERDURA® STAINLESS STEEL

SUPERDURA® Stainless is a pre-painted steel for severe coastal or industrial environments. The painting complies with AS/NZS 2728:2013 and the steel base is a stainless steel which complies with AISI/ASTM Type 430; UNS No. S43000 conforming to AS 1397.

GALVSPAN® STEEL

GALVSPAN® steel has been specifically developed for purlins and girts, and is cold formed into a wide range of sizes. Metroll purlins, girts and other structural products are manufactured from hi-tensile galvanised steel (G450, G500 or G550), with a minimum Z350 galvanised coating (350 g/m²) conforming to AS 1397.

FIVE LAYERS OF PROTECTION

Manufactured in Australia to Australian Standards (AS 1397 and AS/NZS 2728), and tested in some of the harshest Australian conditions over the last 50 years, genuine COLORBOND® steel is far more than just 'paint on steel'.

The steel base is manufactured to meet relevant Australian standards ensuring strict adherence to the required grade and strength. The base is then coated in BlueScope's industry leading metallic coating incorporating Activate® technology to provide enhanced corrosion resistance.

A thin pre-treatment layer is applied to optimise the adhesion of further coatings. A corrosion inhibitive primer is baked onto the surface. A top coat of specially developed exterior grade paint is baked on and provides resistance to chipping, flaking and blistering; and to ensure the finish retains its look for longer.

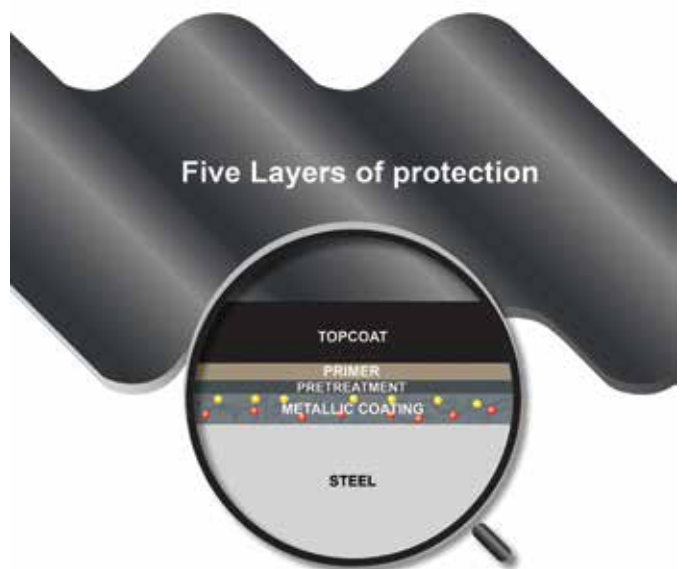

Activate® technology is not available for COLORBOND® stainless, Permagard® or steel products with a galvanised steel substrate.

MATERIAL SELECTION & CORROSION

It is important that the appropriate material is selected for application. Environmental conditions will impact the corrosive nature of each project site. These conditions include the direction of prevailing winds, rainfall amount, temperature, proximity to marine and industrial environments and the amount of exposed area not washed by natural rainfall.

BLUESCOPE® STEEL PRODUCT GUIDE FOR ROOFING IN MARINE ENVIRONMENTS

Severity	Distance from...		Recommended Steel Roofing Product
	Breaking Surf/Exposed Marine	Calm Marine	
Benign	Greater than 1 km		Zincalume® Colorbond®
Moderate	401 - 1000m	201 - 1000m	Coolmax® Metallic
Marine	201 - 400m	101 - 200m	Zincalume® Colorbond® Coolmax®
Severe Marine	101 - 200m	0 - 100m	Ultra®
Very Severe Marine	0 -100m	N/A	Stainless Steel

Notes:

- This table is sourced from BlueScope Steel TB-1A and is intended as a guide only.
- Absolute performance is subject to local conditions.
- Distance is as measured from the high-water mark.
- Applies to salt marine environments only. Contact BlueScope Steel for installations subject to heavy industrial conditions or internal humidity.
- Refer to BlueScope TB-35 for further information on marine classifications.

MATERIAL COMPATIBILITY TABLES

Roof or Rainwater Material	Direct Material Contact									Drainage from Upper Surface to Lower Surface									
	Accessory, Fastener or Upper Surface									Accessory, Fastener or Upper Surface									
	ZINCALUME®	Galvanised	Zinc	COLORBOND® Steel	SUPERDURA® Stainless Steel	Stainless Steel	Aluminium Alloys	Copper & Alloys	Lead	ZINCALUME®	Galvanised	Zinc	COLORBOND® Steel	SUPERDURA® Stainless Steel	Stainless Steel	Aluminium Alloys	Copper & Alloys	Lead	Roof Tiles, Glass, Plastic
ZINCALUME®	✓	✓	✓	✓	✗	✗	✓	✗	✗	✓	✓	✓	✓	✓	✓	✓	✗	✗	✓
Galvanised	✓	✓	✓	✓	✗	✗	✓	✗	✗	✗	✓	✓	✗	✗	✗	✗	✗	✓	✗
Zinc	✓	✓	✓	✓	✗	✗	✓	✗	✗	✗	✓	✓	✗	✗	✗	✗	✗	✓	✗
COLORBOND® Steel	✓	✓	✓	✓	✗	✗	✓	✗	✗	✓	✓	✓	✓	✓	✓	✓	✗	✗	✓
SUPERDURA® Stainless Steel	✗	✗	✗	✗	✓	✓	✗	✗	✗	✓	✓	✓	✓	✓	✓	✓	✓	✓	✓
Stainless Steel	✗	✗	✗	✗	✓	✓	✗	✗	✗	✓	✓	✓	✓	✓	✓	✓	✓	✓	✓
Aluminium Alloys	✓	✓	✓	✓	✗	✗	✓	✗	✗	✓	✓	✓	✓	✓	✓	✓	✗	✗	✓
Copper & Alloys (C&A)	✗	✗	✗	✗	✗	✗	✗	✓	✗	✓	✓	✓	✓	✓	✓	✓	✓	✓	✓
Lead (L)	✗	✗	✗	✗	✗	✗	✗	✓	✓	✓	✓	✓	✓	✓	✓	✓	✓	✓	✓

CORROSIVE PATH

Coated steel products can be damaged by contact with or run-off from some metals, treated timbers and chemicals. If any of the two metals listed here are in contact or a run-off situation, the metal higher in the table will corrode to protect the metal lower in the table. A simple rule to note is to remember that you can run water downhill but not up, e.g. Zinc to Copper is fine but Copper to Zinc is not.



Magnesium
Zinc
Zincalume®
Aluminium
Cadmium
Steel
Lead
Tin
Nickel
Brass
Copper



NEVER USE BLACK LEAD PENCILS

Black lead pencils can be a problem, not because they have lead in them, but rather because they haven't any lead in them.

Lead pencils are now made from graphite and clay; and graphite is a form of carbon. When placed in contact with most metals, this creates an electric cell when wet. This cell acts like a battery and eats away at the metal surface leaving an indelible mark. The trick is to use any other coloured pencil - except black.

ZINCALUME® OR GALVANISED?

Not sure if it's ZINCALUME® or galvanised steel? If in doubt submit the surface to the acid test:

1. Clean the surface area of the steel.
2. Apply a single drop of spirits of salts (muriatic or hydrochloric acid) at about 1/3 strength.
3. If the surface stays clean the material is galvanised, if it turns black it is ZINCALUME®.

ROOFING & WALLING PRODUCT TABLES

PROFILE	BMT mm	Steel Base MPa	Colorbond® Mass Kg/m ²	Zinc Mass Kg/m ²	Cover Width mm	Profile Depth mm	Minimum Pitch °	Max. Spans mm*		Overhang mm**	
								End	Internal	Plain	Stiffened
ROOFING											
Corodek®	0.42	G550	4.30	4.23	762	16	5 (1 in 12)	900	1200	200	250
	0.48	G550	4.88	4.81	762	16	5 (1 in 12)	1300	1700	250	250
	0.60	G300	5.95	5.88	762	16	5 (1 in 12)	1600	1800	200	250
Hi-Deck 650®	0.42	G550	5.04	4.96	650	50	1 (1 in 50)	2550	3200	200	500
	0.48	G550	5.72	5.64	650	50	1 (1 in 50)	3100	3900	250	550
Metlok 700®	0.42	G550	4.68	4.61	700	40	1 (1 in 50)	1800	2200	150	450
	0.48	G550	5.32	5.24	700	40	1 (1 in 50)	2200	2800	200	500
Metrospan®	0.42	G550	4.68	4.61	700	24	2 (1 in 30)	1800	2400	200	400
	0.48	G550	5.32	5.24	700	24	2 (1 in 30)	2200	3000	250	500
Trimclad®	0.42	G550	4.30	4.23	762	29	2 (1 in 30)	1350	1900	150	300
	0.48	G550	4.88	4.81	762	29	2 (1 in 30)	1900	2600	200	350
WALLING											
Corodek®	0.42	G550	4.30	4.23	762	16		2200	2700	200	300
	0.48	G550	4.88	4.81	762	16		2400	2700	250	350
	0.60	G300	5.95	5.88	762	16		2200	2700	200	300
Hi-Deck 650®	0.42	G550	5.04	4.96	650	50		3300	4150	250	500
	0.48	G550	5.72	5.64	650	50		3600	4500	300	550
Metlok 700®	0.42	G550	4.68	4.61	700	40		2200	2200	200	450
	0.48	G550	5.32	5.24	700	40		2400	2700	250	500
Metrib®	0.35	G550	3.25	3.19	850	4		1000	1250	100	100
	0.42	G550	3.86	3.80	850	4		1000	1250	150	150
	0.48	G550	4.38	4.32	850	4		1000	1300	150	150
Metroclad®	0.35	G550	3.20	3.14	864	11		1300	1650	100	150
	0.42	G550	3.79	3.73	864	11		1400	1750	150	200
Metrospan®	0.42	G550	4.68	4.61	700	24		2400	3000	200	400
	0.48	G550	5.32	5.24	700	24		2400	3000	250	500
Mini Corodek®	0.42	G550	3.97	3.91	825	6		1150	1450	100	100
	0.48	G550	4.51	4.45	825	6		1150	1450	125	125
Trimclad®	0.35	G550	3.62	3.56	762	29		2400	3000	150	250
	0.42	G550	4.30	4.23	762	29		2400	3000	200	300
	0.48	G550	4.88	4.81	762	29		2400	3000	250	350

NOTES: *Maximum Spans are based on N2 Wind Category and 1.5mm substrate.

**Minimum Overhang is 50mm.

*Plain Overhangs limited to 20% of adjacent end span.

**Stiffened Overhangs limited to 33% of adjacent end span.

SHEET COVERAGE BY PROFILE

METROSPAN®
Cover: 700mm

Roof Width (m)	Sheets	Sheets	Cover (m)
3	5	3	2.1
4	6	4	2.8
5	8	5	3.5
6	9	6	4.2
7	10	7	4.9
8	12	8	5.6
9	13	9	6.3
10	15	10	7.0
11	16	11	7.7
12	18	12	8.4
13	19	13	9.1
14	20	14	9.8
15	22	15	10.5
16	23	16	11.2
17	25	17	11.9
18	26	18	12.6
19	28	19	13.3
20	29	20	14.0

CORODEK®
Cover: 762mm

Roof Width (m)	Sheets	Sheets	Cover (m)
3	4	3	2.3
4	6	4	3.0
5	7	5	3.8
6	8	6	4.6
7	10	7	5.3
8	11	8	6.1
9	12	9	6.9
10	14	10	7.6
11	15	11	8.4
12	16	12	9.1
13	18	13	9.9
14	19	14	10.7
15	20	15	11.4
16	21	16	12.2
17	23	17	13.0
18	24	18	13.7
19	25	19	14.5
20	27	20	15.2

METROCLAD®
Cover: 850mm

Roof Width (m)	Sheets	Sheets	Cover (m)
3	4	3	2.6
4	5	4	3.4
5	6	5	4.3
6	8	6	5.1
7	9	7	6.0
8	10	8	6.8
9	11	9	7.7
10	12	10	8.5
11	14	11	9.4
12	15	12	10.2
13	16	13	11.1
14	17	14	11.9
15	18	15	12.8
16	20	16	13.6
17	21	17	14.5
18	22	18	15.3
19	23	19	16.2
20	24	20	17.0

METLOK 700®
Cover: 700mm

Roof Width (m)	Sheets	Sheets	Cover (m)
3	5	3	2.1
4	6	4	2.8
5	8	5	3.5
6	9	6	4.2
7	10	7	4.9
8	12	8	5.6
9	13	9	6.3
10	15	10	7.0
11	16	11	7.7
12	18	12	8.4
13	19	13	9.1
14	20	14	9.8
15	22	15	10.5
16	23	16	11.2
17	25	17	11.9
18	26	18	12.6
19	28	19	13.3
20	29	20	14.0

TRIMCLAD®
Cover: 762mm

Roof Width (m)	Sheets	Sheets	Cover (m)
3	4	3	2.3
4	6	4	3.0
5	7	5	3.8
6	8	6	4.6
7	10	7	5.3
8	11	8	6.1
9	12	9	6.9
10	14	10	7.6
11	15	11	8.4
12	16	12	9.1
13	18	13	9.9
14	19	14	10.7
15	20	15	11.4
16	21	16	12.2
17	23	17	13.0
18	24	18	13.7
19	25	19	14.5
20	27	20	15.2

METRIB®
Cover: 850mm

Roof Width (m)	Sheets	Sheets	Cover (m)
3	4	3	2.6
4	5	4	3.4
5	6	5	4.3
6	8	6	5.1
7	9	7	6.0
8	10	8	6.8
9	11	9	7.7
10	12	10	8.5
11	14	11	9.4
12	15	12	10.2
13	16	13	11.1
14	17	14	11.9
15	18	15	12.8
16	20	16	13.6
17	21	17	14.5
18	22	18	15.3
19	23	19	16.2
20	24	20	17.0

FASTENER SELECTION GUIDES















CORRUGATED PROFILES







	NON-CYCLONIC FIXING		CYCLONIC FIXING		
	Valley Fix	Crest Fix	Valley Fix	Crest Fix	Ridge Cap Fix
Fix to Timber Supports	 RoofZIPS® M6 - 11 x 25 Hd/Seal 6-030-3308-3C4	 RoofZIPS® M6 - 11 x 50 Hd/Seal 6-030-3306-1C4	 14 - 10 x 25mm Hex Hd SL Type 17 6-030-3007-4C4	 14 - 10 x 50mm Hex Hd Roof-Lok® Type 17 6-030-3633-2C4	 14 - 10 x 50mm 25mm Multiseal Assy Type 17 6-030-3093-2C4
Fix to Metal Supports 0.42 - 1.5mm	 RoofZIPS® M6 - 11 x 25 Hd/Seal 6-030-3308-3C4	 RoofZIPS® M6 - 11 x 50 Hd/Seal 6-030-3306-1C4	 RoofZIPS® M6 - 11 x 25 Hd/Seal 6-030-3308-3C4	 RoofZIPS® M6.5 - 12 x 55mm Roof-lok® Cyl Assy 6-030-3331-1C4	 RoofZIPS® M6.5 - 12 x 55mm Multiseal Assy 6-030-3333-3C4
Fix to Steel Supports 1.5 - 4.5mm	 10 - 16 x 16mm Hex Hd SL Tek® 6-310-3117-5Z4	 M5.5 x 39mm AutoTek® 6-310-3637-7C4	 14 - 10 x 25mm Hex Hd SL Metal Tek® 6-310-3637-7C4	 14 - 10 x 53mm Hex Hd Roof-Lok® Metal Tek® 6-310-3162-2C4	 14 - 10 x 53mm 25mm Ridge Cap Assy Metal Tek® 6-310-3150-2C4

SQUARE RIB PROFILES



	NON-CYCLONIC FIXING		CYCLONIC FIXING		
	Valley Fix	Crest Fix	Valley Fix	Crest Fix	Ridge Cap Fix
Fix to Timber Supports	 RoofZIPS® M6 - 11 x 25 Hd/Seal 6-030-3308-3C4	 RoofZIPS® M6 - 11 x 65mm 6-030-3307-2C4	 14 - 10 x 25mm Hex Hd Seal Type 17 6-031-3007-4C4	 14 - 10 x 65mm Roof-Lok® Type 17 6-030-3655-7C4	 14 - 10 x 65mm Multiseal Assy Type 17 6-030-3088-6C4
Fix to Metal Supports 0.42 - 1.5mm	 RoofZIPS® M6 - 11 x 25 Hd/Seal 6-030-3308-3C4	 RoofZIPS® M6 - 11 x 50 Hd/Seal 6-030-3306-1C4	 RoofZIPS® M6 - 11 x 25 Hd/Seal 6-030-3308-3C4	 RoofZIPS® M6.5 - 12 x 55mm Roof-lok® 6-030-3332-2C4	 RoofZIPS® M6.5 - 12 x 55mm Multiseal Assy 6-030-3333-3C4
Fix to Steel Supports 1.5 - 4.5mm	 10 - 16 x 16mm Hex Hd SL Tek® 6-310-3117-5Z4	 M5.5 x 50mm AutoTek® 6-310-3579-4C4	 14 - 10 x 25mm Hex Hd SL Metal Tek® 6-310-3323-5C4	 14 - 10 x 50mm Roof-Lok® Metal Tek® 6-310-3164-2C4	 14 - 10 x 53mm 25mm Ridge Cap Assy Metal Tek® 6-310-3150-2C4

FASTENER SELECTION GUIDES

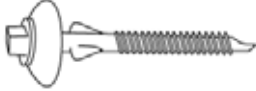
Approx. Fasteners per m ²			
Mini Corodek®	5 - 6	Fix to Timber Supports & Steel 1 - 3mm BMT  M4.8 x 25mm RippleZIPS®	
Metlok 700®	3 per clip	Fix to Timber Supports  #12 Hex Head Type 17 x 25mm Add 10mm for softwood	Fix to Steel < 1.5mm BMT #12 Hex Head Zip Screws x 25mm
			Fix to Steel > 1.5mm BMT #12 Hex Head Self Drilling Screws x 25mm
Roofing Battens	8	Fix to Timber Supports  M5.5 x 40mm Hex Head BattenZIPS®	Fix to Steel 1 - 4mm BMT  12 - 14 x 20mm Hex Head Metal Tek®
Polycarbonate Roofing	See manufacturers recommendation	Fix: Roof profile heights 16 to 24mm to timber battens; Fix roof profile heights 16 to 29mm to metal batten & purlins up to 1.6mm  PolyZIPS® M6.5 - 14 x 50mm Hex Head	
Fibreglass Roofing	See manufacturers recommendation	Fix roof profile heights 18 to 29mm to purlins 1.2 to 5mm Fibreglass Tek® M6.5 - 14 x 65mm Hex Head	Fix roof profile heights 40 to 62.5mm to purlins 1.2 to 5mm Fibreglass Tek® M6.5 - 14 x 85mm Hex Head

All fasteners to be installed as per manufacturers recommendations. This guide outlines only the most frequently used screw assemblies. The screw length may vary depending on the actual profile and the type of insulation system used. These recommendations should always be considered in conjunction with the roof manufacturers fixing specifications. Self drilling and tapping screws must comply with AS 3566.

FASTENER QUANTITY GUIDE

PROFILE	Fasteners per sheet width	Sheet Cover (mm)	FASTENERS PER m ²					
			Typical Support Spacings (mm)					
			450	600	900	1200	1500	1600
Corodek®	3	762	9	7	5	4	3	3
	5		15	11	8	6	5	4
Trimclad®	4	762	12	9	6	5	4	3
Metrospan®	3	700	10	8	5	4	3	3
	4		13	10	6	5	4	3
Metlok 700®	3 per clip	700			2	1	1	1
Metroclad®	4	850	11	8	6	4	4	3
Mini Corodek®	6	825	17	13	9	7	5	5
	11		30	22	15	11	9	7
Metrib®	4	850	11	8	6	4	4	3
	8		21	16	10	8	6	6

SIDE LAPS

It is considered good practice to use fasteners on side laps, although these are generally not necessary when the sheeting is supported as indicated in maximum span tables or for roof spans under 900mm and wall cladding spans under 1200mm. Side lap fastening should be considered if the weather resistance of the joint is questionable for any reason.

DRAINAGE & OVERFLOW

MAXIMUM ROOF RUNS (m) FOR SLOPES & RAINFALL INTENSITIES

PROFILE	Intensity mm/hr	ROOF SLOPE					
		1 in 50 1°	1 in 30 2°	1 in 20 3°	1 in 12 5°	1 in 7.5 7.5°	1 in 6 10°
Corodek®	100				47	47	51
	150				27	32	35
	200				20	24	26
	250				16	19	21
	300				13	16	17
	400				10	12	13
Hi Deck 650®	100	143	480	209	256		348
	150	95	120	139	171		232
	200	71	90	104	128		174
	250	57	72	83	102		139
	300	47	60	69	85		116
	400	35	45	52	64		87
Metlok 700®	100	316	398	462	567	676	769
	150	211	265	308	378	450	513
	200	158	199	231	284	338	385
	250	127	159	185	227	270	308
	300	105	133	154	189	225	256
	400	79	99	116	142	169	192
Metrospan®	100		97	110	131		168
	150		65	73	87		112
	200		49	55	65		84
	250		39	44	52		67
	300		32	37	44		56
	400		24	28	33		42
Trimclad®	100		220	257	320	382	439
	150		146	172	214	255	293
	200		110	129	160	191	220
	250		88	103	128	153	176
	300		73	86	107	127	146
	400		55	64	80	96	110

- Rainwater run-off and drainage capacity may place some limitations on the total length of a sheet run and must be considered during the design and construction phase of a project.
- The total length of roof sheeting which shall include ends laps, expansion joints or steps and draining the roof in one direction, shall be considered a single roof run.
- Thermal expansion must also be considered.
- Maximum production and transportation lengths may limit availability.

RAINFALL DURATION INTENSITIES (mm/Hr)

		5 min. RAINFALL INTENSITY				5 min. RAINFALL INTENSITY		
		Once in 20 years	Once in 100 years			Once in 20 years	Once in 100 years	
ACT	Canberra	143	193	SA	Adelaide	124	184	
	Gungahlin	137	179		Gawler	110	158	
	Tuggeranong	148	210		Mt. Gambler	103	144	
NSW	Albany	139	180		Murray Bridge	120	178	
	Broken Hill	143	219		Port Augusta	133	199	
	Goulburn	121	156		Port Pirie	122	181	
	Kiama	226	319		Yorke town	155	166	
	Newcastle	226	319		TAS	Burnie	128	180
	Orange	142	186			Flinders Island	122	165
	Sydney	200	262	Hobart		85	116	
	Avalon	206	278	Launceston		90	121	
	Campbeltown	167	222	Queenstown		94	120	
	Penrith	180	244	St Marys	146	203		
	Windsor	175	233	VIC	Ballarat	131	188	
	Tweed Heads	252	330		Benalla	146	194	
	Wollongong	217	308		Geelong	102	144	
	NT	Alice Springs	166		239	Horsham	120	173
Darwin		233	274		Lake Entrance	145	198	
Katherine		216	250		Melbourne	132	187	
QLD	Bamaga	252	298		Hastings	117	145	
	Brisbane	234	305		Sorrento	106	140	
	Ipswich	211	278		Mildura	142	218	
	Victoria Point	245	320		Stawell	130	186	
	Bundaberg	265	340	WA	Albany	125	178	
	Cairns	229	278		Broome	232	287	
	Concurry	218	278		Bunbury	147	199	
	Innisfail	248	301		Derby	211	256	
	Mackay	250	316		Geraldton	138	193	
	Mt. Isa	199	260		Kalgoorlie	137	204	
	Noosa Heads	258	331		Perth	130	172	
	Rockhampton	229	300		Joondalup	133	180	
	Toowoomba	203	268		Midland	122	163	
	Townsville	235	300		Port Headland	168	230	
	Weipa	239	283		Tom Price	138	182	

Source: National Construction Code. Table 3.5.2.1

GUTTER OVERFLOW

RAINWATER OVERFLOW PROVISIONS

The NCC 2016 Part 3.5.2 sets out the appropriate performance requirements for overflow measures of eave and valley gutters. This was updated in May 2016 and incorporates the requirements for rainfall intensities for 1 in 20 year and 1 in 100 year intervals in locations across Australia.

It is important that the drainage system diverts water away from the building. Part 3.5.2 of the NCC 2016 sets out the acceptable construction practice and gives consideration to materials, gutter selection, gutter installation and downpipe size and installation. The code also provides detail on rainfall duration intensities, gutter and downpipe selection, overflow volumes and acceptable overflow measures both continuous and dedicated.

It is important to note that a combination of overflow measures may be required in order to achieve a complying drainage system. As high fronted gutters have become very popular, overflow systems must be considered in the totality of the drainage system as relying on gutter capacity alone may not be sufficient.

DESIGNER RESPONSIBILITY

The designer may be the builder, hydraulic engineer, architect, building designer, roofing and guttering contractor or home owner. It is up to the designer to design a complete rainwater drainage system that meets the relevant requirements of the NCC Building Code and relevant Australian Standards. Designers should take note of AS/NZS 3500.3 and AS/NZS 3500.5.

Broadly, the steps a roof drainage designer takes are as follows:

- Ascertain duration of rainfall intensity.
- Consider the roof design, roof catchment area, slope, number and positions of downpipes, length of gutter, ridge to gutter length etc.
- Calculate the overflow volume.
- Select downpipes, gutters and overflow measures that are suitable based on the required overflow volume.

INSTALLER RESPONSIBILITY

The installer is responsible for installing the rainwater drainage system as per the design provided by the designer. Section 3.5.2.4 of the NCC 2016 sets out the minimum requirements for the installation of gutters.

HOMEOWNER RESPONSIBILITY

A rainwater drainage system is only as good as the maintenance of the system. Blocked gutters, downpipes or other overflow items will negatively impact on the performance of the drainage system. The homeowner is responsible for ensuring basic maintenance of the system is carried out at regular intervals.

RAINWATER OVERFLOW DESIGN & PROVISION

NCC: Table 3.5.2.4 ACCEPTABLE OVERFLOW MEASURES

Note: Extracted directly from the NCC. (L/s/m = Litres per second per metre)

TABLE A: ACCEPTABLE CONTINUOUS OVERFLOW MEASURES

	Overflow Capacity (L/s/m)	
<p>Front face slotted gutter with;</p> <p>a. A minimum slot opening area of 1200mm² per metre gutter; and</p> <p>b. The lower edge of the slots is installed a minimum of 25mm below the fascia.</p>	0.50	
<p>Controlled back gap with;</p> <p>a. A permanent minimum 10mm spacer installed between the gutter back and fascia; and</p> <p>b. One spacer per bracket, with the spacer not more than 50mm wide; and</p> <p>c. The back of the gutter installed a minimum of 10mm below the fascia.</p>	1.50	
<p>Controlled front bead height;</p> <p>a. The front bead of the gutter installed a minimum 10mm below the top of the fascia.</p>	1.50	

TABLE B: ACCEPTABLE DEDICATED OVERFLOW MEASURES PER DOWNPIPE

<p>End-stop weir with;</p> <p>a. A minimum clear width of 100mm; and</p> <p>b. The weir edge installed a minimum of 25mm below the fascia.</p>	0.50	
<p>Inverted nozzle installed within 500mm of a gutter high point with;</p> <p>a. A minimum nozzle size of 100mm x 50mm positioned lengthways in the gutter; and</p> <p>b. The top of the nozzle installed a minimum of 25mm below the top of the fascia.</p>	1.2	
<p>Front race weir with;</p> <p>a. A minimum clear width of 200mm; and</p> <p>b. A minimum clear height of 20mm; and</p> <p>c. The weir edge installed a minimum of 25mm below the top of the fascia.</p>	1.0	
<p>Rainhead with;</p> <p>a. A 75mm diameter hole in the outward face of the rainhead; and</p> <p>b. The centreline of the hole positioned 100mm below the top of the fascia.</p>	3.5	

METROLL GUTTER PROFILES

There may be variations in dimensions across Metroll's manufacturing locations. Check with your local Metroll branch for dimensions, lead times and availability.

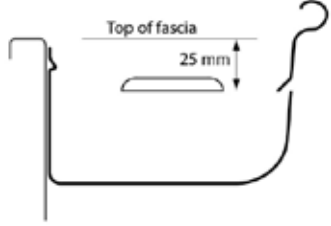
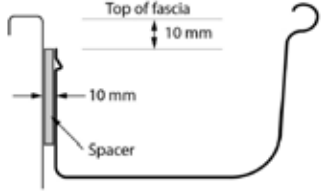
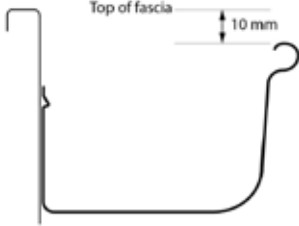
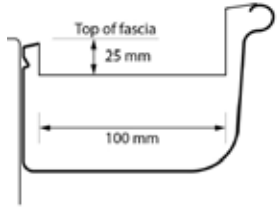
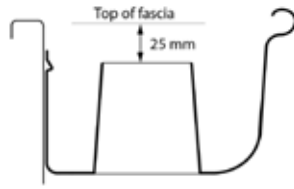
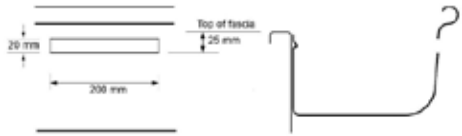
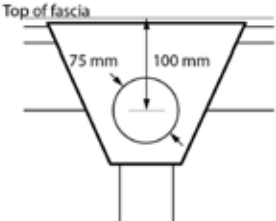
TCA = Total Cross Sectional Area

ECA = Effective Cross Sectional Area. ECA is calculated as per AS/NZS 2179:2014 and is 10mm below the overflow level.

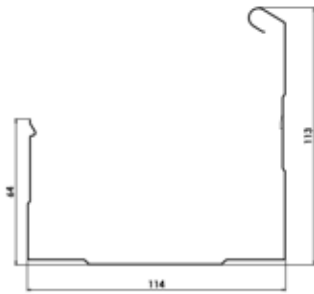

METROLINE SQUARE GUTTER QLD, NSW, VIC	TCA mm²	ECA mm²
Standard	6,971	5,874
Slotted	6,305	5,202

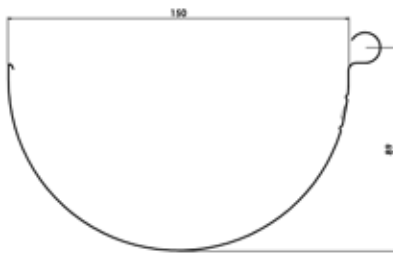

150 HALF ROUND GUTTER QLD, NSW, VIC	TCA mm²	ECA mm²
Standard	9,791	8,303
Slotted	6,232	4,811

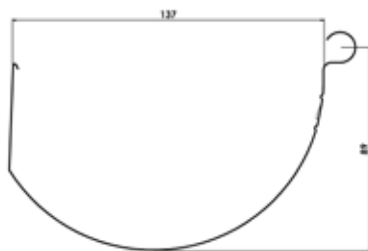

SKYLINE GUTTER* QLD, NSW, VIC	TCA mm²	ECA mm²
Standard	9,364	8,005
Slotted	6,039	4,706

* Suitable for use with Graptor Bracket.

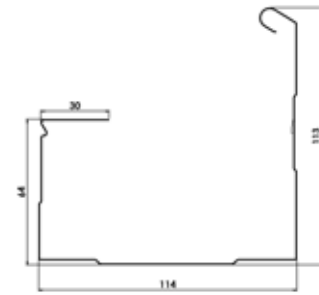

METROLINE FASCIA GUTTER QLD, VIC	TCA mm²	ECA mm²
Standard	6,971	5,874
Slotted	6,305	5,202

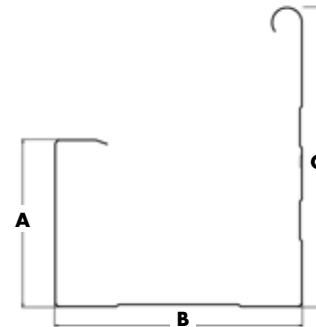

SQUARELINE GUTTER

VIC, WA

MODEL	DIMENSIONS mm			ECA mm ²		TCA mm ²	
	A	B	C	STD	SLTD	STD	SLTD
WA	81	120	145	8,302	6,734	9,471	7,923
Standard VIC	65	127	122	6,800	5,800	8,000	7,100
Commercial VIC	83	125	136	-	8,210	-	9,450
Fascia Gutter VIC	60	127	121	6,310	5,840	7,570	7,100

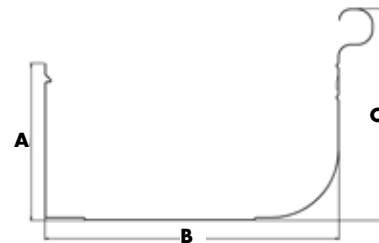

HIGH FRONT QUAD GUTTER

NT, QLD, NSW, VIC, TAS, SA

MODEL	DIMENSIONS mm			ECA mm ²		TCA mm ²	
	A	B	C	STD	SLTD	STD	SLTD
115*	61	115	90	5,529	4,763	6,660	5,895
125*	68	107	94	5,837	4,939	6,895	5,991
150**	68	130	98	7,298	5,852	8,578	7,137
175	71	160	99	9,389	7,617	10,970	9,204

* Suitable for use with Graptor Bracket.

** 150 model suitable use with Graptor Bracket in QLD only

GRAPTOR BRACKET

The Graptor bracket offers a compliant solution for the mandatory gutter overflow requirements of the NCC 2019, Part 3.5.2, by way of a controlled back gap between the fascia and the back of the gutter. The Graptor is suitable for use with the Skyline Gutter, 115 High Front Quad Gutter, 125 High Front Quad Gutter, 150 High Front Quad Gutter (QLD only) and Big M Gutter (QLD).



METROLL GUTTER PROFILES

TCA = Total Cross Sectional Area

ECA = Effective Cross Sectional Area. ECA is calculated as per AS/NZS 2179:2014 and is 10mm below the overflow level.

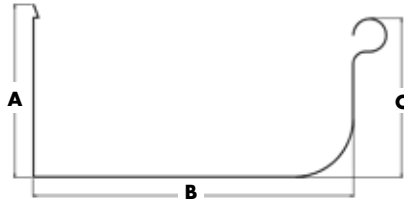

LOW FRONT QUAD GUTTER				QLD, Newcastle	
MODEL	DIMENSIONS mm			ECA mm ²	TCA mm ²
	A	B	C	STD	STD
115	58	113	61	5,367	6,497
150	76	141	70	8,239	9,762
175	105	175	100	15,430	17,297

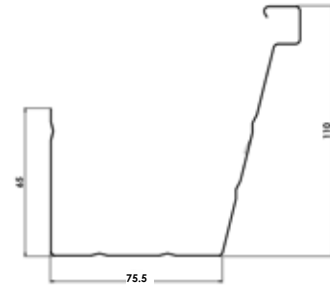

EAVESLINE GUTTER WA		TCA mm ²	ECA mm ²
Standard		5,339	4,453
Slotted		3,555	2,714

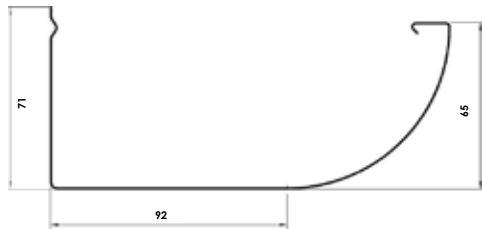

SMARTLINE GUTTER WA		TCA mm ²	ECA mm ²
Standard		9,057	7,518

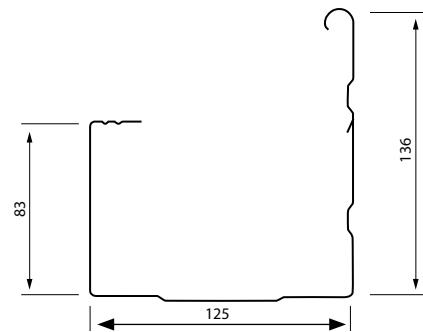

NEWCASTLE FASCIA GUTTER NSW		TCA mm ²	ECA mm ²
Standard		10,312	9,062
Slotted		9,687	8,437

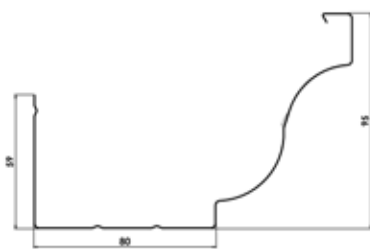

ROOFLINE COLONIAL GUTTER WA		TCA mm ²	ECA mm ²
Standard		5,849	4,729
Slotted		4,329	3,222

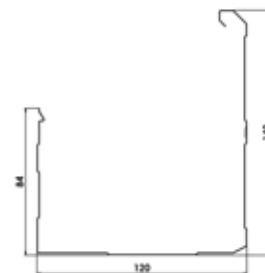

BIG M GUTTER QLD		TCA mm ²	ECA mm ²
Standard		9,727	8,564
Slotted		7,813	6,634

METROLL GUTTER PROFILES

TCA = Total Cross Sectional Area

ECA = Effective Cross Sectional Area. ECA is calculated as per AS/NZS 2179:2014 and is 10mm below the overflow level.

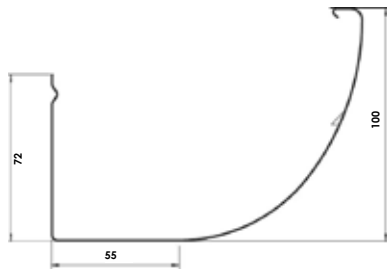

QUARTER ROUND GUTTER WA	TCA mm ²	ECA mm ²
Standard	7,849	6,567
Slotted	5,127	3,920

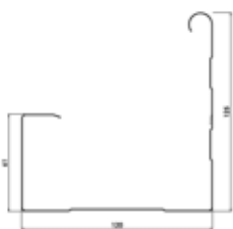

PATIOLINE

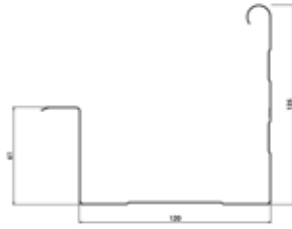

QUICKFIX

PATIOLINE & QUICKFIX GUTTERS WA	TCA mm ²	ECA mm ²
Patioline Standard	7,097	5,924
Quickfix Standard	7,108	5,918
Patioline & Quickfix Slotted	6,378	5,195

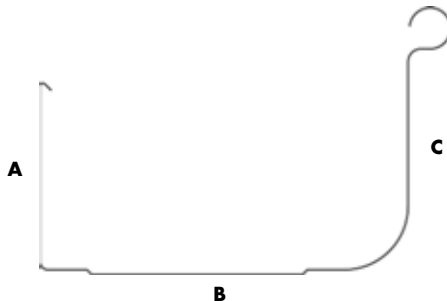

QUAD GUTTER

MODEL	DIMENSIONS mm			TCA mm ²	ECA mm ²
	A	B	C	STD	STD
115	64	110	94	5,611	4,673
125	67	130	94	7,177	5,564
150	67	160	94	8,889	6,902

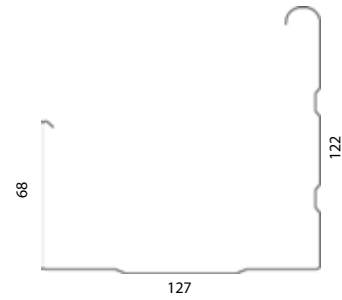

METROLINE GUTTER SA	TCA mm ²	ECA mm ²
Standard	6,071	7,331

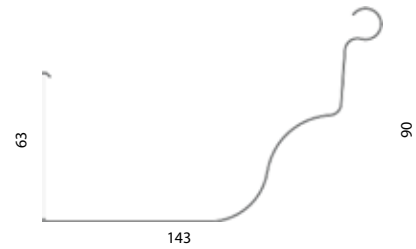

OG GUTTER SA	TCA mm ²	ECA mm ²
Standard	4,834	5,209

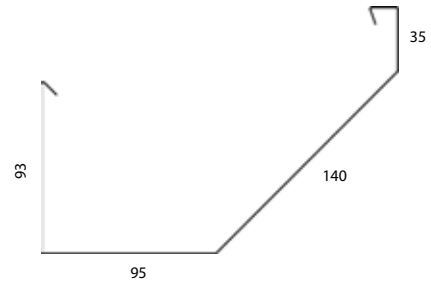

CITY GUTTER SA	ECA mm ²
Standard	11,246

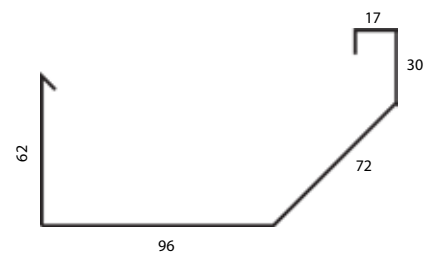

SUBURBAN GUTTER SA	ECA mm ²
Standard	7,502

ROOF PITCH & QUANTITY ESTIMATOR

IMPORTANT NOTE This detail is used for quick estimating purposes only. Exact measurements must be taken from the actual roof frame prior to ordering any roof sheeting or accessories.

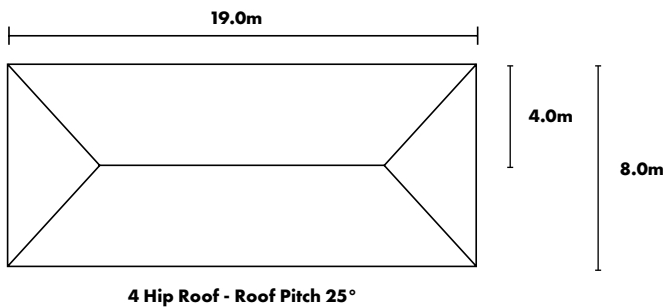

CALCULATING ROOF AREA

Multiply the length of the roof by the width and then multiply by the roof pitch factor to increase plan area.

Example: For 25° factor = 1.103
 $19 \times 8 = 152\text{m}^2$
 $152 \times 1.103 = 169.56\text{m}^2$

CALCULATING SHEET LENGTH

Measure from ridge to fascia on the plan (e.g. 4.000), multiply by factor to increase plan area.

Example: For 25° factor = 1.103
 $4 \times 1.103 = 4.412$ Lm (Rafter length)
 Add 50mm (Fall to gutter)
 Sheet Length = 4.462

CALCULATING HIP & VALLEY LENGTH

Measure from ridge to fascia on the plan (e.g. 4.000), multiply by factor to determine length of hip.

Example: For 25° factor = 1.489
 $4 \times 1.489 = 5.956$ Lm (Rafter length)
 Add 50mm (Fall to gutter)
 Hip Cover = 6.006 Lm Ridge Flashing.

Note: All ridges that run 90° or parallel to fascia can simply be scaled off roof plan for actual roof length.

ROOF PITCH °	Factor to increase plan area of Roof	Factor to determine length of Hip per units of 1 across span
1	1.000	1.414
2	1.001	1.415
3	1.001	1.415
4	1.002	1.416
5	1.004	1.417
6	1.006	1.418
7	1.008	1.420
8	1.010	1.421
9	1.012	1.423
10	1.015	1.425
11	1.019	1.428

ROOF PITCH °	Factor to increase plan area of Roof	Factor to determine length of Hip per units of 1 across span
12	1.022	1.430
13	1.026	1.433
14	1.031	1.436
15	1.035	1.439
16	1.040	1.442
17	1.046	1.447
18	1.051	1.451
19	1.058	1.456
20	1.064	1.460
21	1.071	1.465
22	1.079	1.471
23	1.086	1.477
24	1.095	1.483
25	1.103	1.489
26	1.113	1.496
27	1.122	1.503
28	1.133	1.511
29	1.143	1.519
30	1.155	1.528
31	1.167	1.537
32	1.179	1.546
33	1.192	1.556
34	1.206	1.567
35	1.221	1.578
36	1.236	1.590
37	1.252	1.602
38	1.269	1.616
39	1.287	1.630
40	1.305	1.644
41	1.325	1.660
42	1.346	1.677
43	1.367	1.694
44	1.390	1.712
45	1.414	1.732
46	1.440	1.753
47	1.466	1.775
48	1.494	1.798
49	1.524	1.823
50	1.556	1.849
51	1.589	1.877
52	1.624	1.907
53	1.662	1.939
54	1.701	1.973
55	1.743	2.010
56	1.788	2.049
57	1.836	2.091
58	1.887	2.136
59	1.942	2.184
60	2.00	2.236

QUANTITY ESTIMATOR EXAMPLES

A. How to calculate a hip roof and minimise material wastage This example uses Corodek®

To determine the quantity of roof sheets for the sample house illustrated here:

1. Check the plan for the roof type and pitch.
2. Divide 22m by the sheet cover width.
(Corodek® sheets have an effective cover of 762mm)
 $22000\text{mm} \div 762\text{mm} = 28.8 \text{ sheets} = 29 \text{ sheets.}$
3. Multiply x 2 to cover both sides of the roof = 58 sheets.
4. Length of sheets required is 4570mm. Therefore the sheeting required for this project is 58 sheets at 4570mm.
5. On an equal hip roof as shown, ordering the sheets at one length will eliminate wastage.
6. As shown in the diagram, when the sheets are cut along the hip line the surplus sheeting can be used on the reverse corner of the roof.

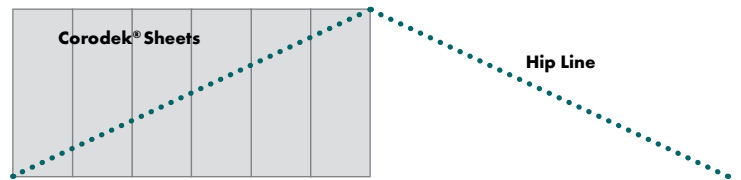
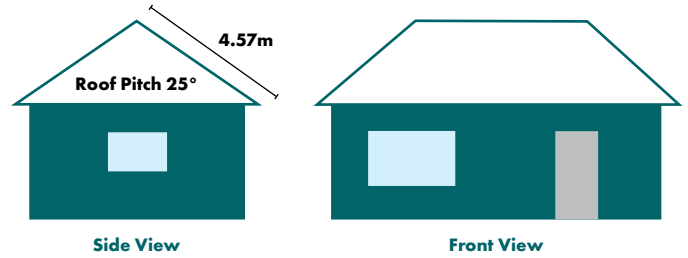
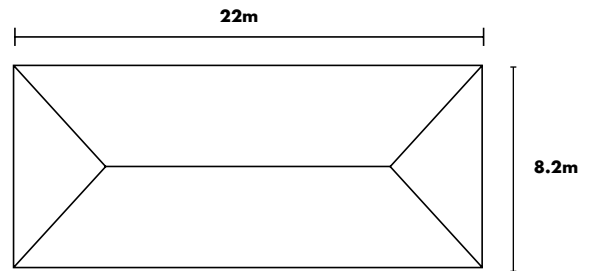

B. How to calculate an irregular sized roof and minimise material wastage

This example uses Metlok 700® sheets with an effective cover of 700mm.

1. Check the plan for the roof type and pitch.
2. To determine the quantity of roof sheets required, divide roof cover by sheet cover width
 $6000\text{mm} \div 700\text{mm} = 8.57 \text{ sheets} = 9 \text{ sheets}$
3. As per Fig. A, this roof tapers from 6530 mm to 0mm. Ensure gutter overhang and fascia thickness are added to the sheet length
 $6530\text{mm} + 70\text{mm} = 6600\text{mm}$
4. To work out the sheet steps required (Fig.B), divide the sheet length by the sheet quantity
 $6600\text{mm} \div 9 \text{ sheets} = 750\text{mm}$
5. Each sheet starting from 6600 will be 750mm shorter than the previous sheet, e.g:

Sheet 1	6600mm	Sheet 6	2850mm
Sheet 2	5850mm	Sheet 7	2100mm
Sheet 3	5100mm	Sheet 8	1350mm
Sheet 4	4350mm	Sheet 9	600mm
Sheet 5	3600mm		

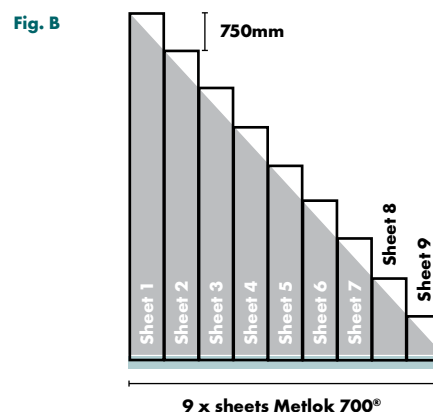
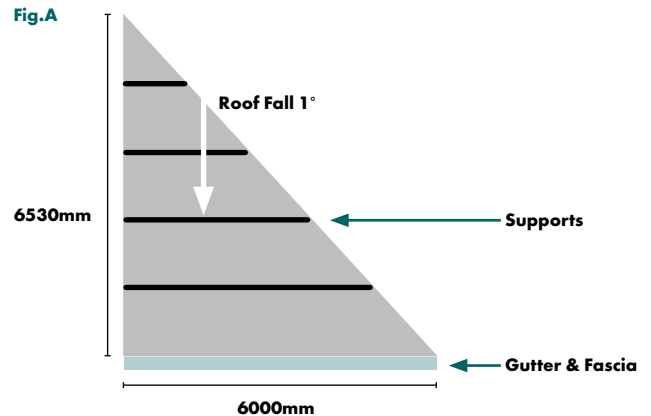

CURVING & BULLNOSING

CURVING STYLES

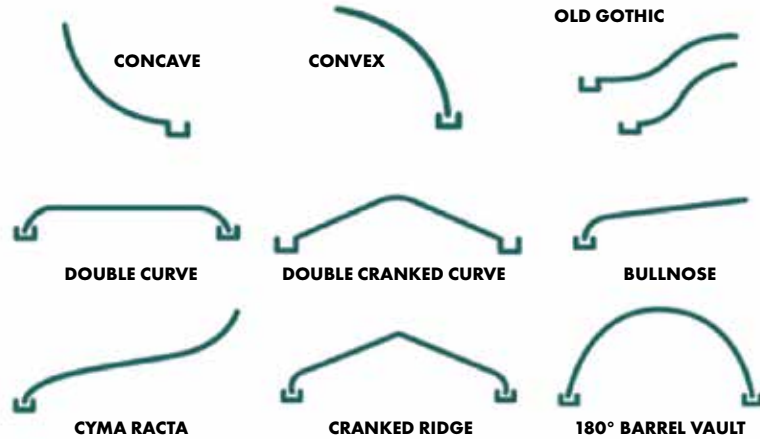

CURVING DETAILS

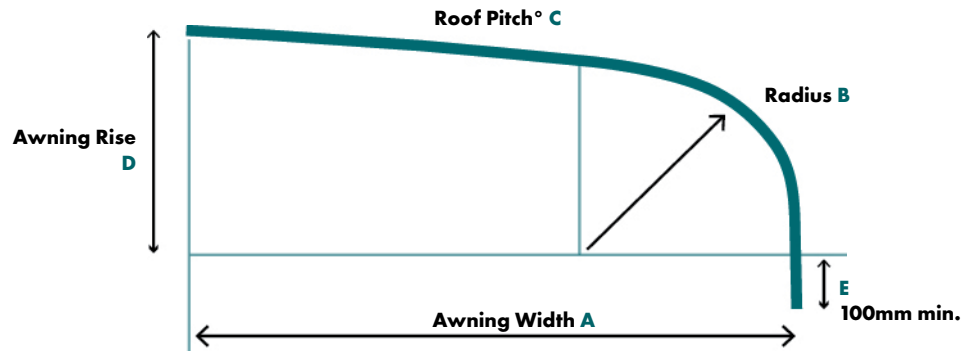

Details required when curving:

1. Awning Width (A)
2. Radius (B)
3. Roof Pitch° (C)
4. Awning Rise (D)
5. Straight Vertical Lead (E)
6. Number of sheets required
7. Sheet Length
8. Colour or Finish
9. Stipulate Colour Underside or Topside
10. Direction of Laying L to R or R to L
11. Does the bullnose sheet end lap a straight sheet? Y or N
12. Is a template supplied? Y or N

Note: Metroll takes no responsibility for variances on sheets curved from drawings. A template should be supplied to ensure accuracy. The minimum recommended curving radius is 450mm.

THERMAL EXPANSION

Change in temperature will cause all metals to expand and contract. There is a minimal effect with steel roofing and cladding, however care must be taken when long sheet runs are proposed and high temperature variations occur.

Metroll recommends the following maximum roof runs for pierce fixed roofing or cladding

Profile	Dark Colours	Light Colours
Corodek®	Up to 17m	Up to 24m
Trimclad®		
Metrospan®		

FLASHINGS

Metroll offers a comprehensive selection of flashings, barge ends, corner trims and foot moulds. These are manufactured to enhance the appearance and functionality of all Metroll gutter, cladding, roofing and building products.

Metroll offers custom made or standard flashings which are available in a selection of materials to suit your building requirements.

Flashings come in a large range of COLORBOND®, ZINCALUME® and galvanised steels. These come in various widths to a maximum of 1200mm.

CUSTOM MADE FLASHINGS

HOW TO ORDER

1. Choose the appropriate profile number, material thickness and finish.
2. Should COLORBOND® steel be required, nominate which side the colour is to be.
3. Specify the measurement for each letter shown.
4. Specify the angle where applicable.
5. Specify direction for tapered flashings.
6. Specify the quantity and length applicable to each profile.



CORNER MOULD



VALLEY GUTTER



END APRON



PLAIN RIDGE

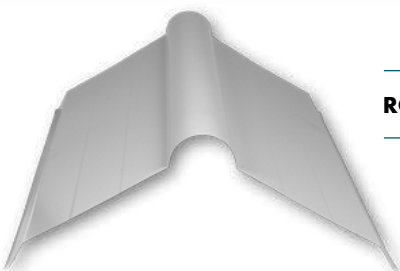

ROLL TOP RIDGE

GUTTERS

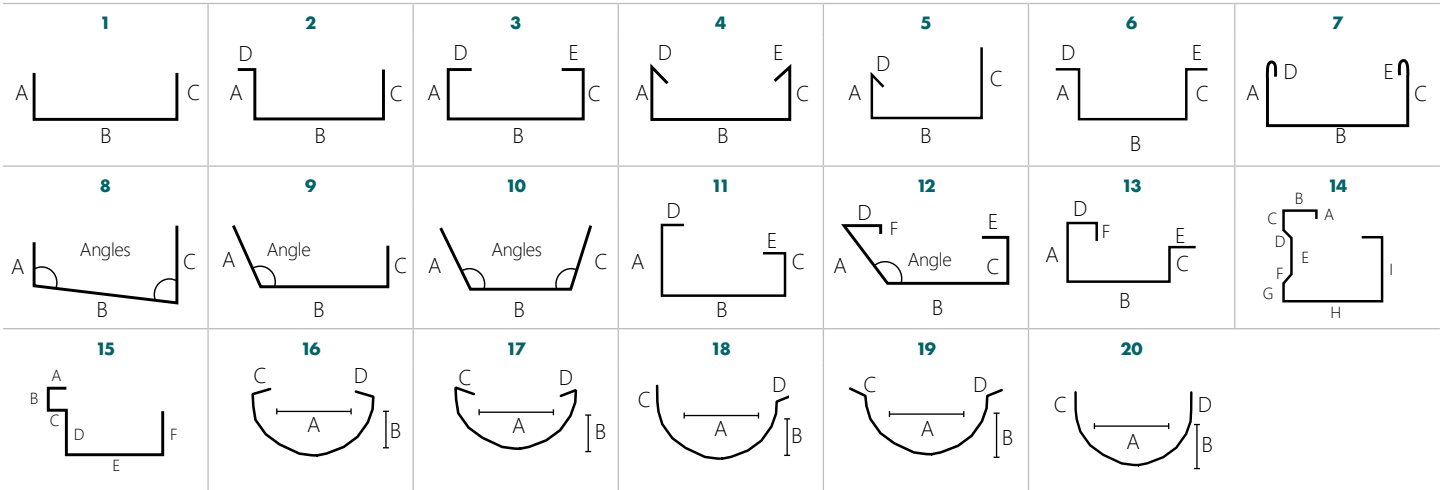

CAPPINGS

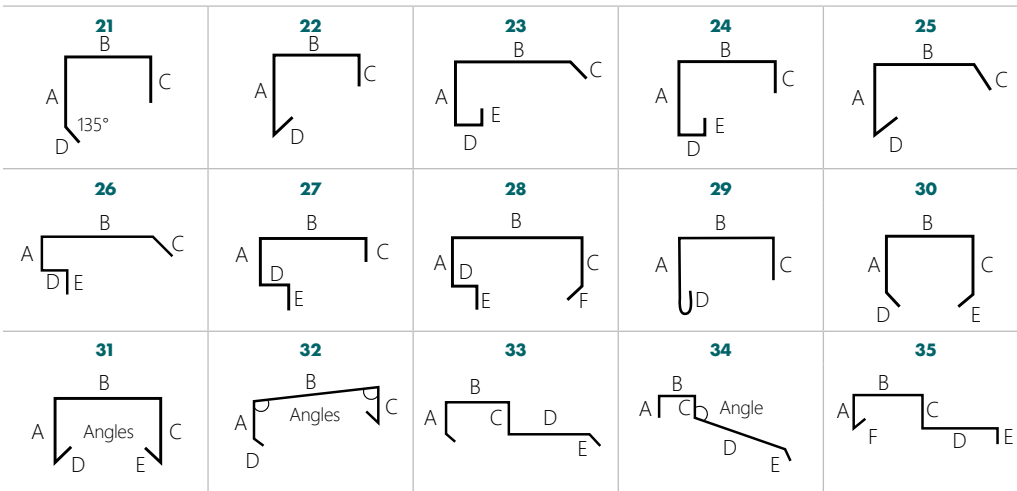

FLASHINGS

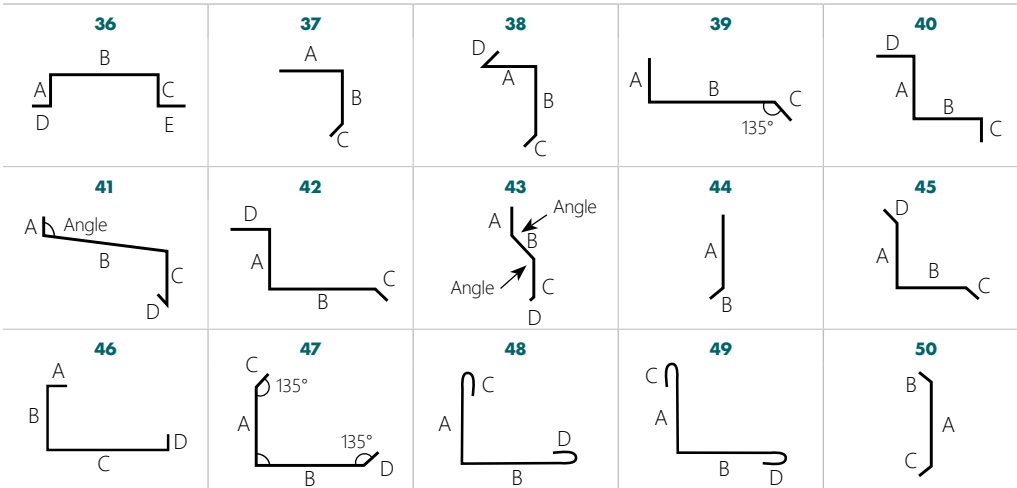

OTHER

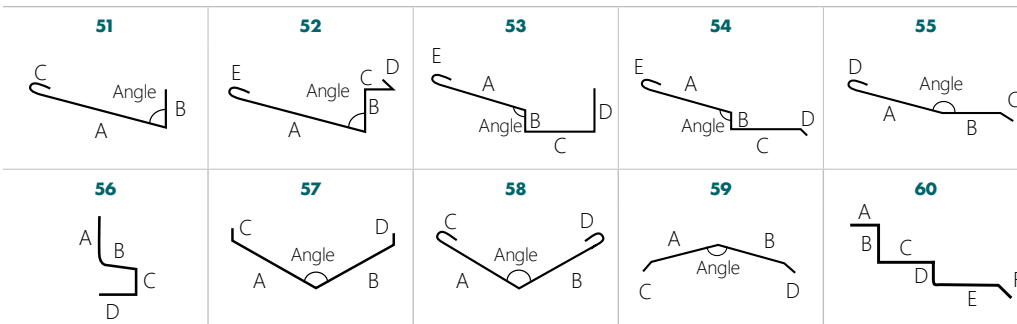

GENERAL INSTALLATION INFO

SAFETY

Always ensure all OH&S regulations have been considered and applied.

Before commencing installation:

1. Ensure support for sheeting is in the same plane.
2. Ensure sheet overhang does not exceed recommendations.
3. Check roof pitch is within minimum recommendation.
4. Ensure the first and last supports together with clips/fasteners are at least 75mm from the end of the sheet for maximum hold.
5. Check set-out is correct as making changes further into installation is very difficult.

SHEET PLACEMENT PRIOR TO INSTALL

Determine prevailing wind and weather direction for maximum weather tightness. Identify downward direction and start install from that end.

Turn sheets on the ground rather than on the roof, this is easier and safer. Before lifting ensure sheets are the correct way up and the overlapping side is facing the edge of the roof where installation will commence. Position sheet bundles over firm supports, not at mid span of roof members.

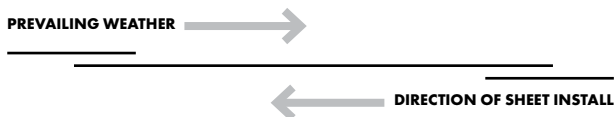

SHEET LAYING

Sheets must be laid in such a manner that the side laps face away from the prevailing winds. A minimum of 50mm must be provided for projection into gutters. Flashings must be provided in compatible materials and their minimum cover must be 150mm.

CLEAN UP

Prior to departing the work site remove all foreign debris, screws, rivets and especially any swarf created by drilling or cutting from the roof surface and/or inside gutters. Failure to do so may result in premature corrosion of the roof or gutters.

CARE, HANDLING & STORAGE

Care should be taken at all times when handling sheets to preserve the quality of the finish. Keep packs dry, stored clear of the ground and protected from rain and moisture. Any sheets which become wet should be separated, wiped and placed in the open air to dry.

CUTTING

Cut sheets with a method and in a location so that damage is avoided to sheets and other building products. Material should be cut on the ground and not above other materials. Remove all swarf and debris from the work and installation area. Sheets may be cut using a power saw with a steel cutting blade, a power nibbler or with tin snips. Avoid using abrasive discs as these can cause edge and coating damage.

WALKING ON SHEETING

When walking on roof sheeting always wear flat rubber soled shoes and only walk over areas where purlins or batten supports are installed.

STOP ENDS & LIPPING

For roof pitches below 15° turn the pans at the top of the sheets up 90° using a turn-up tool to prevent wind driven water entering beneath the flashing. Additionally, turn the pans at the bottom of the sheets down 15° using a turn-down tool to prevent water running along the underside of the sheet.

LENGTH

Metroll supplies roof sheeting and other products cut to order as required depending on load limit regulations set by local transport authorities. Lengths for manufacture need to be site measurements and not taken off plans.

DELIVERY

Ensuring suitable arrangements are made to assist the unloading of Metroll trucks will help supply material in good order. When lifting long lengths by crane please ensure the load is evenly spread. Where a crane cannot be made available it is the customers responsibility to provide sufficient labour to assist the driver in unloading.

MAINTENANCE & CLEANING

Basic maintenance of steel cladding by regular washing with water is recommended. Applications where cladding is naturally washed by rainwater do not usually require this maintenance, e.g. roofing. Areas that are not naturally washed by rainfall, such as eaves, wall cladding and the underside of gutters, will benefit from regular washing. These areas and any others that are not regularly exposed to rainfall should be hosed down every six months. In coastal areas where marine salt is prevalent or areas where high levels of industrial fall-out occur, washing should be carried out more frequently.

If required wash the surface with a mild solution of pure soap or mild non abrasive kitchen detergent in warm water. Apply with a sponge, soft cloth or soft bristle nylon brush. Rinse thoroughly with clean water.

Never use abrasive or solvent based cleaners (turpentine, petrol, kerosene, paint thinner) on COLORBOND® and ZINCALUME® steels.

BLUESCOPE® STEEL WARRANTIES

Visit the BlueScope® Steel website for more information and to apply for a warranty.



QLD		NSW		VIC		SA	
Cairns	07 4054 0888	Lismore	02 6622 6677	Sunshine	03 9480 3744	Adelaide	08 82823300
Townsville	07 4779 8266	Tamworth	02 6765 4799	Laverton	03 8369 8300	NT	
Mackay	07 4968 1255	Newcastle	02 4954 5799	Geelong	03 5248 2006	Darwin	08 8935 9555
Rockhampton	07 4920 0900	Sydney	1300 766 346	Ballarat	03 5335 6416	WA	
Bundaberg	07 4155 5999	Dubbo	02 6883 4800	Pakenham	03 8710 9300	Kalgoorlie	08 9024 1388
Toowoomba	07 4634 6144	Wagga Wagga	02 5924 4500	TAS		Perth	08 9365 5444
Sunshine Coast	07 5493 7872	Canberra	02 6298 2777	Hobart	03 6335 8555	Bunbury	08 9796 9796
Brisbane	07 3375 0100	Albury	02 6043 6800	Launceston	03 6335 8555	Albany	08 9841 6966

29 Metroll Branches Nationwide

Visit our website
metroll.com.au



All reasonable care has been taken in the compilation of the information contained in this brochure. All recommendations on the use of Metroll products are made without guarantee as conditions of use are beyond the control of Metroll. It is the customers responsibility to ensure that the product is fit for its intended purpose and that the actual conditions of use are suitable. Metroll pursues a policy of continuous development and reserves the right to amend specifications without prior notice. The Metroll M and Logo are registered trademarks of Metroll.

COLORBOND®, ZINCALUME®, GALVASPAN®, SUPERDURA® steels are all registered trademarks of BlueScope Steel Limited.

METROLL VEHICLE LOADING GUIDE

The drivers vision **MUST NOT** be obstructed

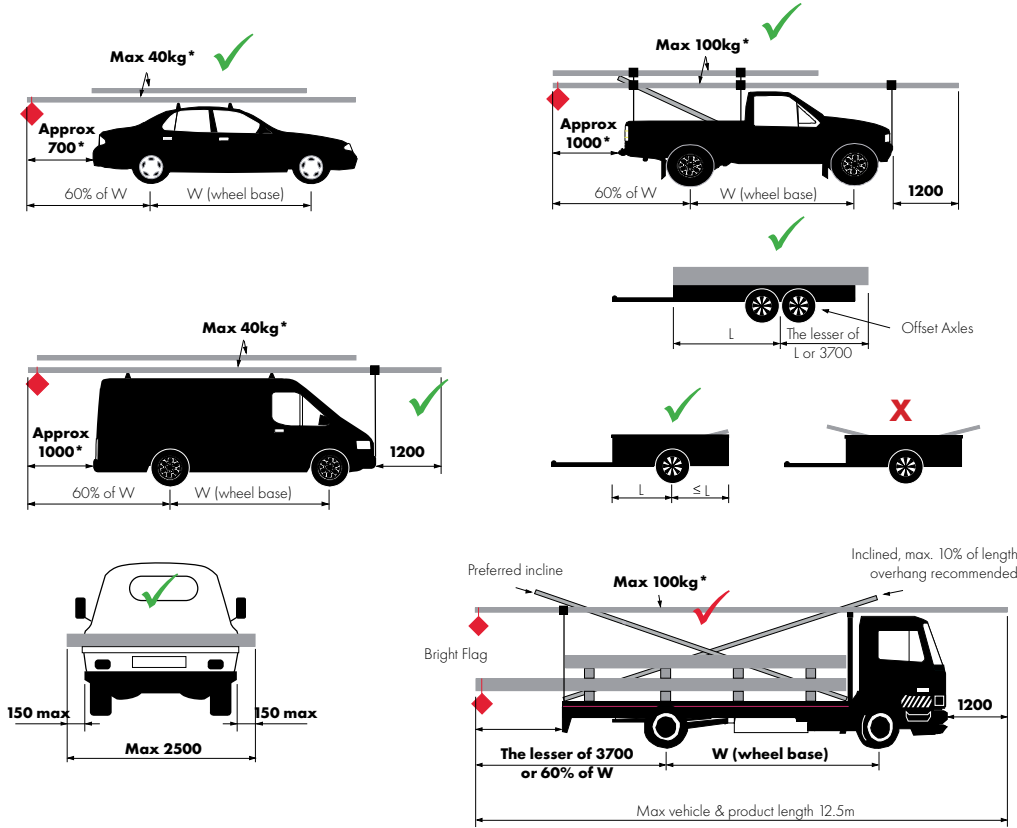

A 300mm square bright flag is required on any overhang that cannot be easily seen and is mandatory over 1200mm.



Secure Your Load

Roof Racks must be secure
Max of 40kg
 Check the Lashing Angle, the more upright = the more secure

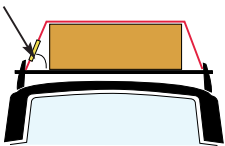

Avoid Low Friction surfaces
 E.g. Steel on Steel,
 Plastic on Plastic,
 Plastic on Steel

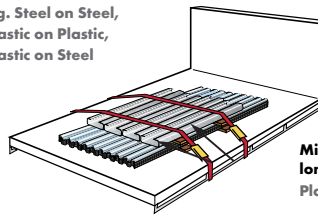

Min. 2 Lashings per stack for items longer than 750mm
 Place wood or rubber between items

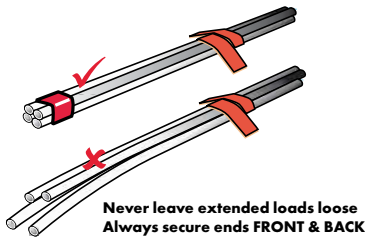

Never leave extended loads loose
Always secure ends FRONT & BACK

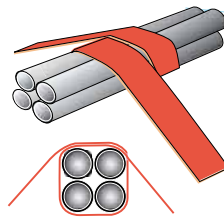

Round & Loose Loads require belly wrapping and extra restraints

Your safety is our concern.
Vehicles considered inappropriate will not be loaded.

This information is a guideline only.
 Compliance with applicable laws and standards remains your responsibility.