

# PRODUCT CATALOGUE.

MOLTO LUCE®

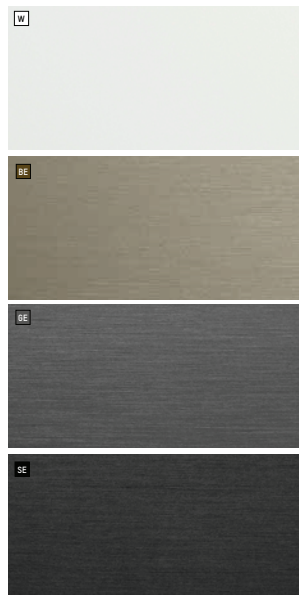

NOV'II



Extra schlanke LED Hängeleuchte mit nur 5mm Breite  
Schwarz, bronze oder graphitgrau eloxiert oder weiß lackiert  
Aus gefrästem Aluminium mit Subminiatur-LEDs  
Satinierter Abdeckung für homogenes Lichtbild  
Abstrahlung mit Direkt- und Indirektanteil 60/40%

Extra slim LED pendant luminaire, 5mm width only  
Black, bronze or graphite grey anodized or white laquered  
Milled aluminium with miniature LEDs  
Gloss cover for homogeneous lighting  
Up and downlight emission 60-40%

Sottilissima sospensione a LED, 5mm di spessore  
Anodizzata in nero, bronzo o grigio grafite o verniciata bianco  
Alluminio fresato con LED  
Diffusore satinato per un'illuminazione omogenea  
Emissione diretta ed indiretta 60-40%

Très mince suspension à LED, 5mm d'épaisseur  
Anodisée en noir, bronze, gris graphite ou vernissée blanc  
Aluminium fraisé avec LED  
Diffuseur satiné pour une homogène illumination  
Émission directe et indirecte 60-40%



IP20

#### AFTER 8 PDI

220-240V AC - CRI >90 - Binning SDCM 3

SYS 41W	lm	W2	lm	W3	lm	W4
601-01041102WXXY	1670	1810	1810			

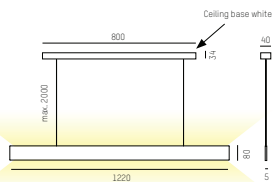

#### AFTER 8 LONG PDI

220-240V AC - CRI >90 - Binning SDCM 3

SYS 51W	lm	W2	lm	W3	lm	W4
601-02051102WXXY	2080	2270	2270			

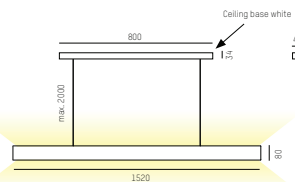

#### ARTIKELNUMMER ERGÄNZEN / COMPLETE CODE

W = LICHTFARBE/LIGHT COLOUR

XX = FARBE/COLOUR

Y = DIMMBAR/DIMMABLE

W2	LED 2700K = 3
W3	LED 3000K = 9
W4	LED 4000K = 4

W	white laquered = 05
SE	black brushed anodized = 41
BE	bronze brushed anodized = 62
BE	graphite grey brushed anodized = 70

A	Analog dimm 1-10V = a
D	DALI dimm = d
Z	ZigBee dimm = z



reddot award 2014 DESIGN PLUS  
winner



German Design Award

WINNER 2015

AFTER 8 PDI

Design: INHOUSE



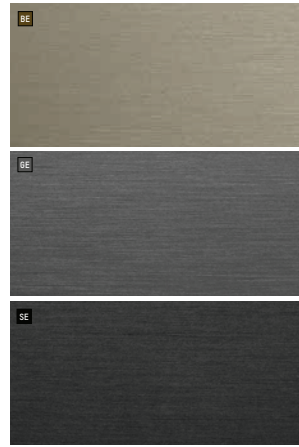

Extra schlanke LED Hängeleuchte mit nur 5mm Breite Oberfläche eloxiert in schwarz, bronze oder graphitgrau Aus gefrästem Aluminium mit Subminiatur-LEDs Satinierte Abdeckung für homogenes Lichtbild Abstrahlung mit Direkt- und Indirektanteil 60/40%

Extra slim LED pendant luminaire, 5mm width only Anodised, black, bronze or graphite grey Milled aluminium with miniature LEDs Gloss cover for homogeneous lighting Up and downlight emission 60-40%

Sottilissima sospensione a LED, 5mm di spessore Superficie anodizzata in nero, bronze o grigio grafite Alluminio fresato con LED Diffusore satinato per un'illuminazione omogenea Emissione diretta ed indiretta 60-40%

Très mince suspension à LED, 5mm d'épaisseur Superficie anodisée en noir, bronze ou gris graphite Aluminium fraisé avec LED Diffuseur satiné pour une homogène illumination Emission directe et indirecte 60-40%

A++ - A

IP20 CE

#### AFTER 8 ROUND PDI

220-240V AC - CRI >90 - Binning SDCM 3

SYS 54W	lm W2	lm W3	lm W4
678-00154102WXXY	2090	2370	2370

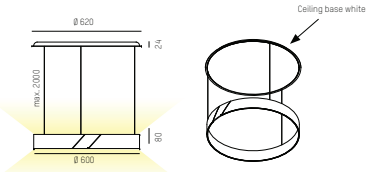

#### ARTIKELNUMMER ERGÄNZEN / COMPLETE CODE

W = LICHTFARBE/LIGHT COLOUR

XX = FARBE/COLOUR

Y = DIMMBAR/DIMMABLE

W2	LED 2700K = 3
W3	LED 3000K = 9
W4	LED 4000K = 4

SE	black brushed anodized = 41
BE	bronze brushed anodized = 62
BE	graphite grey brushed anodized = 70

A	Analog dimm 1-10V = a
D	DALI dimm = d
Z	ZigBee dimm = z



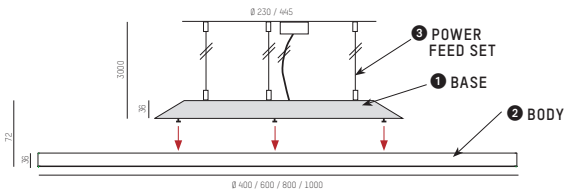

### 1 BETRIEBSBASIS / BASE

Leuchtenkörper und Einspeisungs-Set separat ordern / Order body and power feed set separately

#### BINA PD BASE

for Ø: 400 / 600mm for direct beam  
220-240V AC

663-411010000XXY



#### BINA PD BASE

for Ø: 800 / 1000mm for direct beam  
220-240V AC

663-431010000XXY



#### BINA PDI BASE

for Ø: 400 / 600mm for direct / indirect beam  
220-240V AC - CRI >80 - Binning SDCM 3

SYS 15W

lm W2 lm W3 lm W4

663-41102001WXXY

1365 1415 1415 (lm indirect)



#### BINA PDI BASE

for Ø: 800 / 1000mm for direct / indirect beam  
220-240V AC - CRI >80 - Binning SDCM 3

SYS 26W

lm W2 lm W3 lm W4

663-43102001WXXY

3115 3225 3225 (lm indirect)



### ARTIKELNUMMER ERGÄNZEN / COMPLETE CODE

W = LICHTFARBE/LIGHT COLOUR  
for indirect beam

XX = FARBE/COLOUR BASE

Y = DIMMBAR/DIMMABLE

W2 LED 2700K = 3  
W3 LED 3000K = 9  
W4 LED 4000K = 4

W white = 05  
S black = 06  
SM silver matt = 04

S switchable = 0  
D DALI dimm = d  
E EMERGENCY 3h = e  
E EMERGENCY 3h DALI Dimm = f

Superslanke Hängeleuchte aus Aluminium  
Pulverbeschichtet in weiß, schwarz oder silber matt  
Direktabdeckung in opal oder mikropriamatisch  
Dekoring in weiß, silber matt oder schwarz  
Leuchte besteht aus 3 Teilen

Super-slim suspension in aluminium  
white, black or silver matt powder-coated surface  
Recessed direct cover, opal or microprismatic  
white, silver matt or black decoration ring  
Luminaire consists of 3 parts

Lampada a sospensione a ingombro ridotto in alluminio  
Verniciata a polvere in bianco, nero o grigio opaco  
Copertura retrocessa opale o microprismatica  
Anello decorativo in nero, grigio opaco o bianco  
Lampada composta da 3 parti

Suspension extra-fine in aluminium  
Finition laquée blanc, noir ou gris mat  
Diffuseur en retrait opal ou microprismatique  
Anneau décoratif en noir, gris mat ou blanc  
Luminaire composé de trois éléments

☒ = UGR <19 (not for Ø 400mm)

TUNABLE WHITE auf Anfrage / on request

☒ = PMMA opal diffusor

☒ = Microprismatic diffusor

### 2 LEUCHTENKÖRPER / BODY

Betriebsbasis separat ordern / Order base separately  
CRI >80 - Binning SDCM 3

SYS 29W

Ø: 400mm

lm W2 lm W3 lm W4

663-11100101WXXO

2270 2350 2350

663-11100201WXXO

2275 2355 2355



SYS 58W

Ø: 800mm

lm W2 lm W3 lm W4

663-13100101WXXO

6280 6635 6635

663-13100201WXXO

5775 5980 5980



SYS 38W (PMMA)

SYS 33W (MICROPRISMA)

SYS 76W

Ø: 600mm

lm W2 lm W3 lm W4

663-12100101WXXO

3760 3895 3895

663-12100201WXXO

3365 3485 3485



Ø: 1000mm

lm W2 lm W3 lm W4

663-14100101WXXO

8320 8615 8615

663-14100201WXXO

8345 8640 8640



### ARTIKELNUMMER ERGÄNZEN / COMPLETE CODE

W = LICHTFARBE/LIGHT COLOUR  
for direct beam

XX = FARBE/COLOUR BODY

W2 LED 2700K = 3  
W3 LED 3000K = 9  
W4 LED 4000K = 4

A B  
SM silver matt-silver matt = 44  
SW silver matt-white = 45  
SB silver matt-black = 46  
WS white-silver matt = 54  
WW white-white = 55  
WB white-black = 56  
SBW black-silver matt = 64  
SWB black-white = 65  
SBW black-black = 66



A+ - A

IP 20 CE

## BINA ROUND PD / PDI

Design: INHOUSE



### 3 EINSPEISUNGSSET / POWER FEED SET

Bestehend aus: Baldachin, Kabel 3000mm, 3 x Seil 3000mm, 3 x Deckenbefestigung  
Contents: ceiling base, cable 3000mm, 3 x wire 3000mm, 3 x ceiling fixation

663-206000000XXY

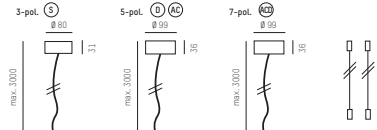

### ARTIKELNUMMER ERGÄNZEN / COMPLETE CODE

XX = FARBE/COLOUR CANOPY

Y = DIMMBAR/DIMMABLE

W white = 05  
S black = 06  
SM silver matt = 04

S switchable = 0  
D DALI dimm = d  
E EMERGENCY 3h DALI Dimm = f



mit Rahmen  
with frame



Rahmenlos  
trimless

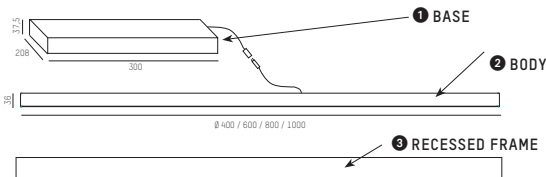

### 1 BETRIEBSBASIS / BASE

Leuchtenkörper separat ordern / Order body separately

#### BINA R BASE

for Ø: 400 / 600mm  
220-240V AC

663-41201000000Y

#### BINA R BASE

for Ø: 800 / 1000mm  
220-240V AC

663-43201000000Y

### ARTIKELNUMMER ERGÄNZEN / COMPLETE CODE

Y = DIMMBAR/DIMMABLE

- Ⓢ switchable = 0      Ⓜ EMERGENCY 3h = e
- Ⓣ DALI dimm = d      Ⓜ EMERGENCY 3h DALI Dimm = f

### 2 LEUCHTENKÖRPER / BODY

Betriebsbasis separat ordern / Order base separately  
CRI >80 - Binning SDCM 3

#### SYS 29W

Ø: 400mm	lm	w2	lm	w3	lm	w4
663-11100101WXX0	2270	2350	2350			
663-11100201WXX0	2275	2355	2355			

#### SYS 58W (PMMA)

Ø: 800mm	lm	w2	lm	w3	lm	w4
663-13100101WXX0	6280	6505	6505			
663-13100201WXX0	5775	5980	5980			

#### SYS 51W (MICROPRISMA)

Ø: 800mm	lm	w2	lm	w3	lm	w4
663-13100101WXX0	6280	6505	6505			
663-13100201WXX0	5775	5980	5980			

#### SYS 38W (PMMA)

Ø: 600mm	lm	w2	lm	w3	lm	w4
663-12100101WXX0	3760	3895	3895			
663-12100201WXX0	3365	3485	3485			

#### SYS 33W (MICROPRISMA)

Ø: 600mm	lm	w2	lm	w3	lm	w4
663-12100101WXX0	3760	3895	3895			
663-12100201WXX0	3365	3485	3485			

#### SYS 76W

Ø: 1000mm	lm	w2	lm	w3	lm	w4
663-14100101WXX0	8320	8615	8615			
663-14100201WXX0	8345	8640	8640			

### ARTIKELNUMMER ERGÄNZEN / COMPLETE CODE

W = LICHTFARBE/LIGHT COLOUR

w2	LED 2700K = 3
w3	LED 3000K = 9
w4	LED 4000K = 4

XX = FARBE/COLOUR BODY

A	B	Color
SM	SM	silver matt-silver matt = 44
SM	W	silver matt-white = 45
SM	S	silver matt-black = 46
W	SM	white-silver matt = 54
W	W	white-white = 55
W	S	white-black = 56
S	SM	black-silver matt = 64
S	W	black-white = 65
S	S	black-black = 66



Superschlange Einbauleuchte aus Aluminium  
Pulverbeschichtet in weiß, schwarz oder silber matt  
Direktabdeckung in opal oder mikropriamatisch  
Dekoring in weiß, silber matt oder schwarz  
Leuchte besteht aus 3 Teilen

Super-slim recessed luminaire in aluminium  
white, black or silver matt powder-coated surface  
Recessed direct cover, opal or microprismatic  
white, silver matt or black decoration ring  
Luminaire consists of 3 parts

Lampada ad incasso a ingombro ridotto in alluminio  
Verniciata a polvere in bianco, nero o grigio opaco  
Copertura retrocessa opale o microprismatica  
Anello decorativo in nero, grigio opaco o bianco  
Lampada composta da 3 parti

Encastré extra-fin en aluminium  
Finition laquée blanc, noir ou gris mat  
Diffuseur en retrait opal ou microprismatique  
Anneau décoratif en noir, gris mat ou blanc  
Luminaire composé de trois éléments

UGR <19 (not for Ø 400mm)

TUNABLE WHITE auf Anfrage / on request

PMMA opal diffusor

Microprismatic diffusor

A\*\* - A

IP 20 CE



### 3 EINBAURAHMEN / RECESSED FRAME



663-113000000XX0	DA: Ø 408 for Ø 400mm
663-123000000XX0	DA: Ø 608 for Ø 600mm
663-133000000XX0	DA: Ø 808 for Ø 800mm
663-143000000XX0	DA: Ø 1008 for Ø 1000mm

### 3 EINBAURAHMEN TRIMLESS RECESSED FRAME TRIMLESS



663-114000000050	W	DA: Ø 408 for Ø 400mm
663-124000000050	W	DA: Ø 608 for Ø 600mm
663-134000000050	W	DA: Ø 808 for Ø 800mm
663-144000000050	W	DA: Ø 1008 for Ø 1000mm

### ARTIKELNUMMER ERGÄNZEN / COMPLETE CODE

XX = FARBE/COLOUR FRAME

SM	silver matt = 04
W	white = 05
S	black = 06

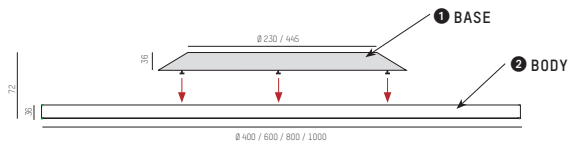

### 1 BETRIEBSBASIS / BASE

Leuchtenkörper separat ordern / Order body separately

#### BINA SD BASE

for Ø: 400 / 600mm for direct beam  
220-240V AC

663-411010000XXY

#### BINA SD BASE

for Ø: 800 / 1000mm for direct beam  
220-240V AC

663-431010000XXY

#### BINA SDI BASE

for Ø: 400 / 600mm for direct / indirect beam  
220-240V AC - CRI >80 - Binning SDCM 3

SYS 15W

lm	W2	W3	W4
1365	1415	1415	(lm indirect)

663-41102001WXXY

#### BINA SDI BASE

for Ø: 800 / 1000mm for direct / indirect beam  
220-240V AC - CRI >80 - Binning SDCM 3

SYS 26W

lm	W2	W3	W4
3115	3225	3225	(lm indirect)

663-43102001WXXY

### ARTIKELNUMMER ERGÄNZEN / COMPLETE CODE

W = LICHTFARBE/LIGHT COLOUR  
for indirect beam

XX = FARBE/COLOUR BASE

Y = DIMMBAR/DIMMABLE

W2	LED 2700K = 3
W3	LED 3000K = 9
W4	LED 4000K = 4

W	white = 05
S	black = 06
SM	silver matt = 04

S	switchable = 0
D	DALI dimm = d
AC	EMERGENCY 3h = e
CE	EMERGENCY 3h DALI Dimm = f

Superschlanke Aufbauleuchte aus Aluminium  
Pulverbeschichtet in weiß, schwarz oder silber matt  
Direktabdeckung in opal oder mikroprismatisch  
Dekoring in weiß, silber matt oder schwarz  
Leuchte besteht aus 2 Teilen

Super-slim surface mounted luminaire in aluminium  
white, black or silver matt powder-coated surface  
Recessed direct cover, opal or microprismatic  
white, silver matt or black decoration ring  
Luminaire consists of 2 parts

Lampada da soffitto a ingombro ridotto in alluminio  
Verniciata a polvere in bianco, nero o grigio opaco  
Copertura retrocessa opale o microprismatica  
Anello decorativo in nero, grigio opaco o bianco  
Lampada composta da 2 parti

Applique extra-fine en aluminium  
Finition laquée blanc, noir ou gris mat  
Diffuseur en retrait opal ou microprismatique  
Anneau décoratif en noir, gris mat ou blanc  
Luminaire composé de deux éléments

☐ = UGR <19 (not for Ø 400mm)

TUNABLE WHITE auf Anfrage / on request

☐ = PMMA opal diffusor

☐ = Microprismatic diffusor

A++ - A

IP 20 CE

### 2 LEUCHTENKÖRPER / BODY

Betriebsbasis separat ordern / Order base separately  
CRI >80 - Binning SDCM 3

SYS 29W

Ø: 400mm	lm	W2	W3	W4
663-11100101WXXO	2270	2350	2350	
663-11100201WXXO	2275	2355	2355	

☐ = ☐

SYS 58W (PMMA)

Ø: 800mm	lm	W2	W3	W4
663-13100101WXXO	6280	6505	6505	
663-13100201WXXO	5775	5980	5980	

☐ = ☐

SYS 51W (MICROPRISMA)

Ø: 800mm	lm	W2	W3	W4
663-13100101WXXO	6280	6505	6505	
663-13100201WXXO	5775	5980	5980	

☐ = ☐

SYS 38W (PMMA)

Ø: 600mm	lm	W2	W3	W4
663-12100101WXXO	3760	3895	3895	
663-12100201WXXO	3365	3485	3485	

☐ = ☐

SYS 33W (MICROPRISMA)

Ø: 600mm	lm	W2	W3	W4
663-12100101WXXO	3760	3895	3895	
663-12100201WXXO	3365	3485	3485	

☐ = ☐

SYS 76W

Ø: 1000mm	lm	W2	W3	W4
663-14100101WXXO	8320	8615	8615	
663-14100201WXXO	8345	8640	8640	

☐ = ☐

### ARTIKELNUMMER ERGÄNZEN / COMPLETE CODE

W = LICHTFARBE/LIGHT COLOUR  
for direct beam

XX = FARBE/COLOUR BODY

W2	LED 2700K = 3
W3	LED 3000K = 9
W4	LED 4000K = 4

A	B	silver matt-silver matt = 44
SM	W	silver matt-white = 45
SM	S	silver matt-black = 46
W	SM	white-silver matt = 54
W	W	white-white = 55
W	S	white-black = 56
S	SM	black-silver matt = 64
S	W	black-white = 65
S	S	black-black = 66



## BINA ROUND SD / SDI

Design: INHOUSE



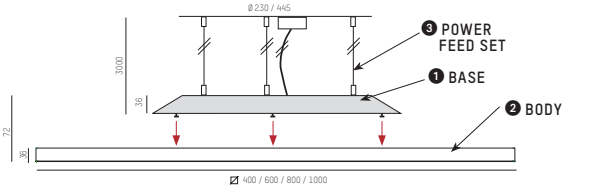
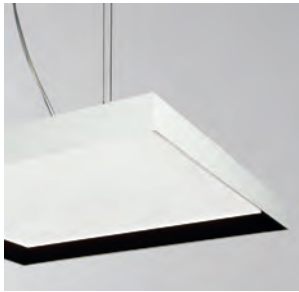

**1 BETRIEBSBASIS / BASE**  
Leuchtenkörper separat ordern / Order body separately

**BINA PD BASE**  
for  $\square$ : 400x400 / 600x600mm for direct beam  
220-240V AC

663-411010000XXY

**BINA PD BASE**  
for  $\square$ : 800x800 / 1000x1000mm for direct beam  
220-240V AC

663-431010000XXY

**BINA PDI BASE**  
for  $\square$ : 400x400 / 600x600mm for direct-indirect beam  
220-240V AC - CRI >80 - Binning SDCM 3

SYS 15W

	lm	w2	lm	w3	lm	w4
663-41102001WXXY	1365	1415	1415			

**BINA PDI BASE**  
for  $\square$ : 800x800 / 1000x1000mm for direct-indirect beam  
220-240V AC - CRI >80 - Binning SDCM 3

SYS 26W

	lm	w2	lm	w3	lm	w4
663-43102001WXXY	3115	3225	3225			

**ARTIKELNUMMER ERGÄNZEN / COMPLETE CODE**

**W** = LICHTFARBE/LIGHT COLOUR for indirect beam  
**XX** = FARBE/COLOUR BASE  
**Y** = DIMMBAR/DIMMABLE

**W** LED 2700K = 3  
**W3** LED 3000K = 9  
**W4** LED 4000K = 4

**W** white = 05  
**S** black = 06  
**SM** silver matt = 04

**S** switchable = 0  
**D** DALI dimm = d  
**EM** EMERGENCY 3h = e  
**EMD** EMERGENCY 3h DALI Dimm = f

Superschlankes Hängeleuchte aus Aluminium  
Pulverbeschichtet in weiß, schwarz oder silber matt  
Direktabdeckung in opal oder mikropriamatisch  
Dekoring in weiß, silber matt oder schwarz  
Leuchte besteht aus 3 Teilen

Super-slim suspension in aluminium  
white, black or silver matt powder-coated surface  
Recessed direct cover, opal or microprismatic  
white, silver matt or black decoration ring  
Luminaire consists of 3 parts

Lampada a sospensione a ingombro ridotto in alluminio  
Verniciata a polvere in bianco, nero o grigio opaco  
Copertura retroscassa opale o microprismatica  
Anello decorativo in nero, grigio opaco o bianco  
Lampada composta da 3 parti

Suspension extra-fine in aluminium  
Finition laquée blanc, noir ou gris mat  
Diffuseur en retrait opal ou microprismatique  
Anneau décoratif en noir, gris mat ou blanc  
Luminaire composé de trois éléments

= UGR<19 (not for  $\square$  400mm)  
TUNABLE WHITE auf Anfrage / on request  
 = PMMA opal diffusor  
 = Microprismatic diffusor

**A++** - **A**  
IP20

**2 LEUCHTENKÖRPER / BODY**

Betriebsbasis separat ordern / Order base separately  
CRI >80 - Binning SDCM 3

SYS 29W

$\square$ : 400x400mm

	lm	w2	lm	w3	lm	w4
663-21100101WXX0	2680	2775	2775			
663-21100201WXX0	2685	2780	2780			

SYS 58W

$\square$ : 800x800mm

	lm	w2	lm	w3	lm	w4
663-23100101WXX0	6410	6635	6635			
663-23100201WXX0	6315	6540	6540			

SYS 38W (PMMA)    SYS 33W (MICROPRISMA)    SYS 76W

$\square$ : 600x600mm

	lm	w2	lm	w3	lm	w4
663-22100101WXX0	3745	3875	3875			
663-22100201WXX0	3390	3510	3510			

$\square$ : 1000x1000mm

	lm	w2	lm	w3	lm	w4
663-24100101WXX0	8530	8835	8835			
663-24100201WXX0	8430	8730	8730			

**ARTIKELNUMMER ERGÄNZEN / COMPLETE CODE**

**W** = LICHTFARBE/LIGHT COLOUR for direct beam  
**XX** = FARBE/COLOUR BODY

**W** LED 2700K = 3  
**W3** LED 3000K = 9  
**W4** LED 4000K = 4

**A** **B**  
**SM** **SM** silver matt-silver matt = 44  
**SM** **W** silver matt-white = 45  
**SM** **S** silver matt-black = 46  
**SM** **SM** white-silver matt = 54  
**W** **W** white-white = 55  
**W** **S** white-black = 56  
**S** **SM** black-silver matt = 64  
**S** **W** black-white = 65  
**S** **S** black-black = 66

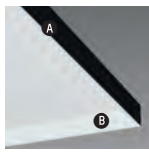

**3 EINSPEISUNGSSET / POWER FEED SET**

Bestehend aus: Baldachin, Kabel 3000mm, 3 x Seil 3000mm, 3 x Deckenbefestigung  
Contents: ceiling base, cable 3000mm, 3 x wire 3000mm, 3 x ceiling fixation

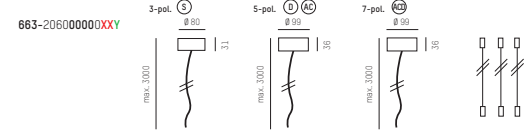

**ARTIKELNUMMER ERGÄNZEN / COMPLETE CODE**

**XX** = FARBE/COLOUR CANOPY    **Y** = DIMMBAR/DIMMABLE

**W** white = 05  
**S** black = 06  
**SM** silver matt = 04

**S** switchable = 0  
**D** DALI dimm = d  
**EM** EMERGENCY 3h DALI Dimm = f

118 **BINA SQUARE PD / PDI**  
Design: INHOUSE



mit Rahmen  
with frame



Rahmenlos  
trimless

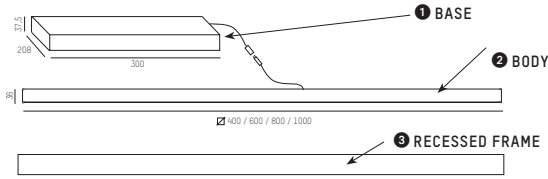

### 1 BETRIEBSBASIS / BASE

Leuchtenkörper separat ordern / Order body separately

#### BINA R BASE

for  $\square$ : 400x400 / 600x600mm  
220-240V AC/DC

663-41201000000Y

#### BINA R BASE

for  $\square$ : 800x800 / 1000x1000mm  
220-240V AC/DC

663-43201000000Y

### ARTIKELNUMMER ERGÄNZEN / COMPLETE CODE

Y = DIMMBAR/DIMMABLE

- ③ switchable = 0
- ④ DALI dimm = d
- Ⓜ EMERGENCY 3h = e
- Ⓜ EMERGENCY 3h DALI Dimm = f

### 2 LEUCHTENKÖRPER / BODY

Betriebsbasis separat ordern / Order base separately  
CRI >80 - Binning SDCM 3

#### SYS 29W

$\square$ : 400x400mm

	lm	w2	lm	w3	lm	w4
663-21100101WXX0	2680	2775	2775			
663-21100201WXX0	2685	2780	2780			

#### SYS 58W

$\square$ : 800x800mm

	lm	w2	lm	w3	lm	w4
663-23100101WXX0	6410	6635	6635			
663-23100201WXX0	6315	6540	6540			

#### SYS 38W (PMMA)

$\square$ : 600x600mm

	lm	w2	lm	w3	lm	w4
663-22100101WXX0	3745	3875	3875			
663-22100201WXX0	3390	3510	3510			

#### SYS 33W (MICROPRISMA)

$\square$ : 600x600mm

	lm	w2	lm	w3	lm	w4
663-22100101WXX0	3745	3875	3875			
663-22100201WXX0	3390	3510	3510			

#### SYS 76W

$\square$ : 1000x1000mm

	lm	w2	lm	w3	lm	w4
663-24100101WXX0	8530	8835	8835			
663-24100201WXX0	8430	8730	8730			

### ARTIKELNUMMER ERGÄNZEN / COMPLETE CODE

W = LICHTFARBE/LIGHT COLOUR

w2	LED 2700K = 3
w3	LED 3000K = 9
w4	LED 4000K = 4

XX = FARBE/COLOUR BODY

A	SM	SM	silver matt-silver matt = 44
A	SM	W	silver matt-white = 45
A	SM	S	silver matt-black = 46
W	SM	SM	white-silver matt = 54
W	SM	W	white-white = 55
W	SM	S	white-black = 56
S	SM	SM	black-silver matt = 64
S	SM	W	black-white = 65
S	SM	S	black-black = 66

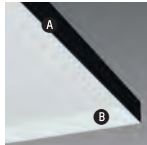

Superschlange Einbauleuchte aus Aluminium  
Pulverbeschichtet in weiß, schwarz oder silber matt  
Direktabdeckung in opal oder mikrop Prismatisch  
Dekoring in weiß, silber matt oder schwarz  
Leuchte besteht aus 3 Teilen

Super-slim recessed luminaire in aluminium  
white, black or silver matt powder-coated surface  
Recessed direct cover, opal or microprismatic  
white, silver matt or black decoration ring  
Luminaire consists of 3 parts

Lampada ad incasso a ingombro ridotto in alluminio  
Verniciata a polvere in bianco, nero o grigio opaco  
Copertura retrocessa opale o microprismatica  
Anello decorativo in nero, grigio opaco o bianco  
Lampada composta da 3 parti

Encastré extra-fin en aluminium  
Finition laquée blanc, noir ou gris mat  
Diffuseur en retrait opal ou microprismatique  
Anneau décoratif en noir, gris mat ou blanc  
Luminaire composé de trois éléments

UGR < 19 (not for  $\square$  400mm)

TUNABLE WHITE auf Anfrage / on request

PMMA opal diffusor

Microprismatic diffusor

A\*\* - A

IP 20 CE



Visualisation: nonstandard.at

### 3 EINBAURAHMEN / RECESSED FRAME

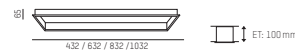

663-213000000XX0	DA:	$\square$ 408 for $\square$ 400mm
663-223000000XX0	DA:	$\square$ 608 for $\square$ 600mm
663-233000000XX0	DA:	$\square$ 808 for $\square$ 800mm
663-243000000XX0	DA:	$\square$ 1008 for $\square$ 1000mm

### 3 EINBAURAHMEN TRIMLESS RECESSED FRAME TRIMLESS

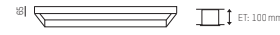

663-214000000050	W	DA:	$\square$ 408 for $\square$ 400mm
663-224000000050	W	DA:	$\square$ 608 for $\square$ 600mm
663-234000000050	W	DA:	$\square$ 808 for $\square$ 800mm
663-244000000050	W	DA:	$\square$ 1008 for $\square$ 1000mm

### ARTIKELNUMMER ERGÄNZEN / COMPLETE CODE

XX = FARBE/COLOUR FRAME

SM	silver matt = 04
W	white = 05
S	black = 06



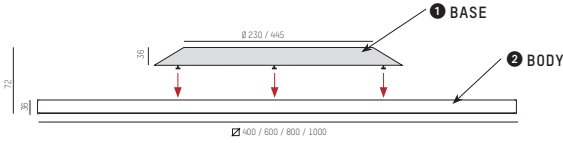
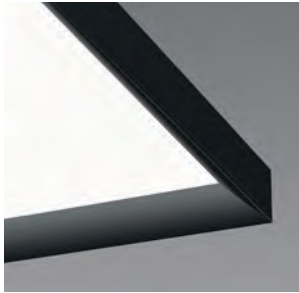

### 1 BETRIEBSBASIS / BASE

Leuchtenkörper separat ordern / Order body separately

#### BINA SD BASE

for  $\square$ : 400x400 / 600x600mm for direct beam  
220-240V AC

663-411010000XXY

#### BINA SDI BASE

for  $\square$ : 800x800 / 1000x1000mm for direct beam  
220-240V AC

663-431010000XXY

#### BINA SDI BASE

for  $\square$ : 400x400 / 600x600mm for direct-indirect beam  
220-240V AC - CRI >80 - Binning SDCM 3

SYS 15W

lm	W2	lm	W3	lm	W4
663-41102001WXXY	1365	1415	1415	(lm indirect)	

#### BINA SDI BASE

for  $\square$ : 800x800 / 1000x1000mm for direct-indirect beam  
220-240V AC - CRI >80 - Binning SDCM 3

SYS 26W

lm	W2	lm	W3	lm	W4
663-43102001WXXY	3115	3225	3225	(lm indirect)	

### ARTIKELNUMMER ERGÄNZEN / COMPLETE CODE

**W** = LICHTFARBE/LIGHT COLOUR  
for indirect beam

W2	LED 2700K = 3
W3	LED 3000K = 9
W4	LED 4000K = 4

**XX** = FARBE/COLOUR BASE

W	white = 05
S	black = 06
SM	silver matt = 04

**Y** = DIMMBAR/DIMMABLE

S	switchable = 0
D	DALI dimm = d
AE	EMERGENCY 3h = e
AE	EMERGENCY 3h DALI Dimm = f

Superschlankes Aufbauleuchte aus Aluminium  
Pulverbeschichtet in weiß, schwarz oder silber matt  
Direktabdeckung in opal oder mikropismatisch  
Dekoring in weiß, silber matt oder schwarz  
Leuchte besteht aus 2 Teilen

Super-slim surface mounted luminaire in aluminium  
white, black or silver matt powder-coated surface  
Recessed direct cover, opal or micropismatic  
white, silver matt or black decoration ring  
Luminaire consists of 2 parts

Lampada da soffitto a ingombro ridotto in alluminio  
Verniciata a polvere in bianco, nero o grigio opaco  
Copertura retrocessa opale o micropismatica  
Anello decorativo in nero, grigio opaco o bianco  
Lampada composta da 2 parti

Applique extra-fine en aluminium  
Finition laquée blanc, noir ou gris mat  
Diffuseur en retrait opal ou micropismatique  
Anneau décoratif en noir, gris mat ou blanc  
Luminaire composé de deux éléments

= UGR<19 (not for  $\square$  400mm)

TUNABLE WHITE auf Anfrage / on request

= PMMA opal diffusor

= Microprismatic diffusor

A\*\* - A

IP 20

### 2 LEUCHTENKÖRPER / BODY

Betriebsbasis separat ordern / Order base separately  
CRI >80 - Binning SDCM 3

SYS 29W

$\square$ : 400x400mm	lm	W2	lm	W3	lm	W4
663-21100101WXXO	2680	2775	2775			
663-21100201WXXO	2685	2780	2780			

SYS 58W

$\square$ : 800x800mm	lm	W2	lm	W3	lm	W4
663-23100101WXXO	6410	6635	6635			
663-23100201WXXO	6315	6540	6540			

SYS 38W (PMMA)

$\square$ : 600x600mm	lm	W2	lm	W3	lm	W4
663-22100101WXXO	3745	3875	3875			
663-22100201WXXO	3390	3510	3510			

SYS 33W (MICROPRISMA)

SYS 76W

$\square$ : 1000x1000mm	lm	W2	lm	W3	lm	W4
663-24100101WXXO	8530	8835	8835			
663-24100201WXXO	8430	8730	8730			

### ARTIKELNUMMER ERGÄNZEN / COMPLETE CODE

**W** = LICHTFARBE/LIGHT COLOUR  
for direct beam

W2	LED 2700K = 3
W3	LED 3000K = 9
W4	LED 4000K = 4

**XX** = FARBE/COLOUR BODY

A	B	SM	SM	silver matt-silver matt = 44
SM	W	SM	W	silver matt-white = 45
SM	S	SM	S	silver matt-black = 46
W	SM	SM	SM	white-silver matt = 54
W	W	SM	W	white-white = 55
W	S	SM	S	white-black = 56
S	SM	SM	SM	black-silver matt = 64
S	W	SM	W	black-white = 65
S	S	SM	S	black-black = 66

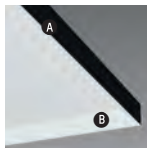



BLINDSPOT rahmenlos mit Einbauring  
BLINDSPOT frameless with mounting ring



BLINDSPOT mit Einbaurahmen  
BLINDSPOT with recessing frame

Rahmenloser LED Einbauspot aus Aluminium  
Oberfläche in weiß oder schwarz  
Zurückversetzte Linsen mit verschiedenen Abstrahlwinkeln  
Lichtaustrittsfläche von nur 10 mm  
Perfekte Entblendung und erhöhter Sehkomfort

Frameless recessed LED spotlight in aluminium  
White or black finish  
Recessed lenses with different beam-angles  
light exit field with only 10 mm  
Perfect glare control and increased visual comfort

Incastro LED a scomparsa in alluminio  
Finitura in bianco o nero  
Lenti spostati indietro con varie emissioni  
Dispositivo di eliminazione di soli 10 mm  
Controllo anti-abbagliamento per un elevato comfort visivo

Encastré LED sans cadre en aluminium  
Vernissage blanc ou noir  
Lentilles déplacés au fond avec d'émissions différentes  
Plus que 10mm de surface d'émission de lumière  
Contrôle anti-éblouissement et confort visuel optimal

UGR < 16

LED 2700K  
LED 3000K

A++ A

IP20

LFO Lens-Technology by Bartenbach



#### BLINDSPOT MIT EINBAURAHMEN

LED 9W - 700mA, CR x30 - Strömung 300mA 3  
Einbauring, Einbaurahmen und Werkzeug separat ordern / order mounting ring, recessing frame and tool separately  
exkl. LED Konverter (separat ordern) / excl. LED converter (order separately)

640-0010101233XX	max. 32mm	400mm
640-0010101293XX	68 mm, ET 100mm	430mm
640-0010103233XX	172° +/- 30°	400mm
640-0010103293XX		430mm



#### EINBAURING / MOUNTING RING

640-000010

640-000020 Werkzeug zu Einbauring / Tool for mounting ring



#### EINBAURAHMEN / RECESSING FRAME

640-000035  
640-000036



#### LED-KONVERTER / LED CONVERTER

- 24-122441 11W / 700mA, not dimmable
- 24-123403 20W / 700mA, DALI dimm.

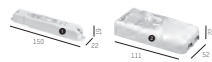

ACHTUNG!!!!  
Ergänzen Sie das XX der Art. Nr. mit Ihrer gewünschten Farbe

ATTENTION!!!!  
Complete the XX of the code with your favourite colour

weiß / white = 55  
schwarz / black = 66

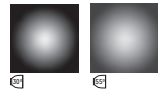

Originalphoto by W-K-Fotografie Wels, www.wkphoto.net



BLINDSPOT rahmenlos mit Einbauring flächenbündig  
BLINDSPOT frameless with mounting ring flush mounted

BLINDSPOT rahmenlos mit Einbauring und Schattenfuge  
BLINDSPOT frameless with mounting ring and shadow gap

Rahmenloser LED Einbauspot aus Aluminium  
Oberfläche: Mineralfaserplatte natur, überstreichbar  
Zurückversetzte Linsen mit verschiedenen Abstrahlwinkeln  
Lichtaustrittsfläche von nur 10 mm  
Perfekte Entblendung und erhöhter Sehkomfort

Frameless recessed LED spotlight in aluminium  
Surface: mineral fiber board nature, paintable  
Recessed lenses with different beam-angles  
light exit field with only 10 mm  
Perfect glare control and increased visual comfort

Incastro LED a scomparsa in alluminio  
Superficie in fibra naturale tinteggiabile  
Lenti spostati indietro con varie emissioni  
Dispositivo di illuminazione di soli 10 mm  
Controllo anti-abbagliamento per un elevato comfort visivo

Encastré LED sans cadre en aluminium  
Surface en peinture fibre naturelle  
Lentilles déplacés au fond avec d'émissions différentes  
Plus que 10 mm de surface d'émission de lumière  
Contrôle anti-éblouissement et confort visuel optimal

UGR < 16

LED 2700K  
LED 3000K

A+ A

IP 20

LF0 Lens-Technology by Bartenbach

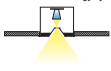

#### BLINDSPOT FRAMELESS

LED 9W / 700mA, CRI >90 - dimming SDGM 3  
Einbauring und Werkzeug separat ordern / order mounting ring and tool separately  
exkl. LED Konverter (separat ordern) / excl. LED converter (order separately)

640-00201012300	LED	9W	400mm
640-00201012900	LED	9W	430mm
640-00201032300	LED	9W	400mm
640-00201032900	LED	9W	430mm



#### EINBAURING / MOUNTING RING

640-000010

640-000020 Werkzeug zu Einbauring / Tool for mounting ring



#### LED-KONVERTER / LED CONVERTER

- 24-122441 11W / 700mA, not dimmable
- 24-123403 20W / 700mA, DALI dimm.

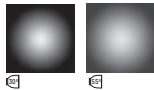

Originalphoto by W-K-Fotografie Wels, www.wkphoto.net



CHARM weiß + Dekorfolie schwarz  
CHARM white + decor foil black

Smooth Design Ringleuchte aus Aluminium  
in weiß matt bzw. schwarz matt pulverbeschichtet  
direkt oder direkt indirekt strahlend  
Konverter im Leuchtenprofil integriert  
Dekor-Einschubfolien zur individuellen Gestaltung

Ring luminaire with smooth design in aluminium  
White matt or black matt powder-coated  
direct and indirect beam  
Built-in converter in profile  
Decoration slide-film for individual design

Lampada a forma di anello in alluminio  
Verniciata a polvere in bianco opaco o nero opaco  
Luce diretta ed indiretta  
Convertitore incluso nel profilo  
Pellicola decorativa per customizzazione

Suspension en forme d'anneau, en aluminium  
Finition laquée blanc mat ou noir mat  
Émission directe et indirecte  
Convertisseur intégré dans le profil  
Film décoratif pour personnalisation



reddot award 2018  
winner

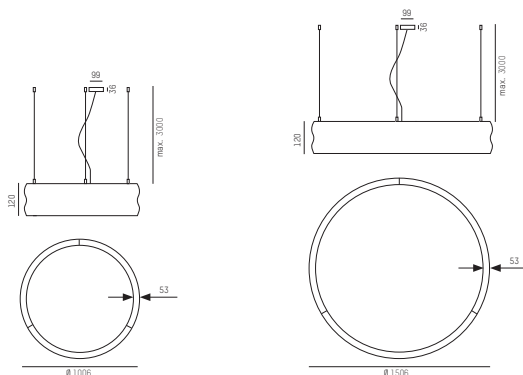

#### CHARM 1000 PD

220-240V AC - CRI >90 - Binning SDCM 3

SYS 91W - Ø: 1006mm

	lm	W2	lm	W3	lm	W4
671-20101102W05Y	5320	5780	6010			
671-20101102W06Y	3690	4010	4170			

#### CHARM 1500 PD

220-240V AC - CRI >90 - Binning SDCM 3

SYS 137W - Ø: 1506mm

	lm	W2	lm	W3	lm	W4
671-20201102W05Y	7970	8660	9000			
671-20201102W06Y	5530	6010	6250			

#### CHARM 1000 PDI

220-240V AC - CRI >90 - Binning SDCM 3

SYS 151W - Ø: 1006mm

	lm	W2	lm	W3	lm	W4
671-20102102W05Y	11180	12150	12640			
671-20102102W06Y	9550	10390	10800			

#### CHARM 1500 PDI

220-240V AC - CRI >90 - Binning SDCM 3

SYS 235W - Ø: 1506mm

	lm	W2	lm	W3	lm	W4
671-20202102W05Y	17480	19000	19760			
671-20202102W06Y	15040	16350	17000			

#### ARTIKELNUMMER ERGÄNZEN / COMPLETE CODE

W = LICHTFARBE/LIGHT COLOUR

Y = DIMMBAR/DIMMABLE

W2	LED 2700K = 3
W3	LED 3000K = 9
W4	LED 4000K = 4

Y	switchable = 0
Y	DALI dimm = d

#### CHARM 1000 DEKORFOLIEN / DECOR FOIL

3 Sets je Ring ordern / Order 3 pieces every ring  
zum Einschleiben in das Profil / to insert into the profile  
separat ordern / order separately

671-430000000050	W	LUMEN - 0%
671-430000000060	S	LUMEN - 40%
671-430000000130	R	LUMEN - 27%
671-430000000430	KU	LUMEN - 25%

#### CHARM 1500 DEKORFOLIEN / DECOR FOIL

3 Sets je Ring ordern / Order 3 pieces every ring  
zum Einschleiben in das Profil / to insert into the profile  
separat ordern / order separately

671-431000000050	W	LUMEN - 0%
671-431000000060	S	LUMEN - 40%
671-431000000130	R	LUMEN - 27%
671-431000000430	KU	LUMEN - 25%



CHARM SYSTEM PD/PDI: Look at MOLTO LUCE 2019/20 main Catalogue



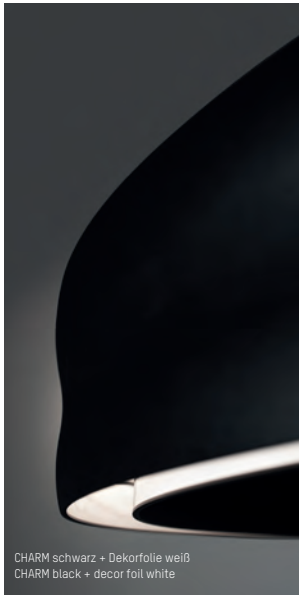

CHARM schwarz + Dekorfolie weiß  
CHARM black + decor foil white

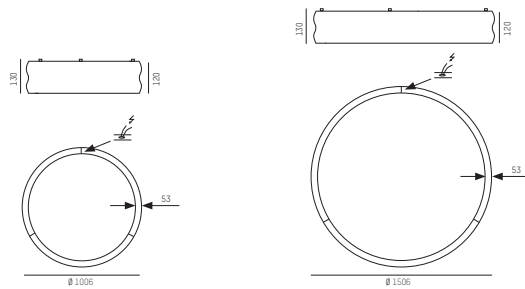
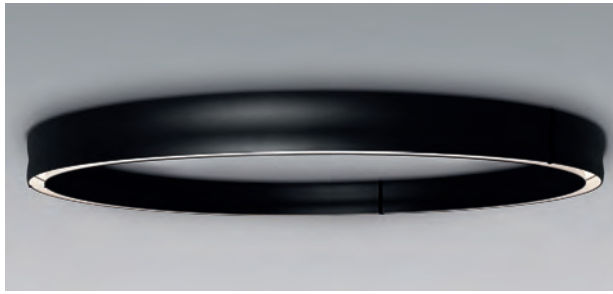

Smooth Design Ringleuchte aus Aluminium  
in weiß matt bzw. schwarz matt pulverbeschichtet  
direkt strahlend  
Konverter im Leuchtenprofil integriert  
Dekor-Einschubfolien zur individuellen Gestaltung

Ring lumineaire with smooth design in aluminium  
White matt or black matt powder-coated  
direct beam  
Built-in converter in profile  
Decoration slide-film for individual design

Lampada a forma di anello in alluminio  
Verniciata a polvere in bianco opaco o nero opaco  
Luce diretta  
Convertitore incluso nel profilo  
Pellicola decorativa per customizzazione

Suspension en forme d'anneau, en aluminium  
Finition laquée blanc mat ou noir mat  
Émission directe  
Convertisseur intégré dans le profil  
Film décoratif pour personnalisation



#### CHARM 1000 SD

220-240V AC - CRI >90 - Binning SDCM 3

SYS 91W - Ø: 1006mm	lm	W2	lm	W3	lm	W4
671-10101102W05Y	5320	5780	6010			
671-10101102W06Y	3690	4010	4170			



#### CHARM 1500 SD

220-240V AC - CRI >90 - Binning SDCM 3

SYS 137W - Ø: 1506mm	lm	W2	lm	W3	lm	W4
671-10201102W05Y	7970	8660	9000			
671-10201102W06Y	5530	6010	6250			



#### ARTIKELNUMMER ERGÄNZEN / COMPLETE CODE

W = LICHTFARBE/LIGHT COLOUR

Y = DIMMBAR/DIMMABLE

W2	LED 2700K = 3
W3	LED 3000K = 9
W4	LED 4000K = 4

S	switchable = 0
D	DALI dimm = d

#### CHARM 1000 DEKORFOLIEN / DECOR FOIL

3 Sets je Ring ordern / Order 3 pieces every ring  
zum Einschleiben in das Profil / to insert into the profile  
separat ordern / order separately

671-430000000050	W	LUMEN - 0%
671-430000000060	S	LUMEN - 40%
671-430000000130	R	LUMEN - 27%
671-430000000430	KU	LUMEN - 25%

#### CHARM 1500 DEKORFOLIEN / DECOR FOIL

3 Sets je Ring ordern / Order 3 pieces every ring  
zum Einschleiben in das Profil / to insert into the profile  
separat ordern / order separately

671-431000000050	W	LUMEN - 0%
671-431000000060	S	LUMEN - 40%
671-431000000130	R	LUMEN - 27%
671-431000000430	KU	LUMEN - 25%

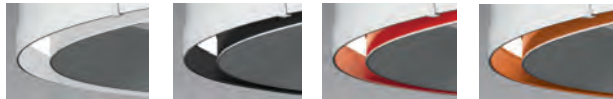



Smooth Design Systemhängeleuchte aus Aluminium in weiß matt bzw. schwarz matt pulverbeschichtet direkt oder direkt indirekt strahlend  
Konverter im Leuchtenprofil integriert  
Dekor-Einschubfolien zur individuellen Gestaltung

Smooth design system pendant in aluminium  
White matt or black matt powder-coated  
direct and indirect beam  
Built-in converter in profile  
Decoration slide-film for individual design

Lampada a sistema a forma di anello in alluminio  
Verniciata a polvere in bianco opaco o nero opaco  
Luce diretta ed indiretta  
Convertitore incluso nel profilo  
Pellicola decorativa per customizzazione

Suspension en forme d'anneau, en aluminium  
Finition laquée blanc mat ou noir mat  
Émission directe et indirecte  
Convertisseur intégré dans le profil  
Film décoratif pour personnalisation



IP 20

Abhängungen bei Segmenten inkludiert  
Segments are incl. suspensions

### CHARM 1000 SEGMENT PD

SYS 31W - 220-240V AC - CRI >90 - Binning SDCM 3

120° LINKS/LEFT

	lm	w2	lm	w3	lm	w4
671-30301102W05Y	W	1770	1920	2000		
671-30301102W06Y	S	1010	1230	1390		



### CHARM 1500 SEGMENT PD

SYS 46W - 220-240V AC - CRI >90 - Binning SDCM 3

120° LINKS/LEFT

	lm	w2	lm	w3	lm	w4
671-30401102W05Y	W	2650	2880	3000		
671-30401102W06Y	S	1840	2000	2080		



### CHARM 1500 SEGMENT PDI

SYS 79W - 220-240V AC - CRI >90 - Binning SDCM 3

120° LINKS/LEFT

	lm	w2	lm	w3	lm	w4
671-30402102W05Y	W	5820	6330	6580		
671-30402102W06Y	S	5010	5450	5660		



### CHARM 1000 SEGMENT PDI

SYS 51W - 220-240V AC - CRI >90 - Binning SDCM 3

120° LINKS/LEFT

	lm	w2	lm	w3	lm	w4
671-30302102W05Y	W	3720	4050	4210		
671-30302102W06Y	S	3180	3460	3600		



### CHARM 1000 SEGMENT PD

SYS 31W - 220-240V AC - CRI >90 - Binning SDCM 3

120° RECHTS/RIGHT

	lm	w2	lm	w3	lm	w4
671-30501102W05Y	W	1770	1920	2000		
671-30501102W06Y	S	1010	1230	1390		



### CHARM 1500 SEGMENT PD

SYS 46W - 220-240V AC - CRI >90 - Binning SDCM 3

120° RECHTS/RIGHT

	lm	w2	lm	w3	lm	w4
671-30601102W05Y	W	2650	2880	3000		
671-30601102W06Y	S	1840	2000	2080		



### CHARM 1000 SEGMENT PDI

SYS 51W - 220-240V AC - CRI >90 - Binning SDCM 3

120° RECHTS/RIGHT

	lm	w2	lm	w3	lm	w4
671-30502102W05Y	W	3720	4050	4210		
671-30502102W06Y	S	3180	3460	3600		



### CHARM 1500 SEGMENT PDI

SYS 79W - 220-240V AC - CRI >90 - Binning SDCM 3

120° RECHTS/RIGHT

	lm	w2	lm	w3	lm	w4
671-30602102W05Y	W	5820	6330	6580		
671-30602102W06Y	S	5010	5450	5660		



### CHARM 1000 SEGMENT PD

SYS 23W - 220-240V AC - CRI >90 - Binning SDCM 3

90° LINKS/LEFT

	lm	w2	lm	w3	lm	w4
671-30901102W05Y	W	1330	1440	1500		
671-30901102W06Y	S	920	1000	1040		



### CHARM 1500 SEGMENT PD

SYS 35W - 220-240V AC - CRI >90 - Binning SDCM 3

90° LINKS/LEFT

	lm	w2	lm	w3	lm	w4
671-31001102W05Y	W	1990	2160	2250		
671-31001102W06Y	S	1380	1500	1560		



### CHARM 1000 SEGMENT PDI

SYS 38W - 220-240V AC - CRI >90 - Binning SDCM 3

90° LINKS/LEFT

	lm	w2	lm	w3	lm	w4
671-30902102W05Y	W	2790	3030	3160		
671-30902102W06Y	S	2380	2590	2700		

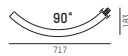

### CHARM 1500 SEGMENT PDI

SYS 58W - 220-240V AC - CRI >90 - Binning SDCM 3

90° LINKS/LEFT

	lm	w2	lm	w3	lm	w4
671-31002102W05Y	W	4370	4750	4940		
671-31002102W06Y	S	3760	4080	4250		



### CHARM 1000 SEGMENT PD

SYS 23W - 220-240V AC - CRI >90 - Binning SDCM 3

90° RECHTS/RIGHT

	lm	w2	lm	w3	lm	w4
671-31101102W05Y	W	1330	1440	1500		
671-31101102W06Y	S	920	1000	1040		



### CHARM 1500 SEGMENT PD

SYS 35W - 220-240V AC - CRI >90 - Binning SDCM 3

90° RECHTS/RIGHT

	lm	w2	lm	w3	lm	w4
671-31201102W05Y	W	1990	2160	2250		
671-31201102W06Y	S	1380	1500	1560		



### CHARM 1000 SEGMENT PDI

SYS 38W - 220-240V AC - CRI >90 - Binning SDCM 3

90° RECHTS/RIGHT

	lm	w2	lm	w3	lm	w4
671-31102102W05Y	W	2790	3030	3160		
671-31102102W06Y	S	2380	2590	2700		

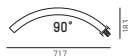

### CHARM 1500 SEGMENT PDI

SYS 58W - 220-240V AC - CRI >90 - Binning SDCM 3

90° RECHTS/RIGHT

	lm	w2	lm	w3	lm	w4
671-31202102W05Y	W	4370	4750	4940		
671-31202102W06Y	S	3760	4080	4250		



### ENDDECKEL SET / END PIECE SET

inkl. Abhängung und 2 x Endplatte  
inkl. suspension and 2 x end piece

671-440000000050	W
671-440000000060	S

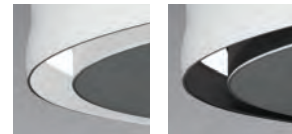

### EINSPESUNG / POWER FEED

H: max. 3000mm; 3 x 1,5mm<sup>2</sup>

671-450000000050	W
671-450000000060	S

H: max. 3000mm; 5 x 1,5mm<sup>2</sup>

671-45000000005d	W	DALI Dimm.
671-45000000006d	S	DALI Dimm.

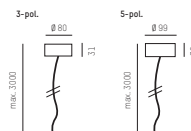

### CHARM SYSTEM PENDANT ACCESSOIRES

#### CHARM 1000 DEKORFOLIEN / DECOR FOIL

1 Set je Segment ordern / Order 1 set every segment  
zum Einschleiben in das Profil / to insert into the profile

für 120° SEGMENT LINKS ODER RECHTS  
für 120° SEGMENT LEFT OR RIGHT

671-430000000050	W	LUMEN - 0%
671-430000000060	S	LUMEN - 40%
671-430000000130	R	LUMEN - 27%
671-430000000430	RE	LUMEN - 25%

#### CHARM 1500 DEKORFOLIEN / DECOR FOIL

1 Set je Segment ordern / Order 1 set every segment  
zum Einschleiben in das Profil / to insert into the profile

für 120° SEGMENT LINKS ODER RECHTS  
für 120° SEGMENT LEFT OR RIGHT

671-431000000050	W	LUMEN - 0%
671-431000000060	S	LUMEN - 40%
671-431000000130	R	LUMEN - 27%
671-431000000430	RE	LUMEN - 25%

#### CHARM 1000 DEKORFOLIEN / DECOR FOIL

1 Set je Segment ordern / Order 1 set every segment  
zum Einschleiben in das Profil / to insert into the profile

für 90° SEGMENT LINKS ODER RECHTS  
für 90° SEGMENT LEFT OR RIGHT

671-434000000050	W	LUMEN - 0%
671-434000000060	S	LUMEN - 40%
671-434000000130	R	LUMEN - 27%
671-434000000430	RE	LUMEN - 25%

#### CHARM 1500 DEKORFOLIEN / DECOR FOIL

1 Set je Segment ordern / Order 1 set every segment  
zum Einschleiben in das Profil / to insert into the profile

für 90° SEGMENT LINKS ODER RECHTS  
für 90° SEGMENT LEFT OR RIGHT

671-435000000050	W	LUMEN - 0%
671-435000000060	S	LUMEN - 40%
671-435000000130	R	LUMEN - 27%
671-435000000430	RE	LUMEN - 25%

#### CHARM 1130 DEKORFOLIEN / DECOR FOIL

1 Set je Segment ordern / Order 1 set every segment  
zum Einschleiben in das Profil / to insert into the profile

für SEGMENT GERADE  
für SEGMENT GERADE

671-432000000050	W	LUMEN - 0%
671-432000000060	S	LUMEN - 40%
671-432000000130	R	LUMEN - 27%
671-432000000430	RE	LUMEN - 25%

#### CHARM 2250 DEKORFOLIEN / DECOR FOIL

1 Set je Segment ordern / Order 1 set every segment  
zum Einschleiben in das Profil / to insert into the profile

für SEGMENT GERADE  
für SEGMENT GERADE

671-433000000050	W	LUMEN - 0%
671-433000000060	S	LUMEN - 40%
671-433000000130	R	LUMEN - 27%
671-433000000430	RE	LUMEN - 25%

### ARTIKELNUMMER ERGÄNZEN / COMPLETE CODE

W = LICHTFARBE/LIGHT COLOUR

Y = DIMMBAR/DIMMABLE

w2	LED 2700K = 3
w3	LED 3000K = 9
w4	LED 4000K = 4

s	switchable = 0
d	DALI dimm = d

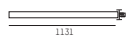



Reflector silver Reflector black



1 - 25mm

150 mm, ET 136 mm

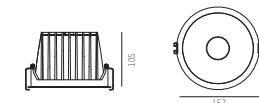

Downlight aus Aluminium  
Schwarz oder weiß pulverbeschichtet  
Perfekte entblendung durch schwarzen  
Kunststoff hochglanz Reflektor schwarz oder silber  
Konverter separat ordern

Recessed downlight in aluminium  
Black or white powder-coated  
Perfect anti-glare due to black or silver high-gloss grid  
Please order converter separately

Downlight in alluminio, Verniciato a polvere in nero  
Verniciato a polvere in nero o bianco  
Anti-abbagliamento garantito da una griglia nera lucida  
Converter da ordinare separatamente

Downlight encastré en aluminium, laquée noir  
Laquée noir ou blanc  
Grille basse-luminance  
convertisseur à commander séparément

UGR<16

LED 3500K auf Anfrage / on request

Universal-Betoneinbaugehäuse: siehe Seite 498-499  
Universal concrete housing: see page 498-499

A++ - A

IP 20

### DARK NIGHT MEDIUM R

Binning SDCM 3 exkl. Konverter / excl. converter

Power feed	500mA - 18W				700mA - 25W				900mA - 33W									
	lm	W2	lm	W3	lm	W4	lm	W2	lm	W3	lm	W4						
Order converter not dimm.	24-127532				24-127534				24-127536									
Order converter DALI dimm.	24-127490				24-127490				24-127490									
COLOUR REFLECTOR	1580	1640	1760	2100	2190	2340	2580	2680	2870	1580	1640	1760	2100	2190	2340	2580	2680	2870

### ARTIKELNUMMER ERGÄNZEN / COMPLETE CODE

WW = LICHTFARBE / LIGHT COLOUR

XX = FARBE / COLOUR

W2 LED 2700K = 43 PREMIUM CRI >90  
W3 LED 3000K = 49 PREMIUM CRI >90  
W4 LED 4000K = 24 CRI >90

W white = 05  
S black = 06

### LED CONVERTER DARK NIGHT M

24-127532	W	schaltbar/switchable	for 500mA	L 130 x B 42 x H 30mm
24-127534	W	schaltbar/switchable	for 700mA	L 130 x B 42 x H 30mm
24-127536	W	schaltbar/switchable	for 900mA	L 130 x B 42 x H 30mm
24-127490	W	DALI dimm.	for 700 - 900mA	L 130 x B 42 x H 30mm





Reflector silver Reflector black



1 - 25mm

78 mm, ET 106 mm

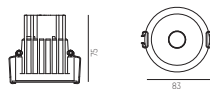

Downlight aus Aluminium  
Schwarz oder weiß pulverbeschichtet  
Perfekte entblendung durch schwarzen  
Kunststoff hochglanz Reflektor schwarz oder silber  
Konverter separat ordern

Recessed downlight in aluminium  
Black or white powder-coated  
Perfect anti-glare due to black or silver high-gloss grid  
Please order converter separately

Downlight in alluminio, Verniciato a polvere in nero  
Verniciato a polvere in nero o bianco  
Anti-abbagliamento garantito da una griglia nera lucida  
Converter da ordinare separatamente

Downlight encastré en aluminium, laquée noir  
Laquée noir ou blanc  
Grille basse-luminance  
convertisseur à commander séparément

UGR<16

LED 3500K auf Anfrage / on request

Universal-Betoneinbaugehäuse: siehe Seite 498-499  
Universal concrete housing: see page 498-499

A++ - A

IP 20

#### DARK NIGHT SMALL R

Binning SDCM 3 exkl. Konverter / excl. converter

Power feed

350mA - 13W

500mA - 19W

Order converter not dimm.

24-127530

24-127532

Order converter DALI dimm.

24-123403

24-123403

COLOUR REFLECTOR	lm W2		lm W3		lm W4	
	W2	W3	W2	W3	W2	W3
684-0010205WWXX	1070	1110	1190	1430	1490	1600
684-0010305WWXX	1070	1110	1190	1430	1490	1600

#### ARTIKELNUMMER ERGÄNZEN / COMPLETE CODE

WW = LICHTFARBE / LIGHT COLOUR

XX = FARBE / COLOUR

W2	LED 2700K = 43	PREMIUM CRI >90
W3	LED 3000K = 49	PREMIUM CRI >90
W4	LED 4000K = 24	CRI >90

W	white = 05
S	black = 06

#### LED CONVERTER DARK NIGHT S

24-127530	W	schaltbar / switchable	for 350mA	L 130 x B 42 x H 30mm
24-127532	W	schaltbar / switchable	for 500mA	L 130 x B 42 x H 30mm
24-123403	W	DALI dimm.	for 350 - 500mA	L 111 x B 52 x H 22mm







Superschlanke LED Stehleuchte aus Aluminium  
 Oberfläche eloxiert, weiß oder schwarz pulverbeschichtet  
 Linsen mit einzel- oder doppelarbeitsplatz Optik  
 Perfekte Entblendung durch schwarzen Hochglanzraster  
 mit Tageslichtsensor, Bewegungsmelder und Schwarm-  
 funktion

Super-slim LED floor lamp in aluminium  
 Anodised surface, black or white powder-coated  
 Recessed lens with single or double workstation optic  
 Perfect anti-glare due to black high-gloss grid  
 Daylight control, motion detector and wireless swarm  
 network-function

Piantana a LED a ingombro ridotto in alluminio  
 Superficie anodizzata o verniciata a polvere in nero o bianco  
 Lente retrocessa con ottica singola o doppia  
 Anti-abbagliamento garantito da una griglia nera lucida  
 Sensore di movimento e rilevatore quantità di luce e  
 wireless funzione di rete

Lampadaire extra-fin à LED en aluminium  
 Finition anodisée, laqué blanc ou noir  
 Optique à émission simple ou double  
 Grille basse-luminance  
 Détecteur de mouvement, capteur de lumière et fonction  
 réseau sans fil.

UGR < 16

W3 = LED 3000K  
 W4 = LED 4000K

A++ - A

IP 20

#### LENS SINGLE F

220-240V AC/DC - CRI >80 - Binning SDCM 3

SYS 53W

646-002010329XXY W3 6100lm  
 646-002010324XXY W4 6100lm

#### LENS DOUBLE F

220-240V AC/DC - CRI >80 - Binning SDCM 3

SYS 111W

646-002020529XXY W3 11480lm  
 646-002020524XXY W4 11480lm

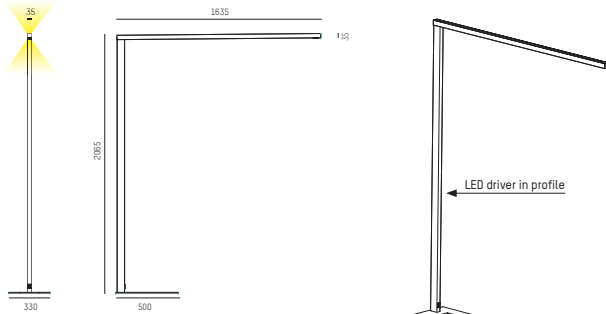

#### LENS TASTER / PUSH BUTTON ZIGBEE GREEN POWER

Optionaler Funktaster (separat ordern) / Optional radio push button (order separately)  
 ON/OFF & dimm.

646-000040000050 W 88  
 646-000040000060 S 88

ARTIKELNUMMER ERGÄNZEN / COMPLETE CODE

XX = FARBE/COLOUR

Y = DIMMBAR/DIMMABLE

W white = 05  
 S black = 06  
 RE aluminium anodized = 08

MS Motion swarm = i  
 T push-button dimmable = t (without sensor)

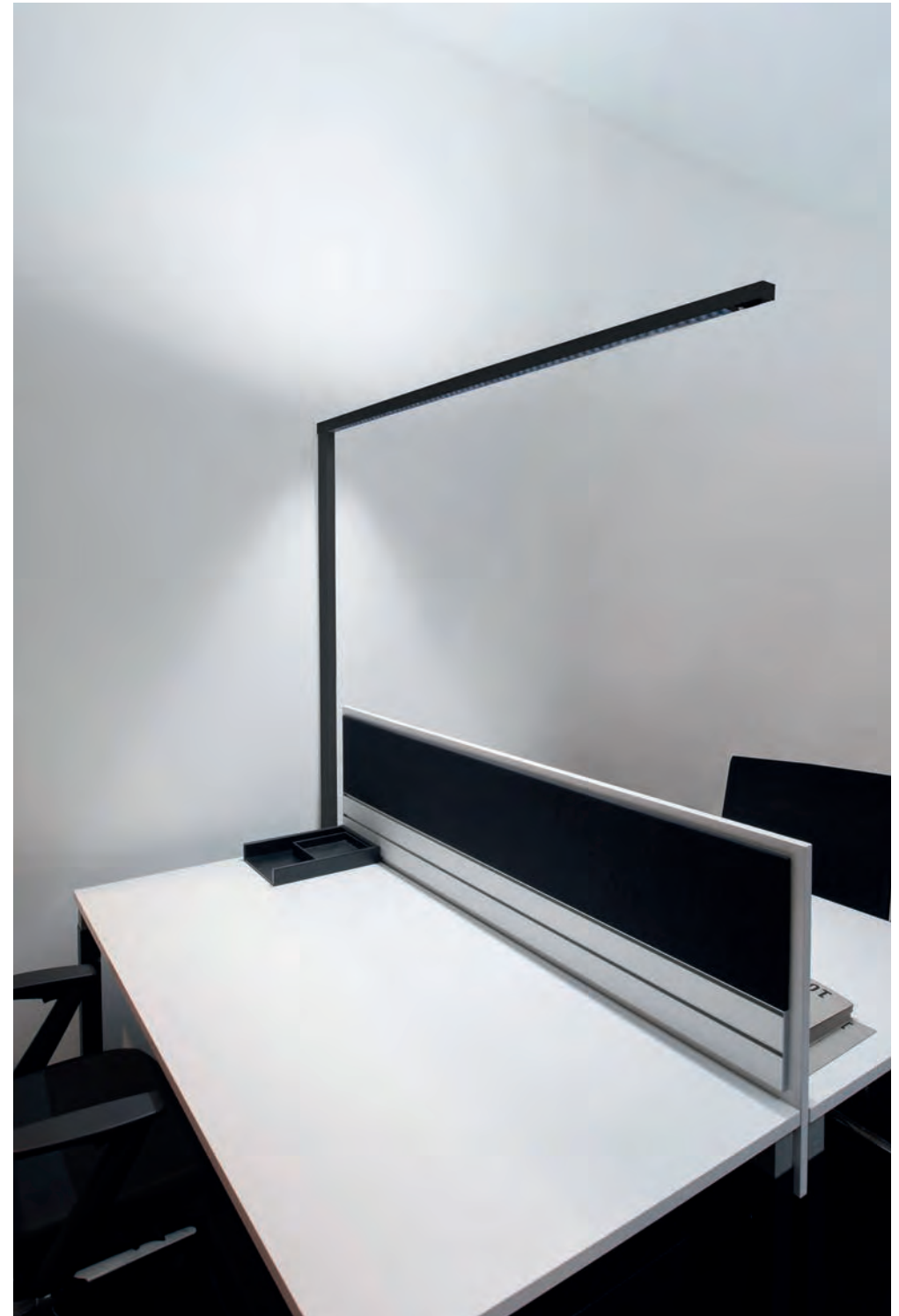



Superschlanke Hängeleuchte aus Aluminium  
 Oberfläche eloxiert, weiß oder schwarz pulverbeschichtet  
 Linsen mit einzel- oder doppelarbeitsplatz Optik  
 Perfekte Entblendung durch schwarzen Hochglanzraster  
 Schaltbar, DALI dimmbar oder mit Tageslichtsensor,  
 Bewegungsmelder und Schwarmfunktion

Super-slim LED suspension in aluminium  
 Anodised surface, black or white powder-coated  
 Recessed lens with single or double workstation optics  
 Perfect anti-glare due to black high-gloss grid  
 Switchable, DALI dimmable or daylight control, motion  
 detector and wireless swarm network-function

Sospensione a LED a ingombro ridotto in alluminio  
 Superficie anodizzata o verniciata a polvere in nero o bianco  
 Lente retrocessa con ottica singola o doppia  
 Anti-abbagliamento garantito da una griglia nera lucida  
 Regolabile, dimmerabile DALI, sensore di movimento e  
 rilevatore quantità di luce e wireless funzione di rete

Suspension à LED en aluminium  
 Finition anodisée ou laquée blanc ou noir  
 Optique à émission simple ou double  
 Grille basse-luminance  
 Variation DALI, détecteur de mouvement, capteur de  
 lumière et fonction réseau sans fil.

UGR < 16

Light beam:

W3 = LED 3000K  
 W4 = LED 4000K

A\*\* - A

IP 20

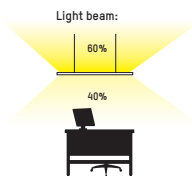

#### LENS SINGLE PDI

220-240V AC/DC - CRI >80 - Binning SDCM 3

SYS 53W

646-003010329XXY  
 646-003010324XXY

W3 6100lm  
 W4 6100lm



#### LENS DOUBLE PDI

220-240V AC/DC - CRI >80 - Binning SDCM 3

SYS 111W

646-003020529XXY  
 646-003020524XXY

W3 11480lm  
 W4 11480lm

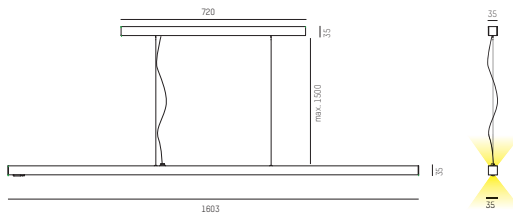

#### LENS TASTER / PUSH BUTTON ZIGBEE GREEN POWER

Optionaler Funktaster (separat ordern) / Optional radio push button (order separately)  
 ON/OFF & dimm.

646-000040000050  
 646-000040000060

W  
 S



#### ARTIKELNUMMER ERGÄNZEN / COMPLETE CODE

XX = FARBE/COLOUR

Y = DIMMBAR/DIMMABLE

W white = 05  
 S black = 06  
 RE aluminium anodized = 08

M Motion swarm = i  
 D DALI dimm = d  
 S switchable = 0



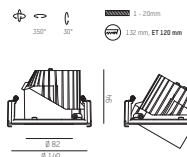
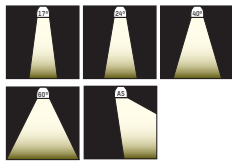

Einbaudownlight aus Aluminiumdruckguss  
 Feinstrukturlack in weiß, schwarz oder silber matt  
 BASIC Reflektor in 5 Ausstrahlwinkel  
 Strahlenelement 350° drehbar und 30° schwenkbar  
 Energieeffiziente COB LED mit Farbwiedergabe

Aluminium downlighter  
 Microstructure painting in white, black or silver matt  
 BASIC reflector in 5 beam angles  
 350° swiveling and 30° tilting  
 Energy efficient COB LED, colour rendering

Incasso in alluminio  
 Verniciato bianco, nero o grigio opaco  
 BASIC riflettore in 5 fasci di emissione  
 Greivole a 350°, orientabile a 30°  
 Efficienti COB LED a resa cromatica



Lumenwerte ohne Glas  
 Lumen values without glass

### MOVA BASIC R

Binning SDCM 3 exkl. Konverter / excl. converter

Power feed	350mA - 12W			500mA - 17W			700mA - 24W			800mA - 28W		
Order converter not dimm.	24-127530	24-127532	24-127534	24-127536	24-127538	24-127538	24-127484	24-127484	24-127484	24-127484	24-127484	
Order converter Dali dimm.	24-127480	24-127480	24-127480	24-127480	24-127480	24-127480	24-127480	24-127480	24-127480	24-127480	24-127480	
lm	1260	1500	1570	1750	2070	2180	2350	2770	2920	2620	3100	3250
lm	1260	1500	1570	1750	2070	2180	2350	2770	2920	2620	3100	3250
lm	1260	1500	1570	1750	2070	2180	2350	2770	2920	2620	3100	3250
lm	1260	1500	1570	1750	2070	2180	2350	2770	2920	2620	3100	3250
lm	1260	1500	1570	1750	2070	2180	2350	2770	2920	2620	3100	3250
lm	1260	1500	1570	1750	2070	2180	2350	2770	2920	2620	3100	3250

Power feed	900mA - 29W			1050mA - 35W		
Order converter not dimm.	24-127536	24-127538	24-127538	24-127538	24-127538	24-127480
Order converter Dali dimm.	24-127480	24-127480	24-127480	24-127480	24-127480	24-127480
lm	3140	3640	3810	3540	4100	4280
lm	3140	3640	3810	3540	4100	4280
lm	3140	3640	3810	3540	4100	4280
lm	3140	3640	3810	3540	4100	4280
lm	3140	3640	3810	3540	4100	4280
lm	3140	3640	3810	3540	4100	4280

### ARTIKELNUMMER ERGÄNZEN / COMPLETE CODE

<b>C</b> = COVER	<b>W</b> = LICHTFARBE/LIGHT COLOUR	<b>XX</b> = FARBE/COLOUR
without glass = 0	LED 2700K = 43 PREMIUM CRI >90	silver matt = 44
with glass = 1	LED 3000K = 49 PREMIUM CRI >90	white = 55
	LED 4000K = 24 CRI >90	black = 66

### LED CONVERTER MOVA BASIC R

Code	Function	Power	Dimensions
24-127530	schaltbar/switchable	for 350mA	L 130 x B 42 x H 30mm
24-127532	schaltbar/switchable	for 500mA	L 130 x B 42 x H 30mm
24-127534	schaltbar/switchable	for 700mA	L 130 x B 42 x H 30mm
24-127484	schaltbar/switchable	for 800mA	L 147 x B 44 x H 30mm
24-127536	schaltbar/switchable	for 900mA	L 130 x B 42 x H 30mm
24-127538	schaltbar/switchable	for 1050mA	L 130 x B 42 x H 30mm
24-127480	DALI Dimm.	for 300 - 1050mA	L 130 x B 42 x H 30mm



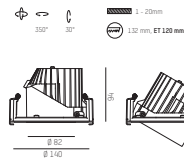
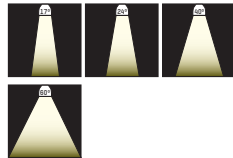

Einbaudownlight aus Aluminiumdruckguss  
 Feinstrukturlack in weiß, schwarz oder silber matt  
 HIGH EFFICIENCY Reflektor in 4 Ausstrahlwinkel  
 Strahlenelement 350° drehbar und 30° schwenkbar

Die cast Aluminium downlighter  
 Microstructure painting in white, black or silver matt  
 HIGH EFFICIENCY reflector in 4 beam angles  
 350° swiveling and 30° tilting

Incasso in alluminio pressofuso  
 Verniciato bianco, nero o grigio opaco  
 HIGH EFFICIENCY riflettore in 4 fasci di emissione  
 Girevole a 350°, orientabile a 30°

A++ - A

IP 20

Lumenwerte ohne Glas  
 Lumen values without glass

#### MOVA HIGH EFFICIENCY R

Binning SOCR 3 exkl. Konverter / excl. converter

Power feed	350mA - 12W			500mA - 17W			700mA - 24W			800mA - 28W		
Order converter not dimm.	24-127530	24-127532	24-127534	24-127536	24-127538	24-127540	24-127532	24-127534	24-127536	24-127484	24-127490	
Order converter Dali dimm.	24-127490	24-127490	24-127490	24-127490	24-127490	24-127490	24-127490	24-127490	24-127490	24-127490	24-127490	
	lm	lm	lm	lm	lm	lm	lm	lm	lm	lm	lm	
695-51C0022WWXX0	1370	1620	1700	1900	2240	2360	2540	3000	3150	2840	3350	
695-51C0023WWXX0	1370	1620	1700	1900	2240	2360	2540	3000	3150	2840	3350	
695-51C0024WWXX0	1370	1620	1700	1900	2240	2360	2540	3000	3150	2840	3350	
695-51C0025WWXX0	1370	1620	1700	1900	2240	2360	2540	3000	3150	2840	3350	

Power feed	900mA - 29W			1050mA - 35W		
Order converter not dimm.	24-127536	24-127538	24-127540	24-127538	24-127540	24-127490
Order converter Dali dimm.	24-127490	24-127490	24-127490	24-127490	24-127490	24-127490
	lm	lm	lm	lm	lm	lm
695-51C0023WWXX0	3400	3940	4120	3840	4440	4620
695-51C0024WWXX0	3400	3940	4120	3840	4440	4620
695-51C0025WWXX0	3400	3940	4120	3840	4440	4620

#### ARTIKELNUMMER ERGÄNZEN / COMPLETE CODE

C = COVER	W = LICHTFARBE/LIGHT COLOUR	XX = FARBE/COLOUR
without glass = 0	W LED 2700K = 43 PREMIUM CRI >90	silver matt = 44
with glass = 1	W LED 3000K = 49 PREMIUM CRI >90	white = 55
	W LED 4000K = 24 CRI >90	black = 66

#### LED CONVERTER MOVA HIGH EFFICIENCY R

Code	W	schaltbar/switchable	for	L
24-127530	W	schaltbar/switchable	for 350mA	L 130 x B 42 x H 30mm
24-127532	W	schaltbar/switchable	for 500mA	L 130 x B 42 x H 30mm
24-127534	W	schaltbar/switchable	for 700mA	L 130 x B 42 x H 30mm
24-127484	W	schaltbar/switchable	for 800mA	L 147 x B 44 x H 30mm
24-127536	W	schaltbar/switchable	for 900mA	L 130 x B 42 x H 30mm
24-127538	W	schaltbar/switchable	for 1050mA	L 130 x B 42 x H 30mm
24-127490	W	DALI Dimm.	for 300 - 1050mA	L 130 x B 42 x H 30mm



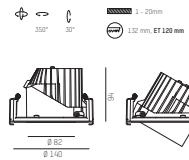
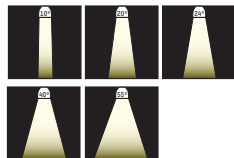

Einbaudownlight aus Aluminiumdruckguss  
 Feinstrukturlack in weiß, schwarz oder silber matt  
 Linse für ein exaktes Lichtbild ohne Streulicht  
 Strahlerelement 350° drehbar und 30° schwenkbar  
 Energieeffiziente COB LED mit Farbwiedergabe

Die cast aluminium Aluminium downlighter  
 Microstructure painting in white, black or silver matt  
 Lens for an exact light image without stray light  
 350° swiveling and 30° tilting  
 Energy efficient COB LED, colour rendering

Incasto in alluminio pressofuso  
 verniciato bianco, nero o grigio opaco  
 Lente per un'immagine di luce esatta senza luce diffusa  
 Greivole a 350°, orientabile a 30°  
 Efficienti COB LED a resa cromatica

A+ - A  
 IP 20

#### MOVA LENS R

Binning SDCM 3 excl. Konverter / excl. converter

Power feed	350mA - 12W				500mA - 17W			
	lm	lm	lm	lm	lm	lm	lm	lm
Order converter not dimm.	24-127530				24-127532			
Order converter Dali dimm.	24-127490				24-127490			
695-51C0031WWXX	780	830	950		940	1000	1140	
695-51C0032WWXX	1240	1440	1510		1730	2000	2100	
695-51C0033WWXX	1350	1560	1640		1870	2160	2280	
695-51C0034WWXX	1270	1470	1550		1770	2040	2150	
695-51C0035WWXX	1010	1160	1220		1400	1610	1700	

Power feed	700mA - 24W				800mA - 28W				900mA - 31W				1050mA - 37W			
	lm	lm	lm	lm	lm	lm	lm	lm	lm	lm	lm	lm	lm	lm	lm	
Order converter not dimm.	24-127534				24-127484				24-127536				24-127538			
Order converter Dali dimm.	24-127490				24-127490				24-127490				24-127538			
695-51C0032WWXX	2310	2670	2810		2580	2980	3130		2850	3290	3450		3210	3710	3880	
695-51C0033WWXX	2510	2900	3040		2800	3240	3390		3090	3570	3740		3480	4020	4210	
695-51C0034WWXX	2370	2740	2870		2640	3050	3200		2910	3370	3530		3260	3800	3970	
695-51C0035WWXX	1870	2160	2270		2090	2410	2530		2300	2660	2790		2600	3000	3140	

#### ARTIKELNUMMER ERGÄNZEN / COMPLETE CODE

W - LICHTFARBE/LIGHT COLOUR

XX - FARBE/COLOUR

LED 2700K = 43 PREMIUM CRI >90  
 LED 3000K = 48 PREMIUM CRI >90  
 LED 4000K = 24 CRI >90

silver matt = 44  
 white = 55  
 black = 66

#### LED CONVERTER MOVA LENS R

Code	Control	Power	Dimensions
24-127530	schaltbar/switchable	for 350mA	L 130 x B 42 x H 30mm
24-127532	schaltbar/switchable	for 500mA	L 130 x B 42 x H 30mm
24-127534	schaltbar/switchable	for 700mA	L 130 x B 42 x H 30mm
24-127484	schaltbar/switchable	for 800mA	L 147 x B 44 x H 30mm
24-127536	schaltbar/switchable	for 900mA	L 130 x B 42 x H 30mm
24-127538	schaltbar/switchable	for 1050mA	L 130 x B 42 x H 30mm
24-127490	DALI Dimm.	for 300 - 1050mA	L 130 x B 42 x H 30mm



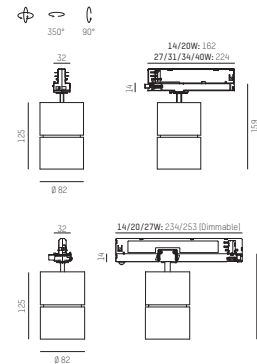
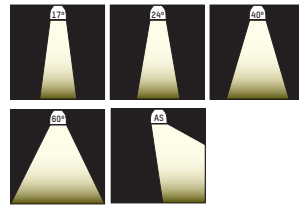

LED Stromeisenstrahler aus Aluminiumdruckguss  
Feinstrukturlack in weiß, schwarz oder silber matt  
BASIC Reflektor in 5 Ausstrahlwinkeln  
LED Konverter im Adapter integriert  
BLUETOOTH über Molto Luce Smart APP steuerbar

Die cast aluminium LED track spotlight  
Microstructure painting in white, black or silver matt  
BASIC reflector in 5 beam angles  
Integrated LED Driver  
BLUETOOTH with Molto Luce Smart APP controllable

Faretto in alluminio pressofuso per binario  
verniciato bianco, nero o grigio opaco  
BASIC riflettore in 5 fascie di emissione  
LED driver integrato  
BLUETOOTH controllabile da Molto Luce Smart APP

Spot sur rail en aluminium  
Finition laquée blanc, noir ou gris mat  
BASIC réflecteur, 5 faisceaux disponibles  
Pilotage de LED intégré  
BLUETOOTH contrôlable par Molto Luce Smart APP

LED 3500K auf Anfrage / on request  
Sonderlichtfarben auf Anfrage  
Special light colours on request

A++ - A

IP 20 CE

#### MOVA BASIC TRACK

220-240V AC - Binning SDCM 3 - PASSIVE COOLING

##### SYS 14W

	W2	W3	W4
695-11CX112WXXY	1260lm	1500lm	1570lm
695-11CX113WXXY	1260lm	1500lm	1570lm
695-11CX114WXXY	1260lm	1500lm	1570lm
695-11CX115WXXY	1260lm	1500lm	1570lm
695-11CX116WXXY	1260lm	1500lm	1570lm

##### SYS 20W

	W2	W3	W4
695-11CX212WXXY	1750lm	2070lm	2180lm
695-11CX213WXXY	1750lm	2070lm	2180lm
695-11CX214WXXY	1750lm	2070lm	2180lm
695-11CX215WXXY	1750lm	2070lm	2180lm
695-11CX216WXXY	1750lm	2070lm	2180lm

##### SYS 27W

	W2	W3	W4
695-11CX312WXXY	2350lm	2770lm	2920lm
695-11CX313WXXY	2350lm	2770lm	2920lm
695-11CX314WXXY	2350lm	2770lm	2920lm
695-11CX315WXXY	2350lm	2770lm	2920lm
695-11CX316WXXY	2350lm	2770lm	2920lm

##### SYS 31W

	W2	W3	W4
695-11CX412WXXY	2620lm	3100lm	3250lm
695-11CX413WXXY	2620lm	3100lm	3250lm
695-11CX414WXXY	2620lm	3100lm	3250lm
695-11CX415WXXY	2620lm	3100lm	3250lm
695-11CX416WXXY	2620lm	3100lm	3250lm

##### SYS 34W

	W2	W3	W4
695-11CX513WXXY	3140lm	3640lm	3810lm
695-11CX514WXXY	3140lm	3640lm	3810lm

##### SYS 40W

	W2	W3	W4
695-11CX613WXXY	3540lm	4100lm	4280lm
695-11CX614WXXY	3540lm	4100lm	4280lm

Lumeninfo ohne Glas  
Lumeninfo without glass

#### ARTIKELNUMMER ERGÄNZEN / COMPLETE CODE

C = COVER

WW = LICHTFARBE/LIGHT COLOUR

X....XX = FARBE/COLOUR

Y = DIMMBAR/DIMMABLE

without glass = 0  
with glass = 1

W2 LED 2700K = 43 PREMIUM CRI >90  
W3 LED 3000K = 49 PREMIUM CRI >90  
W4 LED 4000K = 24 CRI >90

SM silver matt = 4....44  
W white = 5....55  
S black = 6....66

S switchable = 0  
P PULSE DALI dimm = p  
B BLUETOOTH dimm = b



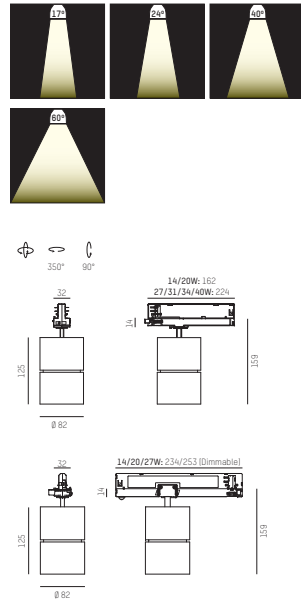

LED Strahlschiene aus Aluminiumdruckguss  
 Feinstrukturlack in weiß, schwarz oder silber matt  
 HIGH EFFICIENCY Reflektor in 4 Ausstrahlwinkel  
 LED Konverter im Adapter integriert  
 BLUETOOTH über Molto Luce Smart APP steuerbar

Die cast aluminium LED track spotlight  
 Microstructure painting in white, black or silver matt  
 HIGH EFFICIENCY reflector in 4 beam angles  
 Integrated LED Driver  
 BLUETOOTH with Molto Luce Smart APP controllable

Faretto in alluminio pressofuso per binario  
 verniciato bianco, nero o grigio opaco  
 HIGH EFFICIENCY riflettore in 4 fasci di emissione  
 LED driver integrato  
 BLUETOOTH controllabile da Molto Luce Smart APP

Spot sur rail en aluminium  
 Finition laquée blanc, noir ou gris mat  
 HIGH EFFICIENCY réflecteur, 4 faisceaux disponibles  
 Pilotage de LED intégré  
 BLUETOOTH contrôlable par Molto Luce Smart APP

LED 3500K auf Anfrage / on request  
 Sonderlichtfarben auf Anfrage  
 Special light colours on request

A++ - A

IP 20

### MOVA HIGH EFFICIENCY TRACK

220-240V AC - Binning SDCM 3 - PASSIVE COOLING

#### SYS 14W

	W2	W3	W4
695-11CX122WXXY	1370lm	1620lm	1700lm
695-11CX123WXXY	1370lm	1620lm	1700lm
695-11CX124WXXY	1370lm	1620lm	1700lm
695-11CX125WXXY	1370lm	1620lm	1700lm

#### SYS 20W

	W2	W3	W4
695-11CX222WXXY	1900lm	2240lm	2360lm
695-11CX223WXXY	1900lm	2240lm	2360lm
695-11CX224WXXY	1900lm	2240lm	2360lm
695-11CX225WXXY	1900lm	2240lm	2360lm

#### SYS 27W

	W2	W3	W4
695-11CX322WXXY	2540lm	3000lm	3150lm
695-11CX323WXXY	2540lm	3000lm	3150lm
695-11CX324WXXY	2540lm	3000lm	3150lm
695-11CX325WXXY	2540lm	3000lm	3150lm

#### SYS 31W

	W2	W3	W4
695-11CX422WXXO	2840lm	3350lm	3510lm
695-11CX423WXXO	2840lm	3350lm	3510lm
695-11CX424WXXO	2840lm	3350lm	3510lm
695-11CX425WXXO	2840lm	3350lm	3510lm

#### SYS 34W

	W2	W3	W4
695-11CX523WXXO	3400lm	3940lm	4120lm
695-11CX524WXXO	3400lm	3940lm	4120lm
695-11CX525WXXO	3400lm	3940lm	4120lm

#### SYS 40W

	W2	W3	W4
695-11CX623WXXO	3840lm	4440lm	4620lm
695-11CX624WXXO	3840lm	4440lm	4620lm
695-11CX625WXXO	3840lm	4440lm	4620lm

Lumeninfo ohne Glas  
 Lumeninfo without glass

### ARTIKELNUMMER ERGÄNZEN / COMPLETE CODE

C = COVER

WW = LICHTFARBE/LIGHT COLOUR

X....XX = FARBE/COLOUR

Y = DIMMBAR/DIMMABLE

without glass = 0  
 with glass = 1

W2 LED 2700K = 43 PREMIUM CRI >90  
 W3 LED 3000K = 49 PREMIUM CRI >90  
 W4 LED 4000K = 24 CRI >90

S3 silver matt = 4....44  
 W white = 5....55  
 S black = 6....66

0 switchable = 0  
 P PULSE DALI dimm = p  
 B BLUETOOTH dimm = b



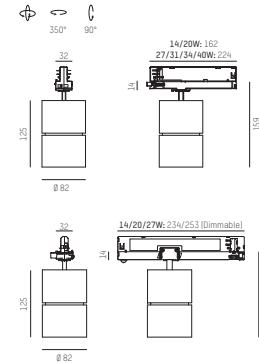
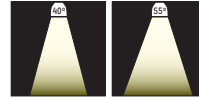
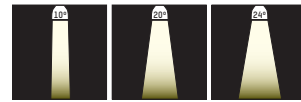

LED Strahler aus Aluminiumdruckguss  
Feinstrukturlack in weiß, schwarz oder silber matt  
Linse für ein exaktes Lichtbild ohne Streulicht  
LED Konverter im Adapter integriert  
BLUETOOTH über Molto Luce Smart APP steuerbar

Die cast aluminium LED track spotlight  
Microstructure painting in white, black or silver matt  
Lens for an exact light image without stray light  
Integrated LED Driver  
BLUETOOTH with Molto Luce Smart APP controllable

Faretto in alluminio pressofuso per binario  
verniciato bianco, nero o grigio opaco  
Ottica in alluminio in 5 fasci di emissione  
LED driver integrato  
BLUETOOTH controllabile da Molto Luce Smart APP

Spot sur rail en aluminium  
Finition laquée blanc, noir ou gris mat  
Réflecteurs aluminium, 5 faisceaux disponibles  
Pilotage de LED intégré  
BLUETOOTH contrôlable par Molto Luce Smart APP

LED 3500K auf Anfrage / on request  
Sonderlichtfarben auf Anfrage  
Special light colours on request

A++ - A

IP 20

ARTIKELNUMMER ERGÄNZEN / COMPLETE CODE

WW = LICHTFARBE/LIGHT COLOUR

X...XX = FARBE/COLOUR

Y = DIMMBAR/DIMMABLE

W2 LED 2700K = 43 PREMIUM CRI >90  
W3 LED 3000K = 49 PREMIUM CRI >90  
W4 LED 4000K = 24 CRI >90

S silver matt = 4...44  
W white = 5...55  
B black = 6...66

S switchable = 0  
P PULSE DALI dimm = p  
B BLUETOOTH dimm = b

### MOVA LENS TRACK

220-240V AC - Binning SDCM 3 - PASSIVE COOLING

#### SYS 14W

	W2	W3	W4
695-110X131WWXXY	780lm	830lm	950lm
695-110X132WWXXY	1240lm	1440lm	1510lm
695-110X133WWXXY	1350lm	1560lm	1640lm
695-110X134WWXXY	1270lm	1470lm	1550lm
695-110X135WWXXY	1010lm	1160lm	1220lm

#### SYS 27W

	W2	W3	W4
695-110X332WWXXY	2310lm	2670lm	2810lm
695-110X333WWXXY	2510lm	2900lm	3040lm
695-110X334WWXXY	2370lm	2740lm	2870lm
695-110X335WWXXY	1870lm	2160lm	2270lm

#### SYS 35W

	W2	W3	W4
695-110X732WWXX0	2850lm	3290lm	3450lm
695-110X733WWXX0	3090lm	3570lm	3740lm
695-110X734WWXX0	2910lm	3370lm	3530lm
695-110X735WWXX0	2300lm	2660lm	2790lm

#### SYS 20W

	W2	W3	W4
695-110X231WWXXY	940lm	1000lm	1140lm
695-110X232WWXXY	1730lm	2000lm	2100lm
695-110X233WWXXY	1870lm	2160lm	2280lm
695-110X234WWXXY	1770lm	2040lm	2150lm
695-110X235WWXXY	1400lm	1610lm	1700lm

#### SYS 31W

	W2	W3	W4
695-110X432WWXX0	2580lm	2980lm	3130lm
695-110X433WWXX0	2800lm	3240lm	3390lm
695-110X434WWXX0	2640lm	3050lm	3200lm
695-110X435WWXX0	2090lm	2410lm	2530lm

#### SYS 42W

	W2	W3	W4
695-110X832WWXX0	3210lm	3710lm	3880lm
695-110X833WWXX0	3480lm	4020lm	4210lm
695-110X834WWXX0	3280lm	3800lm	3970lm
695-110X835WWXX0	2600lm	3000lm	3140lm



# MOVA TRACK

Design: INHOUSE



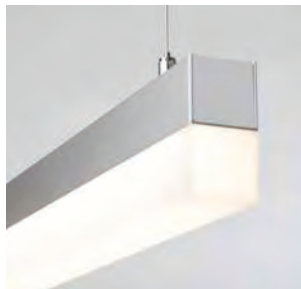
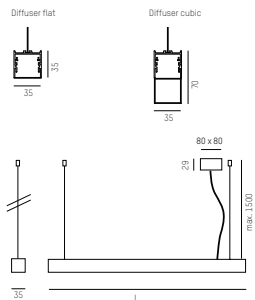

## RIDE PD

220-240V AC/DC - CRI >90 - Binning SDCM 3

### SYS 15W

1. W2 = 1230lm	W3 = 1340lm	W4 = 1400lm
2. W2 = 1390lm	W3 = 1510lm	W4 = 1570lm
3. W2 = 1170m	W3 = 1270lm	W4 = 1320lm

577-01202:023XXY	W2	L: 857mm
577-01202:029XXY	W3	L: 857mm
577-01202:024XXY	W4	L: 857mm

### SYS 19W

1. W2 = 1650lm	W3 = 1790lm	W4 = 1860lm
2. W2 = 1850lm	W3 = 2020lm	W4 = 2100lm
3. W2 = 1560lm	W3 = 1700lm	W4 = 1770lm

577-01203:023XXY	W2	L: 1137mm
577-01203:029XXY	W3	L: 1137mm
577-01203:024XXY	W4	L: 1137mm

### SYS 24W

1. W2 = 2060lm	W3 = 2240lm	W4 = 2330lm
2. W2 = 2320lm	W3 = 2520lm	W4 = 2620lm
3. W2 = 1950lm	W3 = 2120lm	W4 = 2210lm

577-01204:023XXY	W2	L: 1417mm
577-01204:029XXY	W3	L: 1417mm
577-01204:024XXY	W4	L: 1417mm

### SYS 48W

1. W2 = 4130lm	W3 = 4490lm	W4 = 4670lm
2. W2 = 4640lm	W3 = 5050lm	W4 = 5250lm
3. W2 = 3910lm	W3 = 4250lm	W4 = 4420lm

577-01205:023XXY	W2	L: 2817mm
577-01205:029XXY	W3	L: 2817mm
577-01205:024XXY	W4	L: 2817mm

### SYS 71W

1. W2 = 6190lm	W3 = 6730lm	W4 = 7000lm
2. W2 = 6970lm	W3 = 7570lm	W4 = 7870lm
3. W2 = 5870lm	W3 = 6380lm	W4 = 6640lm

577-01206:023XXY	W2	L: 4217mm
577-01206:029XXY	W3	L: 4217mm
577-01206:024XXY	W4	L: 4217mm

LED Lichtprofil aus stranggepresstem Aluminium  
Oberfläche eloxiert, weiß oder schwarz pulverbeschichtet  
LED Konverter im Leuchtenprofil integriert  
Für Montage als Hängeleuchte  
Flache oder vorspringende kubische Abdeckung

Extruded aluminium LED profile  
Anodised, white or black powder coated finish  
Built-in LED converter in profile  
For ceiling mount  
Flat or cubic diffuser

Profilo in alluminio pressofuso a LED  
Finitura anodizzata, verniciatura a polveri bianca o nero  
Converter LED integrato nel profilo  
Per installazione a parete  
Diffusore piatto o cubico

Profil en aluminium pressé de LED  
Finis anodisé, vernissage à poudres blanc ou noir  
Convertisseur intégré dans le profil  
Pour installation à plafond  
Diffuseur plat ou cubique

W2 = LED 2700K  
W3 = LED 3000K  
W4 = LED 4000K

A++ - A

IP 20 CE

## ARTIKELNUMMER ERGÄNZEN / COMPLETE CODE

C = ABDECKUNG / COVER

XX = FARBE / COLOUR

Y = DIMMBAR / DIMMABLE

PMMA opal diffuser flat = 1

W white = 05

S switchable = 0

PMMA opal diffuser cubic = 2

S black = 06

D DALI dimm = d

Microprismatic cover flat = 3

AE aluminium anodized = 08



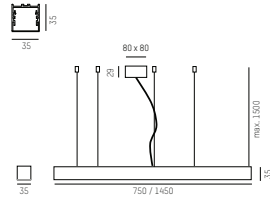

LED Ringleuchte aus stranggepresstem Aluminium  
 Oberfläche eloxiert, weiß oder schwarz pulverbeschichtet  
 LED Konverter im Leuchtenprofil integriert  
 Inkl. flache PMMA-Abdeckung

LED ring luminaire, extruded aluminium  
 Anodised surface, white or black powder-coated  
 Built-in LED converter in profile  
 Incl. flat PMMA diffuser

Lampada in alluminio estruso a forma di anello  
 Superficie anodizzata o verniciata a polvere in bianco o nero  
 Converter LED integrato nel profilo  
 Incl. copertura piatta in PMMA

Lampe en forme d'anneau en aluminium extrudé  
 Finition anodisée ou laquée blanc ou noir  
 Convertisseur intégré dans le profil  
 Incl. couvercle plat en PMMA

W2 = LED 2700K  
 W3 = LED 3000K  
 W4 = LED 4000K



IP 20

#### RIDE RING PD

220-240V AC/DC - CRI >90 - Binning SDCM 3 - DALI dimm.

SYS 38W / Ø 750mm	lm W2	lm W3	lm W4
675-20101102WXXd	3300	3590	3730

SYS 76W / Ø 1450mm	lm W2	lm W3	lm W4
675-20201102WXXd	6610	7180	7470

#### ARTIKELNUMMER ERGÄNZEN / COMPLETE CODE

W = LICHTFARBE/LIGHT COLOUR

XX = FARBE/COLOUR

W2 LED 2700K = 3  
 W3 LED 3000K = 9  
 W4 LED 4000K = 4

W white = 05  
 S black = 06  
 AE aluminium anodized = 08

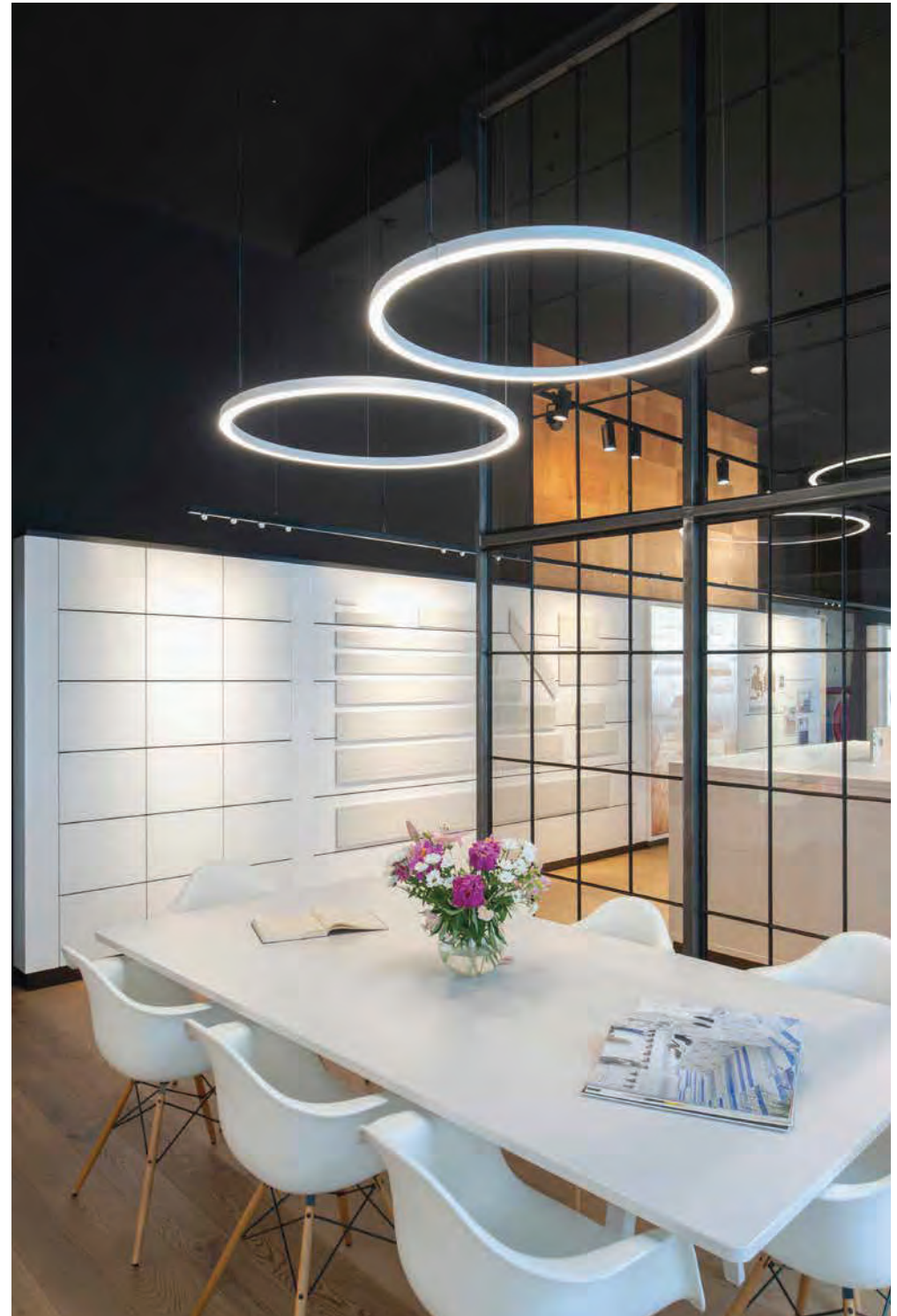

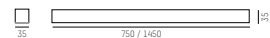
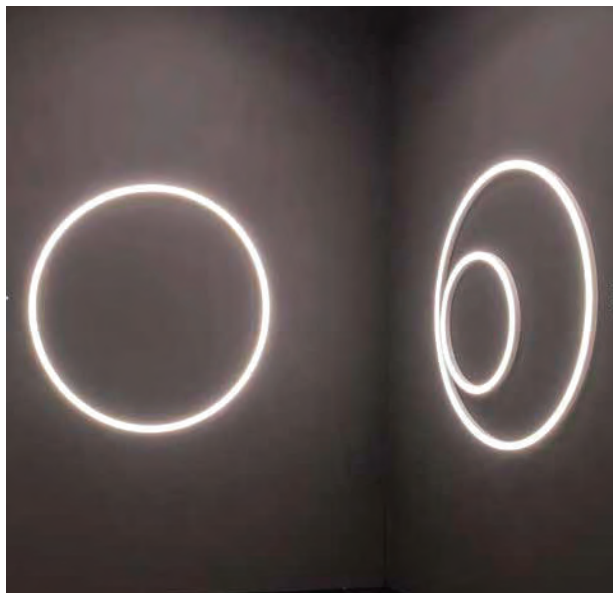

LED Ringleuchte aus stranggepresstem Aluminium  
 Oberfläche eloxiert, weiß oder schwarz pulverbeschichtet  
 LED Konverter im Leuchtenprofil integriert  
 Für Decken- und Wandmontage geeignet  
 Inkl. flache PMMA-Abdeckung

LED ring luminaire, extruded aluminium  
 Anodised surface, white or black powder-coated  
 Built-in LED converter in profile  
 suitable for wall and ceiling installation  
 Incl. flat PMMA diffuser

Lampada in alluminio estruso a forma di anello  
 Superficie anodizzata o verniciata a polvere in bianco o nero  
 Converter LED integrato nel profilo  
 Adatta per il montaggio a parete o a soffitto  
 Incl. copertura piatta in PMMA

Lampe en forme d'anneau en aluminium extrudé  
 Finition anodisée ou laquée blanc ou noir  
 Convertisseur intégré dans le profil  
 Incl. couvercle plat en PMMA

W2 = LED 2700K  
 W3 = LED 3000K  
 W4 = LED 4000K

A++ - A

IP20 © CE

#### RIDE RING SD

220-240V AC/DC · CRI >90 · Binning SDCM 3 · DALI dimm.

SYS 38W / Ø 750mm	lm W2	lm W3	lm W4
675-10101102WXXd	3300	3590	3730

SYS 76W / Ø 1450mm	lm W2	lm W3	lm W4
675-10201102WXXd	6610	7180	7470

#### ARTIKELNUMMER ERGÄNZEN / COMPLETE CODE

W = LICHTFARBE/LIGHT COLOUR

XX = FARBE/COLOUR

W2 LED 2700K = 3  
 W3 LED 3000K = 9  
 W4 LED 4000K = 4

W white = 05  
 S black = 06  
 AE aluminium anodized = 08



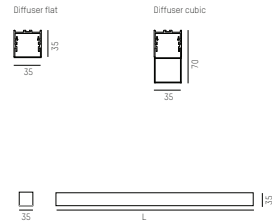

### RIDE SD

220-240V AC/DC · CRI >90 · Binning SDCM 3

#### SYS 10W (nicht dimmbar/not dimmable)

1. W2 = 820lm	W3 = 890lm	W4 = 930lm
2. W2 = 920lm	W3 = 1010lm	W4 = 1050lm
3. W2 = 780lm	W3 = 850lm	W4 = 880lm

577-01001C023XX0	W2	L: 577mm
577-01001C029XX0	W3	L: 577mm
577-01001C024XX0	W4	L: 577mm

#### SYS 15W

1. W2 = 1230lm	W3 = 1340lm	W4 = 1400lm
2. W2 = 1390lm	W3 = 1510lm	W4 = 1570lm
3. W2 = 1170lm	W3 = 1270lm	W4 = 1320lm

577-01002C023XXY	W2	L: 857mm
577-01002C029XXY	W3	L: 857mm
577-01002C024XXY	W4	L: 857mm

#### SYS 19W

1. W2 = 1650lm	W3 = 1790lm	W4 = 1860lm
2. W2 = 1850lm	W3 = 2020lm	W4 = 2100lm
3. W2 = 1580lm	W3 = 1700lm	W4 = 1770lm

577-01003C023XXY	W2	L: 1137mm
577-01003C029XXY	W3	L: 1137mm
577-01003C024XXY	W4	L: 1137mm

#### SYS 24W

1. W2 = 2060lm	W3 = 2240lm	W4 = 2330lm
2. W2 = 2320lm	W3 = 2520lm	W4 = 2620lm
3. W2 = 1850lm	W3 = 2120lm	W4 = 2210lm

577-01004C023XXY	W2	L: 1417mm
577-01004C029XXY	W3	L: 1417mm
577-01004C024XXY	W4	L: 1417mm

#### SYS 46W

1. W2 = 4130lm	W3 = 4490lm	W4 = 4670lm
2. W2 = 4640lm	W3 = 5050lm	W4 = 5250lm
3. W2 = 3910lm	W3 = 4250lm	W4 = 4420lm

577-01005C023XXY	W2	L: 2817mm
577-01005C029XXY	W3	L: 2817mm
577-01005C024XXY	W4	L: 2817mm

#### SYS 78W

1. W2 = 6190lm	W3 = 6730lm	W4 = 7000lm
2. W2 = 6970lm	W3 = 7570lm	W4 = 7870lm
3. W2 = 5870lm	W3 = 6380lm	W4 = 6640lm

577-01006C023XXY	W2	L: 4217mm
577-01006C029XXY	W3	L: 4217mm
577-01006C024XXY	W4	L: 4217mm

LED Lichtprofil aus stranggepresstem Aluminium  
Oberfläche eloxiert, weiß oder schwarz pulverbeschichtet  
LED Konverter im Leuchtenprofil integriert  
Für Decken- und Wandmontage geeignet  
Flache oder vorspringende kubische Abdeckung

Extruded aluminium LED profile  
Anodised, white or black powder coated finish  
Built-in LED converter in profile  
For ceiling and wall mount  
Flat or cubic diffuser

Profilo in alluminio pressofuso a LED  
Finitura anodizzata, verniciatura a polveri bianca o nera  
Converter LED integrato nel profilo  
Per installazione a soffitto e a parete  
Diffusore piatto o cubico

Profil en aluminium pressé de LED  
Finis anodisé, vernissage à poudres blanc ou noir  
Convertisseur intégré dans le profil  
Pour installation à plafond ou paroi  
Diffuseur plat ou cubique

W2 = LED 2700K  
W3 = LED 3000K  
W4 = LED 4000K

A++ - A

IP 20 CE

#### ARTIKELNUMMER ERGÄNZEN / COMPLETE CODE

C = ABDECKUNG / COVER

XX = FARBE / COLOUR

Y = DIMMBAR / DIMMABLE

PMMA opal diffuser flat = 1

W white = 05

S switchable = 0

PMMA opal diffuser cubic = 2

S black = 06

D DALI dimm = d

Micropismatic cover flat = 3

AE aluminium anodized = 08

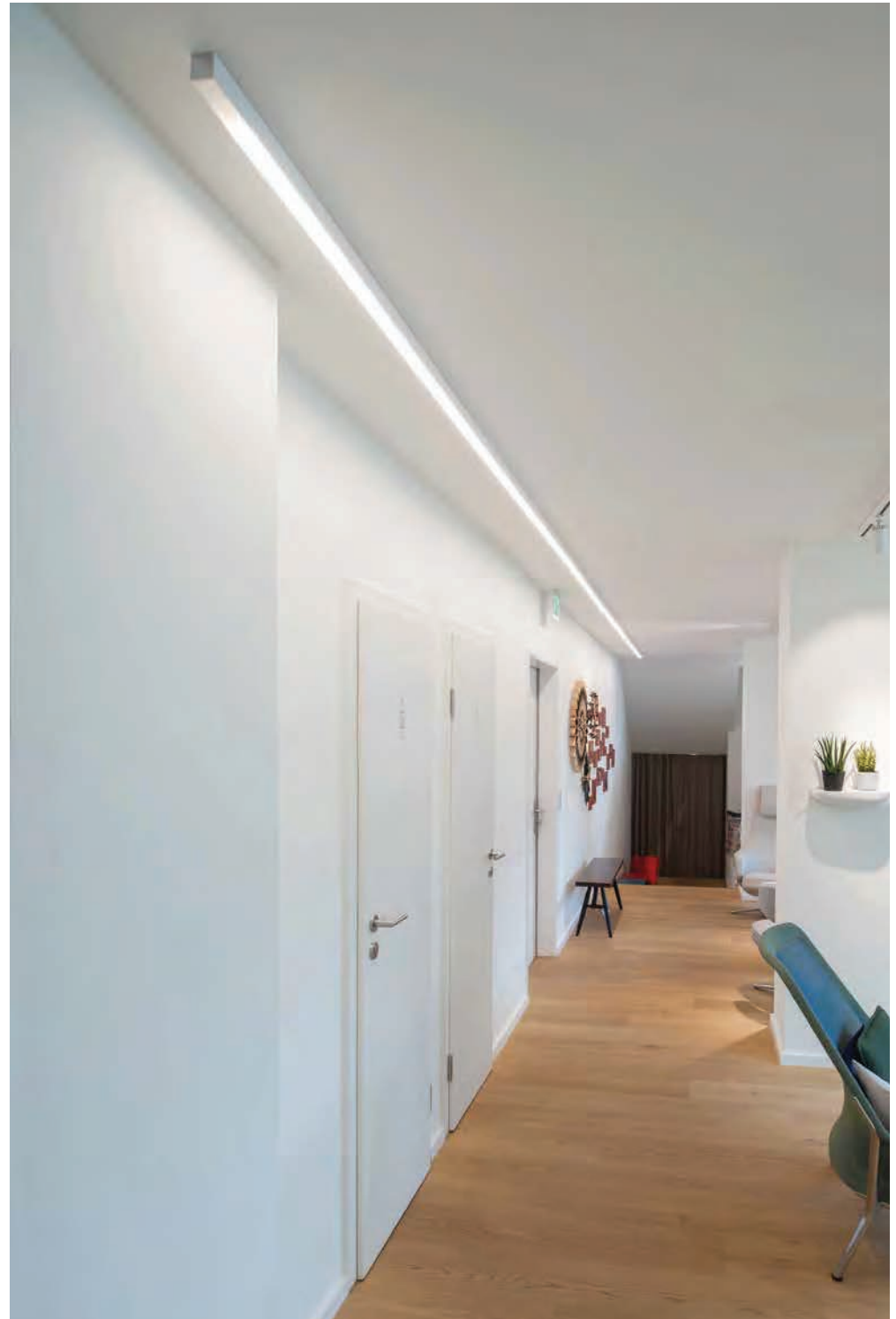

# RIDE SYSTEM

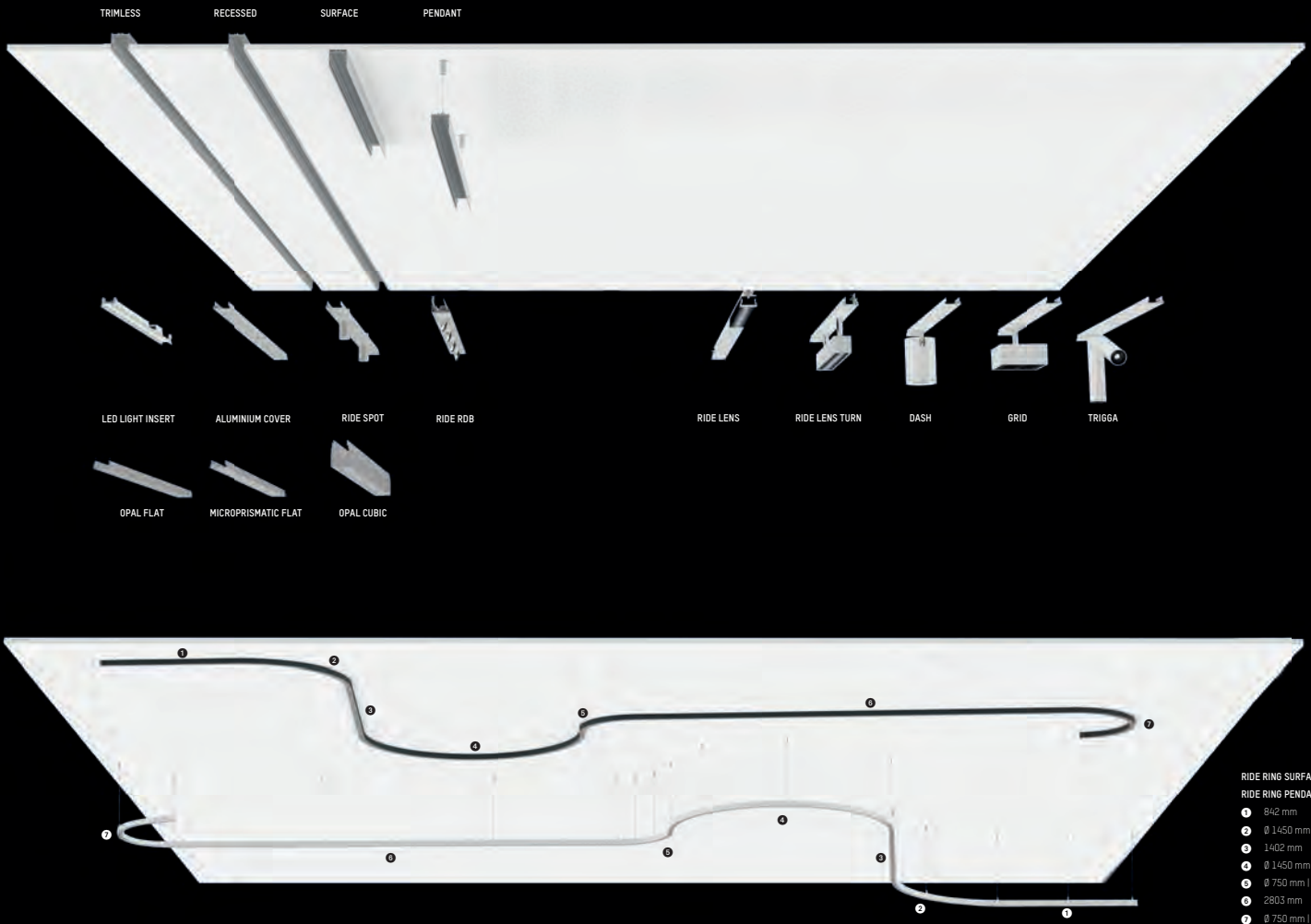

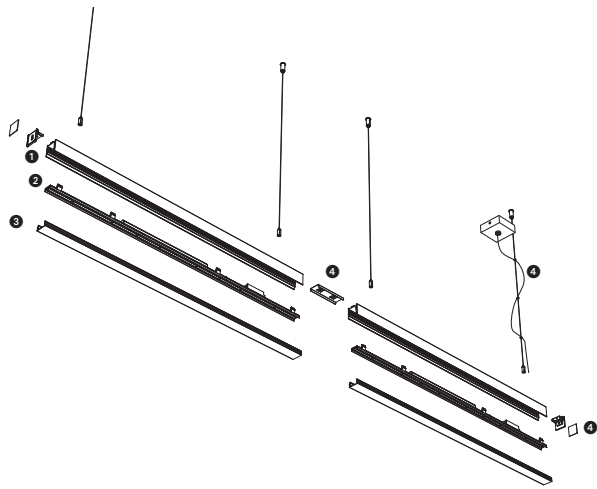

### 1. PROFILES

PROFILE SYSTEM SURFACE

PROFILE SYSTEM RECESSED

PROFILE SYSTEM RECESSED TRIMLESS

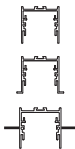

INFO: BETONEINBAU AUF ANFRAGE  
INFO: CONCRETE MOUNTING ON REQUEST

### 2. INSERTS

LIGHT INSERTS LED

LIGHT INSERTS SPOTS

LIGHT INSERTS ROB

LIGHT INSERTS LENS

LIGHT INSERTS LENS TURN

LIGHT INSERTS DASH

LIGHT INSERTS GRID

LIGHT INSERTS TRIGGA

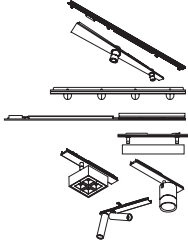

### 3. COVERS

PMMA COVER OPAL FLAT



PMMA COVER OPAL CUBIC



MICROPRISMATIC COVER FLAT



### 4. COMPONENTS

SUSPENSION

POWER FEED

END PIECE FLAT

END PIECE CUBIC

90° JUNCTION HORIZONTAL

90° JUNCTION VERTICAL

LINEAR JUNCTION

MOUNTING BRACKETS

EARTHING SET

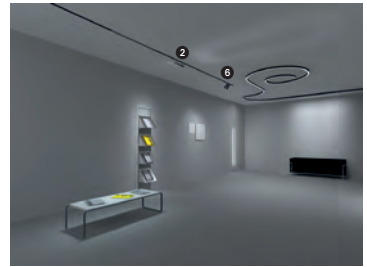
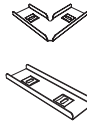

RIDE LENS INSERT



RIDE LENS TURN INSERT



ROB LIGHT INSERT



DASH LIGHT INSERT



GRID LIGHT INSERT



TRIGGA LIGHT INSERT



RIDE SPOT INSERT



RIDE CUBIC COVER



RIDE FLAT COVER



RIDE CURVED

LED Lichtprofil aus stranggepresstem Aluminium  
 Oberfläche eloxiert, weiß oder schwarz pulverbeschichtet  
 Montage als Einbau, Aufbau oder abgehängte Version  
 Fläche oder vorspringende kubische Abdeckung

Extruded aluminium LED profile  
 Anodised, white or black powder coated finish  
 Recessed, surface or pendant mounting  
 Flat or cubic diffuser

Profilo in alluminio pressofuso a LED  
 Finitura anodizzata, verniciatura a polveri bianca o nera  
 Montaggio ad incasso, superficie o sospeso  
 Diffusore piatto o cubico

Profil en aluminium presse' de LED  
 Finitis anodis , vernissage   poudres blanc ou noir  
 Encastr , plafonnier ou suspension  
 Diffuseur plat ou cubique

Die Schutzart IP54 wird nur bei Deckenmontage des  
 Leuchtensystems gew hrlistet  
 IP54 protection applies for ceiling installation only

Achtung:  
 Max. zul ssige, durchgehende Systeml nge pro Ein-  
 speisung betr gt 15m (max. 400W!)  
 Die Durchgangsverdrahtung entspricht einem Quer-  
 schnitt von 0,75mm!)

Attention:  
 System lenght per feed maximal 15m (max. 400W!)  
 The cross section of the trough wiring is 0,75mm!)

A - A

IP 20 CE

## PROFILES

### AUFBAUPROFIL SYSTEM / SURFACE PROFILE SYSTEM

Abdeckungen, Lichteins tze und Zubeh r separat ordern, max. Profill nge: 4400mm  
 order covers, light inserts and components separately, max. profile length: 4400mm  
**IP54: maximale lineare L nge: 4400mm / maximal linear length: 4400mm**

577-410XX L: 4500mm



### EinBAUPROFIL SYSTEM / RECESSED PROFILE SYSTEM

Abdeckungen, Lichteins tze und Zubeh r separat ordern, max. Profill nge: 4400mm  
 order covers, light inserts and components separately, max. profile length: 4400mm  
**IP54: maximale lineare L nge: 4400mm / maximal linear length: 4400mm**  
**IP54: Einbauversion nur mit flacher Abdeckung m glich / Recessed version only with flat cover**

577-411XX L: 4500mm



### EinBAUPROFIL RAHMENLOS SYSTEM / RECESSED PROFILE TRIMLESS SYSTEM

Abdeckungen, Lichteins tze und Zubeh r separat ordern, max. Profill nge: 4400mm  
 order covers, light inserts and components separately, max. profile length: 4400mm  
**IP54: maximale lineare L nge: 4400mm / maximal linear length: 4400mm**  
**IP54: Einbauversion nur mit flacher Abdeckung m glich / Recessed version only with flat cover**

577-320leer L: 2000mm  
 577-41200 L: 4500mm



## COVERS

### PMMA ABDECKUNG OPAL FLACH / PMMA COVER OPAL FLAT

577-42100 L: 4500mm



### PMMA ABDECKUNG OPAL KUBISCH / PMMA COVER OPAL CUBIC

577-42200 L: 4500mm



### MIKROPRISMENABDECKUNG FLACH / MICROPRISMATIC COVER

577-42300 L: 4500mm



### ALUMINIUMABDECKUNG FLACH / ALUMINIUM COVER FLAT

577-485XX L: 4500mm



## ARTIKELNUMMER ERG NZEN / COMPLETE CODE

XX = FARBE / COLOUR

white = 05  
 black = 06  
 aluminium anodized = 08



**SYSTEM COMPONENTS**

**RIDE SYSTEM + RIDE RING SYSTEM ABHÄNGUNG HÖHENVERSTELLBAR / SUSPENSION ADJUSTABLE IN HEIGHT**

H: max. 1500mm; Abstand max. 1500mm / distance max. 1500mm

577-4905 577-4906 577-4904



**RIDE SYSTEM + RIDE RING SYSTEM EINSPEISUNG / POWER FEED**

H: max. 1500mm; 5 x 0,75mm<sup>2</sup>

577-4805 577-4806 577-4804

H: max. 1500mm; 5 x 0,75mm<sup>2</sup>; für dimm. / for dimm.

577-4815 577-4816 577-4814



**RIDE SYSTEM + RIDE RING SYSTEM ENDECKEL FLACH AUFBAU / END PIECE FLAT SURFACE**

IP 20 oder IP54 Installationen, Set 2 Stk. / IP20 or IP54 installation, set 2 pcs.

577-4605 577-4606 577-4604

577-4615 IP54 577-4616 IP54 577-4614 IP54



**RIDE SYSTEM ENDECKEL KUBISCH AUFBAU / END PIECE CUBIC SURFACE**

IP 20 oder IP54 Installationen, Set 2 Stk. / IP20 or IP54 installation, set 2 pcs.

577-4625 577-4626 577-4624

577-4635 IP54 577-4636 IP54 577-4634 IP54



**RIDE SYSTEM ENDECKEL FLACH EINBAU / END PIECE FLAT RECESSED**

IP 20 oder IP54 Installationen, Set 2 Stk. / IP20 or IP54 installation, set 2 pcs.

577-4705 577-4706 577-4704

577-4715 IP54 577-4716 IP54 577-4714 IP54



**RIDE SYSTEM ENDECKEL EINBAU RAHMENLOS / END PIECE RECESSED TRIMLESS**

IP 20 Installationen, Set 2 Stk. / IP20 installation, set 2 pcs.

577-4720



**RIDE SYSTEM ENDECKEL FÜR BETONEINBAU / END PIECE FOR CONCRETE**

IP 20 Installationen, Set 2 Stk. / IP20 installation, set 2 pcs.

577-4648



**RIDE SYSTEM BETONEINBAU HALTEBÜGEL / HOLDER FOR CONCRETE**

Je Meter 1 Bügel, mindestens 3 Stk. pro Profil erforderlich / Order 1 holder per meter, min 3 pcs. needed per profile

577-5100



**SYSTEM COMPONENTS**

**RIDE SYSTEM 90° ECKVERBINDER / 90° JUNCTION**

Horizontale oder vertikale Installationen, **NUR IP20 GEEIGNET** / horizontal or vertical mounting, **FOR IP20 ONLY**

577-4400 Horizontal / horizontal

577-4410 Vertikal / vertical



**RIDE SYSTEM LINEARVERBINDER INNENLIEGEND / LINEAR JUNCTION IN BOARD**

Innenliegend, **NUR IP20 GEEIGNET** / in board, **FOR IP20 ONLY**

577-4300



**RIDE SYSTEM LINEARVERBINDER INNENLIEGEND FÜR RIDE LENS / LINEAR JUNCTION IN BOARD FOR RIDE LENS**

Innenliegend, **NUR IP20 GEEIGNET** / in board, **FOR IP20 ONLY**

614-420



**RIDE RING SYSTEM VERBINDER INNENLIEGEND / LINEAR JUNCTION IN BOARD**

Innenliegend, **NUR IP20 GEEIGNET** / in board, **FOR IP20 ONLY**

- 675-4210000000000 C-SHAPE 750 - 750
- 675-4220000000000 C-SHAPE 750 - 1450
- 675-4230000000000 C-SHAPE 1450 - 1450
- 675-4240000000000 S-SHAPE 750 - 750
- 675-4250000000000 S-SHAPE 750 - 1450
- 675-4260000000000 S-SHAPE 1450 - 1450
- 675-4270000000000 LINEAR - CURVE 750
- 675-4280000000000 LINEAR - CURVE 1450



**RIDE SYSTEM MONTAGESSET FÜR WAND- / DECKEINBAU / SET FOR WALL- / CEILING RECESSED MOUNTING**

Je Meter 1 Bügel, mindestens 3 Stk. pro Profil erforderlich / Order 1 holder per meter, min 3 pcs. needed per profile

577-5000



**RIDE SYSTEM ERDUNGSSET / EARTHING SET**

577-2000





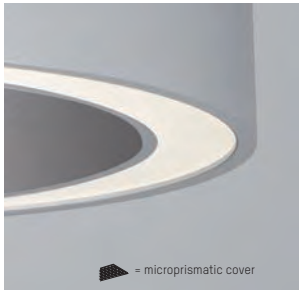

☞ = opal cover

▴ = microprismatic cover

### RING PDI

220-240V AC - CRI >80 - Binning SDCM 3  
direct / indirect beam

#### SYS 148W

445-92120131XY Ø 1200 - H 100 / 13675lm  
445-92120191XY Ø 1200 - H 100 / 14297lm  
445-92120141XY Ø 1200 - H 100 / 15540lm

445-92120132XY Ø 1200 - H 100 / 13197lm  
445-92120192XY Ø 1200 - H 100 / 13796lm  
445-92120142XY Ø 1200 - H 100 / 14996lm

#### SYS 196W

445-92150131XY Ø 1500 - H 100 / 18234lm  
445-92150191XY Ø 1500 - H 100 / 19062lm  
445-92150141XY Ø 1500 - H 100 / 20720lm

445-92150132XY Ø 1500 - H 100 / 17595lm  
445-92150192XY Ø 1500 - H 100 / 18395lm  
445-92150142XY Ø 1500 - H 100 / 19995lm

#### SYS 390W

445-92300131XY Ø 3000 - H 100 / 36432lm  
445-92300191XY Ø 3000 - H 100 / 38088lm  
445-92300141XY Ø 3000 - H 100 / 41400lm

445-92300132XY Ø 3000 - H 100 / 35157lm  
445-92300192XY Ø 3000 - H 100 / 36755lm  
445-92300142XY Ø 3000 - H 100 / 39951lm

#### SYS 781W

445-92600131XY Ø 6000 - H 100 / 72908lm  
445-92600191XY Ø 6000 - H 100 / 76222lm  
445-92600141XY Ø 6000 - H 100 / 82850lm

445-92600132XY Ø 6000 - H 100 / 70356lm  
445-92600192XY Ø 6000 - H 100 / 73554lm  
445-92600142XY Ø 6000 - H 100 / 79950lm

### RING PD

220-240V AC - CRI >80 - Binning SDCM 3  
direct beam

#### SYS 86W

445-90120131XY Ø 1200 - H 80 / 7128lm  
445-90120191XY Ø 1200 - H 80 / 7452lm  
445-90120141XY Ø 1200 - H 80 / 8100lm

445-90120132XY Ø 1200 - H 80 / 6551lm  
445-90120192XY Ø 1200 - H 80 / 6848lm  
445-90120142XY Ø 1200 - H 80 / 7444lm

#### SYS 114W

445-90150131XY Ø 1500 - H 80 / 9504lm  
445-90150191XY Ø 1500 - H 80 / 9936lm  
445-90150141XY Ø 1500 - H 80 / 10800lm

445-90150132XY Ø 1500 - H 80 / 8734lm  
445-90150192XY Ø 1500 - H 80 / 9131lm  
445-90150142XY Ø 1500 - H 80 / 9925lm

#### SYS 226W

445-90300131XY Ø 3000 - H 80 / 18920lm  
445-90300191XY Ø 3000 - H 80 / 19780lm  
445-90300141XY Ø 3000 - H 80 / 21500lm

445-90300132XY Ø 3000 - H 80 / 17387lm  
445-90300192XY Ø 3000 - H 80 / 18178lm  
445-90300142XY Ø 3000 - H 80 / 19759lm

#### SYS 453W

445-90600131XY Ø 6000 - H 80 / 37928lm  
445-90600191XY Ø 6000 - H 80 / 39652lm  
445-90600141XY Ø 6000 - H 80 / 43100lm

445-90600132XY Ø 6000 - H 80 / 34856lm  
445-90600192XY Ø 6000 - H 80 / 36440lm  
445-90600142XY Ø 6000 - H 80 / 39609lm

Ringleuchte aus Aluminium  
In weiß, schwarz oder silber pulverbeschichtet oder in champagne lackiert  
Abdeckung als Opal-Diffusor oder mit Mikroprismenoptik  
Nicht angeführte Durchmesser auf Anfrage erhältlich

Ring luminaire in aluminium  
Black, white or silver powder-coated or champagne painted  
Opal or microprismatic diffuser  
Not listed diameters available on request

Lampada in alluminio a forma di anello  
Verniciata a polvere in nero, bianco, grigio o champagne laccato  
Diffusore opale o microprismatico  
Diametri non elencati disponibili su richiesta

Luminaire en forme d'anneau en aluminium  
Vernissage à poudre en gris, blanc ou noir ou champagne laqué  
Diffuseur opal ou à microprismes  
Diamètres non listés disponibles sur demande

▴ = UGR < 19

= LED 2700K  
 = LED 3000K  
 = LED 4000K

CRI >90 Versionen auf Anfrage  
CRI >90 versions on request

A++ - A

IP 20

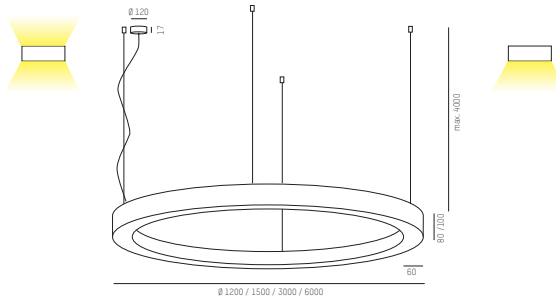

### ARTIKELNUMMER ERGÄNZEN / COMPLETE CODE

X = FARBE/COLOUR

Y = DIMMBAR/DIMMABLE

champagne matt = 3  
 white = 5  
 black = 6  
 silver matt = 8

switchable = 0  
 DALI dimm = d





☞ = opal cover

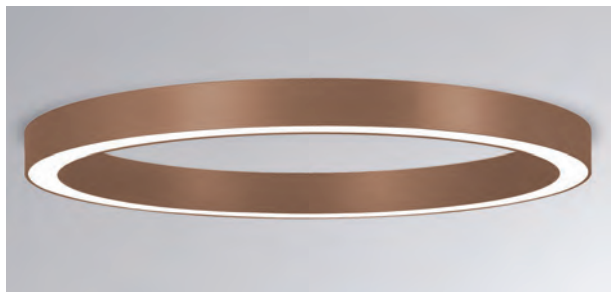

☛ = microprismatic cover



### RINQ SD

220-240V AC - CRI >80 - Binning SDCM 3  
direct beam

#### SYS 86W

445-91120131XY ☞2 Ø 1200 / 7128lm  
445-91120191XY ☞3 Ø 1200 / 7452lm  
445-91120141XY ☞4 Ø 1200 / 8100lm

445-91120132XY ☞2 Ø 1200 / 6551lm  
445-91120192XY ☞3 Ø 1200 / 6848lm  
445-91120142XY ☞4 Ø 1200 / 7444lm

#### SYS 114W

445-91150131XY ☞2 Ø 1500 / 9504lm  
445-91150191XY ☞3 Ø 1500 / 9936lm  
445-91150141XY ☞4 Ø 1500 / 10800lm

445-91150132XY ☞2 Ø 1500 / 8734lm  
445-91150192XY ☞3 Ø 1500 / 9131lm  
445-91150142XY ☞4 Ø 1500 / 9925lm

#### SYS 226W

445-91300131XY ☞2 Ø 3000 / 18920lm  
445-91300191XY ☞3 Ø 3000 / 19780lm  
445-91300141XY ☞4 Ø 3000 / 21500lm

445-91300132XY ☞2 Ø 3000 / 17387lm  
445-91300192XY ☞3 Ø 3000 / 18178lm  
445-91300142XY ☞4 Ø 3000 / 19759lm

#### SYS 453W

445-91600131XY ☞2 Ø 6000 / 37928lm  
445-91600191XY ☞3 Ø 6000 / 39652lm  
445-91600141XY ☞4 Ø 6000 / 43100lm

445-91600132XY ☞2 Ø 6000 / 34856lm  
445-91600192XY ☞3 Ø 6000 / 36440lm  
445-91600142XY ☞4 Ø 6000 / 39609lm

Ringleuchte aus Aluminium  
In weiß, schwarz oder silber pulverbeschichtet oder in champagner lackiert  
Abdeckung als Opal-Diffusor oder mit Mikroprismenoptik  
Nicht angeführte Durchmesser auf Anfrage erhältlich

Ring luminaire in aluminium  
Black, white or silver powder-coated or champagne painted  
Opal or microprismatic diffuser  
Not listed diameters available on request

Lampada in alluminio a forma di anello  
Verniciata a polvere in nero, bianco, grigio o champagne laccato  
Diffusore opale o microprismatico  
Diametri non elencati disponibili su richiesta

Luminaire en forme d'anneau en aluminium  
Vernissage à poudres gris, blanc ou noir ou champagne laqué  
Diffuseur opal ou à microprismes  
Diamètres non listés disponibles sur demande

☛ = UGR<19

☞2 = LED 2700K  
☞3 = LED 3000K  
☞4 = LED 4000K

CRI >90 Versionen auf Anfrage  
CRI >90 versions on request

A++ - A

IP 20 CE

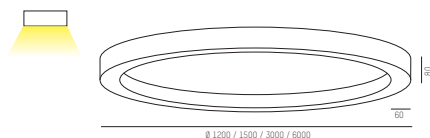

#### ARTIKELNUMMER ERGÄNZEN / COMPLETE CODE

X = FARBE/COLOUR

Y = DIMMBAR/DIMMABLE

☞ champagne matt = 3  
☞ white = 5  
☞ black = 6  
☞ silver matt = 8

☉ switchable = 0  
☉ DALI dimm = d





LED Aufbaustrahler aus Aluminium  
 Oberfläche in weiß oder schwarz pulverbeschichtet  
 Zurückversetzte Linse mit verschiedenen Abstrahlwinkeln  
 Lichtaustrittsfläche von nur 10 mm  
 Perfekte Entblendung und erhöhter Sehkomfort

LED spotlight in aluminium  
 White or black finish powder coated  
 Recessed lenses with different beam-angles  
 light exit field with only 10 mm  
 Perfect glare control and increased visual comfort

Faretto a LED in alluminio  
 Verniciatura a polveri in bianco o nero  
 Lenti spostati indietro con varie emissioni  
 Dispositivo di eliminazione di soli 10 mm  
 Controllo anti-abbagliamento per un elevato comfort visivo

Spot à LED en aluminium  
 Vernissage ó poudres en blanc ou noir  
 Lentés déplacés au fond avec d'émissions différentes  
 Plus que 10 mm de surface d'émission de lumière  
 Control anti-éblouissement et confort visuel optimal

UGR<16

W2 = LED 2700K  
 W3 = LED 3000K



IP 20

LF0 Lens-Technology by Barthenbach

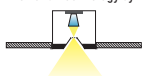

### TRIGGA 1 SD

220-240V AC - CRI >90 - Binning SDCM 3 - inkl. LED Konverter / incl. LED converter

SYS 11W

682-011040223XX0 380lm  
 682-011040229XX0 410lm

682-011040523XX0 440lm  
 682-011040529XX0 470lm

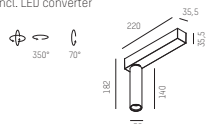

### TRIGGA 2 SD

220-240V AC - CRI >90 - Binning SDCM 3 - inkl. LED Konverter / incl. LED converter

SYS 15W

682-010050223XX0 610lm  
 682-010050229XX0 650lm

682-010050523XX0 710lm  
 682-010050529XX0 760lm

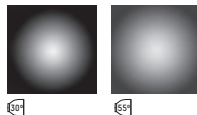
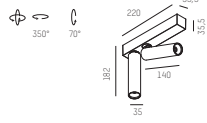

ARTIKELNUMMER ERGÄNZEN / COMPLETE CODE

XX = FARBE/COLOUR

W white = 55  
 S black = 66











### TRIGGA LOON MINI PD

220-240V AC · CRI >90 · Binning SDCM 3  
TRIGGA nur in schwarz erhältlich  
TRIGGA available in black only

SYS 6W

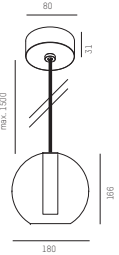

662-0170202236XX   230lm  
662-0170202296XX   250lm

662-0170205236XX   270lm  
662-0170205296XX   290lm



ARTIKELNUMMER ERGÄNZEN / COMPLETE CODE

X = FARBE/COLOUR GLASS

 black-amber = 7  
 black-brown = 8  
 black-grey = 9

LED Pendelleuchte aus Aluminium  
Bronze eloxiert, weiß oder schwarz pulverbeschichtet  
Zurückversetzte Linsen mit verschiedenen Abstrahlwinkeln  
Lichtaustrittsfläche von nur 10 mm  
Perfekte Entblendung und erhöhter Sehkomfort

LED pendant in aluminium  
Bronze anodized, white or black powder coated  
Recessed lenses with different beam-angles  
light exit field with only 10 mm  
Perfect glare control and increased visual comfort

Incasso LED in alluminio  
Bronzo anodizzato, verniciato a polvere in bianco o nero  
Lenti spostati indietro con varie emissioni  
Dispositivo di eliminazione di soli 10 mm  
Controllo anti-abbagliamento per un elevato comfort visivo

Encastré LED en aluminium  
Bronze anodisé, vernissé à poudre en blanc ou noir  
Lentilles déplacées au fond avec d'émissions différentes  
Plus que 10 mm de surface d'émission de lumière  
Control anti-éblouissement et confort visuel optimal

UGR<16

 = LED 2700K  
 = LED 3000K

 - 

IP 20 

LF0 Lens-Technology by Barthenbach

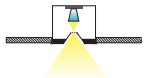

### TRIGGA SHORT PD

220-240V AC · CRI >90 · Binning SDCM 3  
inkl. LED Konverter / incl. LED converter

SYS 6W

662-004020223XX   230lm H: 140mm  
662-004020229XX   250lm H: 140mm

662-004020523XX   270lm H: 140mm  
662-004020529XX   290lm H: 140mm

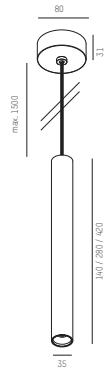

### TRIGGA LONG PD

220-240V AC · CRI >90 · Binning SDCM 3  
inkl. LED Konverter / incl. LED converter

SYS 6W

662-005020223XX   230lm H: 280mm  
662-005020229XX   250lm H: 280mm

662-005020523XX   270lm H: 280mm  
662-005020529XX   290lm H: 280mm

### TRIGGA XL PD

220-240V AC · CRI >90 · Binning SDCM 3  
inkl. LED Konverter / incl. LED converter



SYS 6W

662-021020223XX   230lm H: 420mm  
662-021020229XX   250lm H: 420mm

662-021020523XX   270lm H: 420mm  
662-021020529XX   290lm H: 420mm

ARTIKELNUMMER ERGÄNZEN / COMPLETE CODE

XX = FARBE/COLOUR

 white = 55  
 black = 66  
 bronze anodized = 62





TRIGGA mit Einbaurahmen  
TRIGGA with recessed frame

LED Halbeinbauspot aus Aluminium  
Oberfläche in weiß oder schwarz  
Zurückversetzte Linse mit verschiedenen Abstrahlwinkeln  
Lichtaustrittsfläche von nur 10 mm  
Perfekte Entblendung und erhöhter Sehkomfort

Semi recessed LED spotlight in aluminium  
White or black finish  
Recessed lenses with different beam-angles  
light exit field with only 10 mm  
Perfect glare control and increased visual comfort

Semi incassé LED in aluminium  
Finitura in bianco o nero  
Lenti spostati indietro con varie emissioni  
Dispositivo di diminuzione di soli 10 mm  
Controllo anti-abbagliamento per un elevato comfort visivo

Semi encastré LED en aluminium  
Vernissage blanc ou noir  
Lentilles déplacées au fond avec d'émissions différentes  
Plus que 10 mm de surface d'émission de lumière  
Control anti-éblouissement et confort visuel optimal

UGR<16

W2 = LED 2700K  
W3 = LED 3000K

A++ → A

IP 20

LF0 Lens-Technology by Barthenbach



### TRIGGA R

CRI >90 - Binning SDCM 3 - exkl. LED Konverter (separat ordern) / excl. LED converter (order separately)

LED 6W - 500mA

682-006020223XX0 300lm  
682-006020229XX0 320lm

682-006020523XX0 350lm  
682-006020529XX0 370lm



### LED-KONVERTER / LED CONVERTER

- 24-122448 14W / 500mA, not dimmable
- 24-151403 20W / 500mA, DALI dimm.

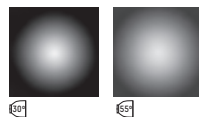
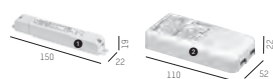

### ARTIKELNUMMER ERGÄNZEN / COMPLETE CODE

XX = FARBE/COLOUR

W white = 55  
S black = 66





TRIGGA rahmenlos mit Einbauring  
TRIGGA trimless with mounting ring

LED Halbeinbauspot aus Aluminium  
Oberfläche in weiß oder schwarz  
Zurückversetzte Linse mit verschiedenen Abstrahlwinkeln  
Lichtaustrittsfläche von nur 10 mm  
Perfekte Entblendung und erhöhter Sehkomfort

Semi recessed LED spotlight in aluminium  
White or black finish  
Recessed lenses with different beam-angles  
light exit field with only 10 mm  
Perfect glare control and increased visual comfort

Semi incassé LED in aluminium  
Finitura in bianco o nero  
Lenti spostati indietro con varie emissioni  
Dispositivo di eliminazione di soli 10 mm  
Controllo anti-abbagliamento per un elevato comfort visivo

Semi encastré LED en aluminium  
Vernissage blanc ou noir  
Lentilles déplacées au fond avec d'émissions différentes  
Plus que 10 mm de surface d'émission de lumière  
Control anti-éblouissement et confort visuel optimal

UGR<16

W2 = LED 2700K  
W3 = LED 3000K



IP 20

DESIGN PLUS  
powered by light+building

#### TRIGGA TRIMLESS R

CRI >90 - Binning SDCM 3 - excl. LED Konverter (separat ordern) / excl. LED converter (order separately)  
Einbauring und Werkzeug separat ordern / order mounting ring and tool separately

LED 6W - 500mA

682-007020223XX0 W2 50° 300lm  
682-007020229XX0 W3 50° 320lm

682-007020523XX0 W2 55° 350lm  
682-007020529XX0 W3 55° 370lm



#### EinBAURING / MOUNTING RING

640-000010 Einbauring / mounting ring

640-000020 Werkzeug zu Einbauring / Tool for mounting ring



#### LED-KONVERTER / LED CONVERTER

- 24-122448 14W / 500mA, not dimmable
- 24-151403 20W / 500mA, DALI dimm.

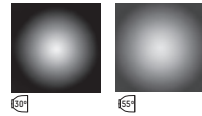
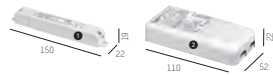

#### ARTIKELNUMMER ERGÄNZEN / COMPLETE CODE

XX = FARBE/COLOUR

W white = 55  
S black = 66

LFO Lens-Technology by Barthenbach

