

ThermalHEART™

THERMALLY BROKEN SYSTEMS FOR MAXIMUM EFFICIENCY & COMFORT

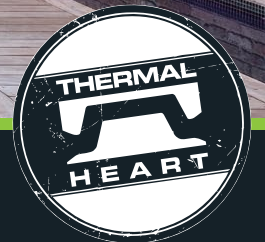
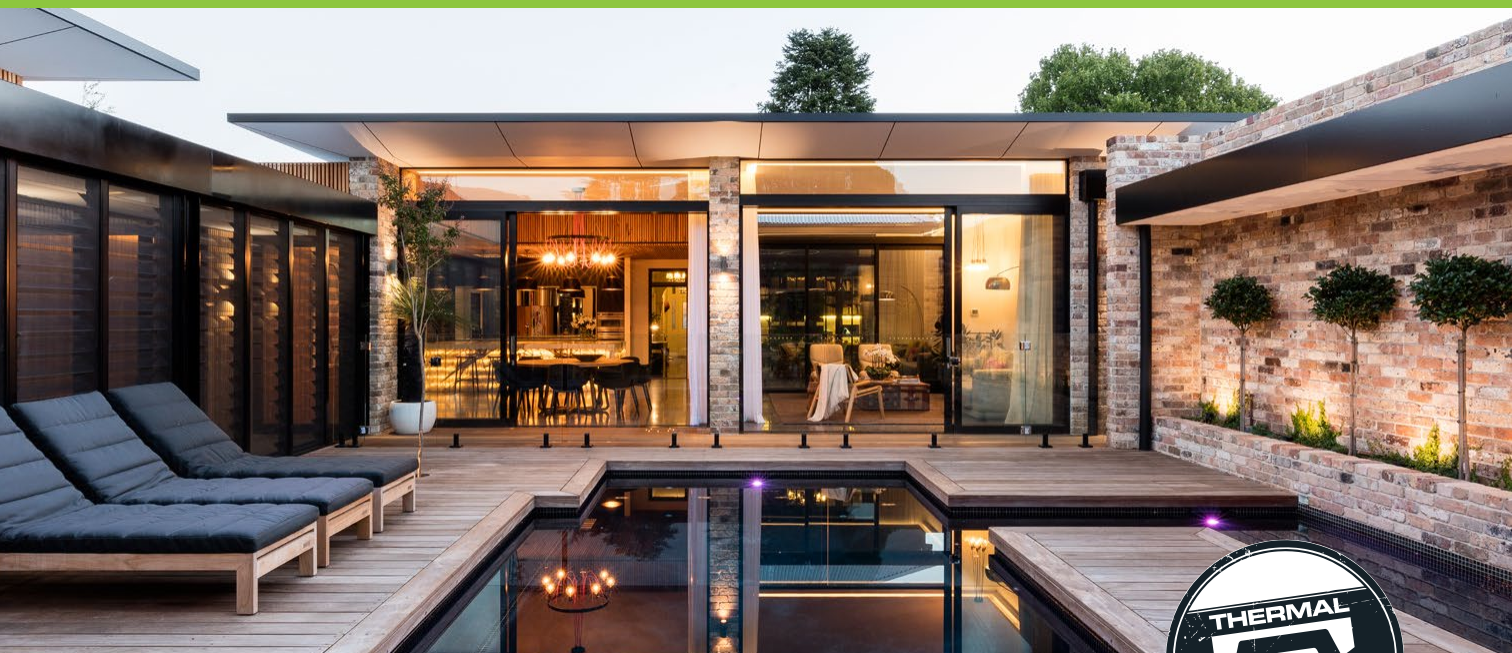

THERMALLY BROKEN SYSTEMS BY **DAWS**

It's time to start breaking your windows

Thermally breaking, that is.

ThermalHEART™ is the technology that lies at the core of AWS's thermally efficient range of residential and commercial aluminium window and door systems.

ThermalHEART™ window and door systems are thermally broken to deliver improved energy efficiency for buildings. In fact, ThermalHEART™ aluminium windows and doors are up to 51% more thermally efficient than standard non-thermally broken aluminium framing.

The thermal break in ThermalHEART™ windows and doors is created using a polyamide strip between the aluminium

exterior and interior elements. Polyamide is an excellent thermal insulator. The thermal break minimises the transfer of heat and cold through the aluminium window frame, giving the thermally broken aluminium window excellent insulation properties. Polyamide has very similar expansion rates to aluminium, ensuring ThermalHEART™ extrusions maintain excellent structural integrity.



Specifier Support

We are here to help, every step of the way.

At AWS, we are so committed to providing support to architects and specifiers, we've decided to take this whole page to tell you about it.

The road to creating a specification can be varied, and resources and approaches differ. That's why we offer you a variety of technical tools to make specifying AWS systems easy, including CAD and 3D files, extensive technical literature and an expert specification team.

We are intent on supporting industry professionals and contributing to knowledge and awareness around high-performance window and door systems.

We take pride in the relationships we have formed with both the architects, building designers and their associations around the country.

Our technical team is always happy to help.

Just email techsupport@awsaustralia.com.au for all the support you need.



Australian Institute of Architects
Supporting Corporate Partner





Understanding Our Systems

Residential and Commercial Systems.

Select the ideal window or door system for your project from our range of commercial and residential ThermalHEART™ systems.



DESIGNER SERIES | ThermalHEART™

Developed in response to growing environmental concern and requirement for energy efficient building designs, Designer Series with ThermalHeart™ offers significantly improved thermal performance and energy efficiency.

Ideal for residential applications where minimising cold and heat transfer is a priority, this innovative range is 32% more thermally efficient than standard double glazed windows and doors.

Residential Systems

- Series 726 Thermally Broken Awning Window
- Series 729 Thermally Broken Hinged Door
- Series 730 Thermally Broken Bi-fold Door
- Series 731 Thermally Broken Sliding Door



COMMERCIAL | ThermalHEART™

Australia's first range of high-performance, thermally broken commercial framing systems.

Designed to offer superior thermal performance and address the growing need for energy efficient systems in commercial applications. Elevate™ Commercial with ThermalHEART™ technology delivers drastically improved thermal performance to help architects and designers meet the increasingly stringent energy requirements for commercial buildings.

Commercial Systems

- Series 804 Thermally Broken CentreGLAZE™ (100mm)
- Series 806 Thermally Broken CentreGLAZE™ (150mm)
- Series 824 Thermally Broken FrontGLAZE™ (100mm)
- Series 826 Thermally Broken FrontGLAZE™ (150mm)
- Series 831 Thermally Broken Bi-Fold Door (Top Hung)
- Series 832 Thermally Broken Bi-Fold Door (Bottom Roiling)
- Series 852 Thermally Broken Commercial Doors

WAVERLEY HOUSE | ARCHITECT: SIMON ANDERSON, ANDERSON ARCHITECTURE | WINDOWS BY AVS WINDOWS



Contents

ThermalHEART™ Range

Innovative Features.

What's Inside	10
Thermal Performance	16
Section J Compliance	22
Design Flexibility	24
Achieving Comfort	26

Project Features

ThermalHEART™ in the Wild.

Kinghorn Motors Case Study	30
Flannery Centre Case Study	32
Rumney Rest	34
Dawes Residence	38

General Information

All the extra bits you'll want to know.

General Information	44
Colour Your World	46
Choosing the Right Glass	48
Hardware Solutions	50
Hardware Catalogue	51
Hardware Compatibility	55
Typical Configurations	56
Fabricator Network	58
Showrooms	60

Need help selecting your windows and doors? The AWS specifier team can help you develop your window and door specifications.

Contact us via email at techsupport@awsaustralia.com.au

ThermalHEART™ RANGE

Innovative Features.

10 - What's Inside

16 - Thermal Performance

22 - Section J Compliance

24 - Design Flexibility

26 - Achieving Comfort





It's what's inside that counts

Innovative ThermalHEART™ Technology.



ThermalHEART™ is the technology that lies at the core of AWS's range of thermally efficient aluminium window systems.

Thermal Break Technology

ThermalHEART™ products include a polyamide insulator, or thermal break, between the aluminium exterior and interior. This break minimises the transfer of heat and cold through the aluminium frame, giving the window excellent insulation properties.

Architects' Convenience

When it comes to large areas of glazing, the extra insulation provided by ThermalHEART™ technology gives you additional flexibility with regard to Building Code compliance.

A Versatile Range

The comprehensive ThermalHEART™ range includes commercial CentreGLAZE™ and FrontGLAZE™ framing in 100mm and 150mm platforms, along with a compatible door system for hinged, pivot or sliding installations. We can also fit awning sashes into most of these systems. Awning sashes will also accept IGUs up to 24mm. Our residential range includes sliding, hinged and bi-fold door systems along with awning and casement windows.

Efficiency and Comfort

When combined with double glazing, ThermalHEART™ glazing systems meet contemporary aspirations for energy conservation and comfortable interior temperatures.

Dual Colour Option

The unique ThermalHEART™ joining method allows for one finish on the outside and one on the inside, to complement both internal and external palettes.

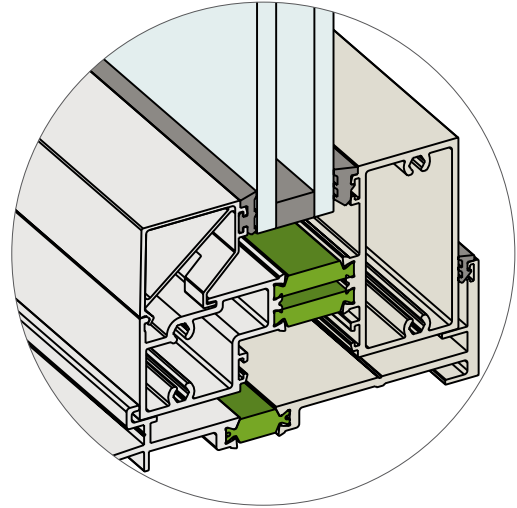

Innovative commercial systems.

Elevate™ with ThermalHEART™ technology is a range of state-of-the-art, thermally broken commercial systems that deliver drastically improved thermal performance. These market-leading systems have been designed and tested to deliver exceptional performance for the Australian commercial building sector, and to help architects and designers meet increasingly stringent energy requirements.

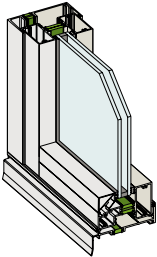

SERIES 804 THERMALLY BROKEN CENTREGLAZE™ FRAMING (100MM)

Series 804 CentreGLAZE™ shopfront frames with ThermalHEART™ technology measure 100mm x 60mm and are specifically designed to accept 24mm Insulating Glass Units (IGUs). Series 804 has a wide range of thermally broken sub-frames to cover most installations. This includes sub-sills with integrated nailing fin – ideal for residential installations.

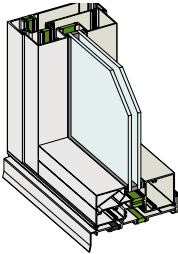

SERIES 806 THERMALLY BROKEN CENTREGLAZE™ FRAMING (150MM)

Series 806 CentreGLAZE™ shopfront frames with ThermalHEART™ technology measure 150mm x 60mm and are specifically designed to accept 24mm Insulating Glass Units (IGUs). Series 806 has a wide range of thermally broken sub-frames to cover most installations.

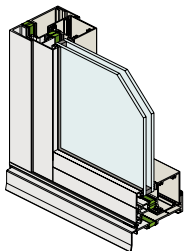

SERIES 824 THERMALLY BROKEN FRONTGLAZE™ FRAMING (100MM)

Series 824 FrontGLAZE™ shopfront frames with ThermalHEART™ technology measure 100mm x 60mm and are specifically designed to accept 24mm Insulating Glass Units (IGUs) with glass positioned close to the front of the frame. Series 824 can be supplied with external or internal glazing, and has a wide range of thermally broken sub-frames. This includes sub-sills with integrated nailing fin – ideal for residential installations.

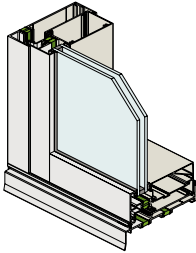

SERIES 826 THERMALLY BROKEN FRONTGLAZE™ FRAMING (150MM)

Series 826 FrontGLAZE™ shopfront frames with ThermalHEART™ technology measure 150mm x 60mm and are specifically designed to accept 24mm Insulating Glass Units (IGUs) with glass positioned close to the front of the frame. Series 826 can be supplied with external or internal glazing, and has a wide range of thermally broken sub-frames to cover most installations.

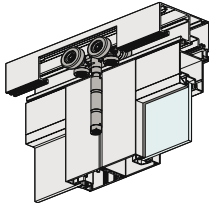

SERIES 831 THERMALLY BROKEN BI-FOLD DOOR (TOP HUNG)

The Series 831 thermally broken, top hung bi-fold door has been designed to integrate with thermally broken CentreGLAZE™ and FrontGLAZE™ framing. The 50mm thick door panels accept IGUs up to 28mm and can achieve very large panel sizes. AWS Centor™ twin stainless steel roller bearings running in heavy duty dual overhead tracks support the door panels. The E3 rollers will support panels up to 80kg delivering consistently smooth operation.

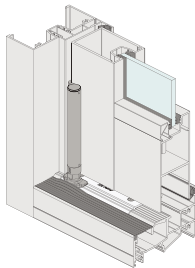

SERIES 832 THERMALLY BROKEN BI-FOLD DOOR (BOTTOM ROLLING)

The Series 832 thermally broken, bottom rolling bifold door has been designed to integrate with thermally broken CentreGLAZE™ and FrontGLAZE™ framing. The 50mm thick door panels accept IGUs up to 28mm and can achieve very large panel sizes. AWS Centor™ quad stainless steel roller bearings running in a heavy duty concealed sill track support heavy door panels up to 80kg. Rollers and pivots can be height adjusted as required.

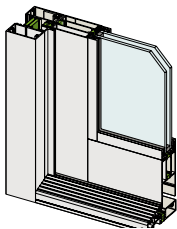

SERIES 852 THERMALLY BROKEN COMMERCIAL DOOR

Series 852 Thermally Broken Doors are compatible with the full range of ThermalHEART™ commercial systems. Available as hinged, pivot and sliding panels. Dedicated hardware and a variety of sills have been developed for this system to maintain efficiency and minimise air infiltration. Screen doors can be fitted to Series 852 doors when fitted into Series 806 or 826 (150mm) frames.

High performance residential systems.

Vantage framing with ThermalHEART™ technology was developed in response to growing environmental concerns and the need for energy efficient residential building designs. Vantage ThermalHEART™ systems offer significantly improved thermal performance and energy efficiency. This innovative range is 32% more thermally efficient than standard double glazed windows and doors. It is ideal for applications where minimising cold and heat transfer is a priority.

SERIES 726 **THERMALLY BROKEN AWNING/ CASEMENT WINDOW**

The Series 726 system uses a 100mm frame, mullion and transom with 2mm internal radius. Square external glazing beads are standard. The extra strong sash allows large sash windows to be fabricated for high wind load areas. The system has been tested for compliance with the relevant Australian standards, achieving very high water resistance of 600Pa and low air infiltration.

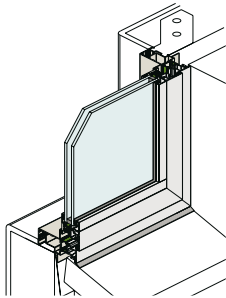

SERIES 729 **THERMALLY BROKEN HINGED DOOR**

The Series 729 system uses a 100mm frame, mullion and transom with 2mm internal radius. Square external glazing beads are standard. The doors have been tested for compliance with the relevant Australian standards. They achieved a high water resistance of 380Pa for external swing doors, and 150Pa water resistance for internal opening doors. This makes the product suitable for most residential applications.

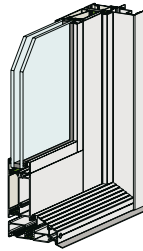

SERIES 730 **THERMALLY BROKEN BI-FOLD DOOR**

The Series 730 system utilises a 100mm frame. Square external glazing beads are standard. The extra-strong door stiles allow oversize door panels to be fabricated. This bi-fold door has been tested for compliance with the relevant Australian standards and achieved a high water resistance of 380Pa. The product is suitable for most residential applications.

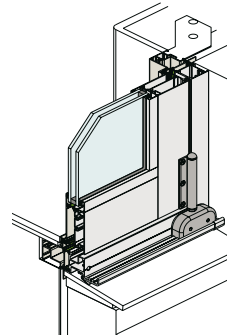

To access product specification sheets, specifier manuals, WERS data and CAD files, simply visit thermalheart.com.au

SERIES 731
THERMALLY BROKEN
SLIDING DOOR

Inspired by commercial stacking door systems, the Series 731 Thermally Broken Sliding Door incorporates commercial design features within a platform purposely designed for residential applications. The Series 731 is a bold and unique system with up to four sliding panels in each direction. It can be paired with the Centor™ roll-away S1 screening system.

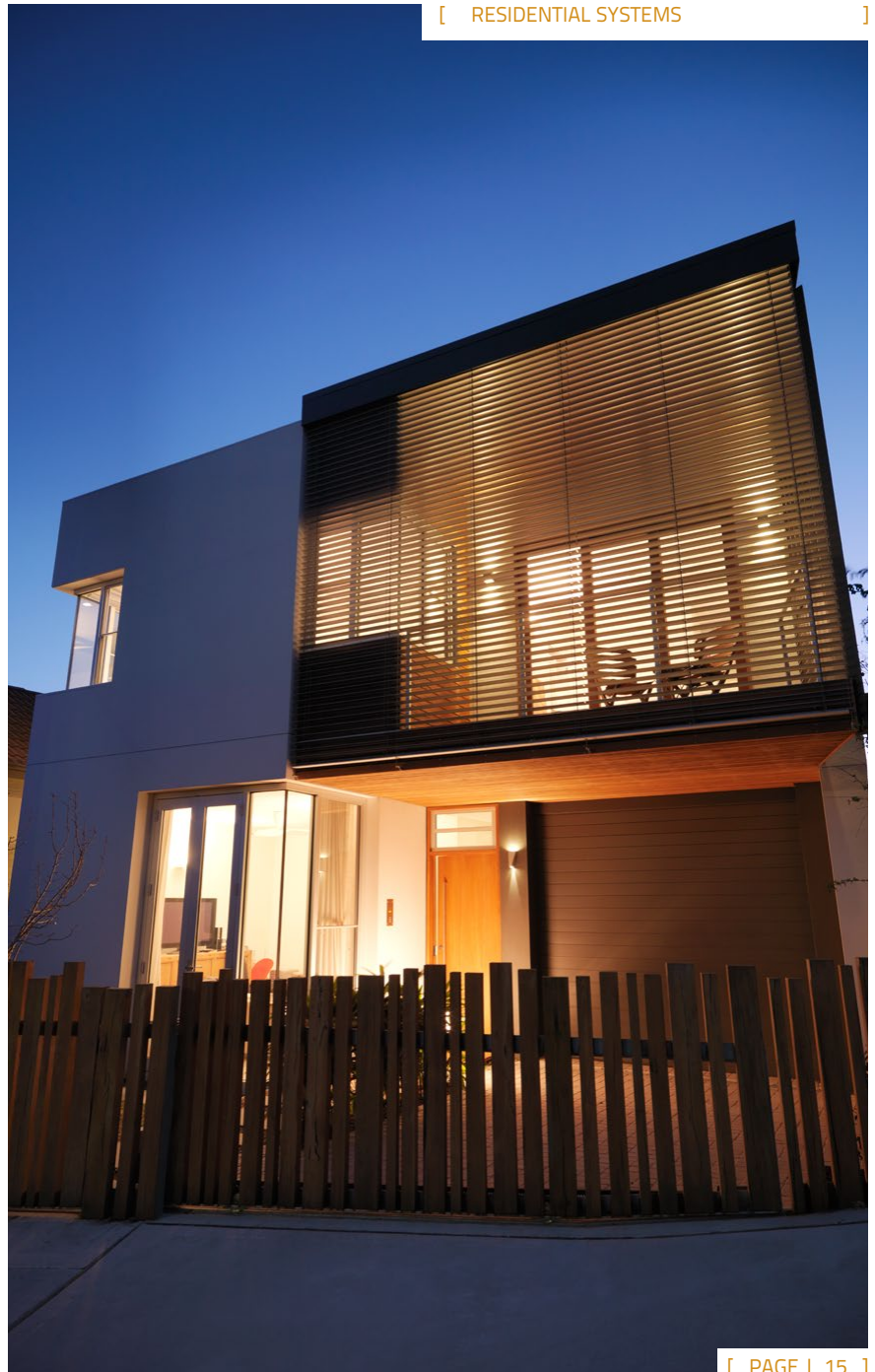
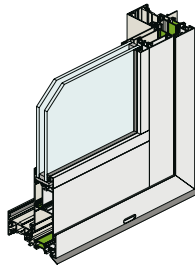

Give your projects the green light

ThermalHEART™ and the environment.



ThermalHEART™ window systems significantly reduce the requirements for artificial heating or cooling in buildings.

Commercial office and residential buildings account for approximately 23% of Australia's greenhouse gas emissions. ThermalHEART™ systems can substantially improve the thermal performance of a building envelope, and reduce the need for ongoing energy use to maintain interior comfort levels.

ThermalHEART™ AND THE ENVIRONMENT

ThermalHEART™ extrusions are composed of two aluminium profiles and one or more polyamide strips.

Aluminium can be recycled indefinitely. Recycled aluminium accounts for one-third of global consumption, and there is scope for recycled content of global production to be increased.

Aluminium windows are uniquely strong, lightweight, ductile and corrosion-resistant. Aluminium is also an excellent conductor of heat.

Bauxite, the ore of aluminium, is an abundant element of the earth's crust. The smelting and extrusion of aluminium requires large amounts of electricity, giving aluminium windows a high 'embodied energy'. Studies have indicated that aluminium windows typically last for more than 40 years.

By thermally breaking an aluminium window frame we can maintain the properties that make aluminium indispensable to the building industry. Adding insulation overcomes issues associated with high conductivity, such as unwanted heat gain and loss to the building envelope.

Used with double glazing, ThermalHEART™ systems can reduce requirements for artificial heating or cooling in buildings, lowering long-term energy requirements.

ThermalHEART™ systems are designed, tested and manufactured by Australia's largest and most geographically dispersed network of independent window makers. This reduces the environmental burden associated with importing and transporting similar systems from overseas.

We believe that aluminium windows and doors, particularly those which incorporate ThermalHEART™ technology, offer an excellent sustainability solution.

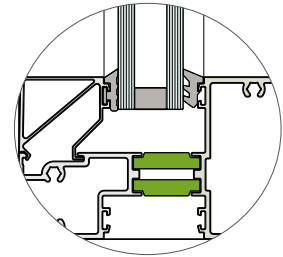

The thermal break in ThermalHEART™ extrusions is created using a polyamide strip.

Polyamide is an excellent thermal insulator. It has very similar expansion rates to aluminium, ensuring ThermalHEART™ extrusions maintain excellent structural integrity.

Window Energy Rating Scheme (WERS) data shows that ThermalHEART™ systems deliver U_w -Values as low as 1.9.

WERS is the Window Energy Rating Scheme for windows and doors in Australia. The rating of a window is based on its U_w -Value and Solar Heat Gain Coefficient (SHGC). ThermalHEART™ systems use advanced thermal modelling techniques during the design phase to ensure the best possible outcome and achieve very favourable WERS ratings.

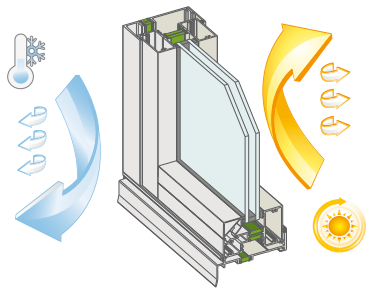

U_w-VALUE

The U_w -Value is the measure of how much heat energy is transferred through a window. The lower the U_w -Value, the better the window is at keeping the heat or cold out.

The illustration above demonstrates how the insulation properties of ThermalHEART™ systems, combined with appropriate glass selection, improve the U_w -Value and window performance in a cold climate. The principles would operate in reverse in a warm climate.

ThermalHEART™ systems provide excellent insulation, minimising the transfer of heat or cold between the internal and external environment.

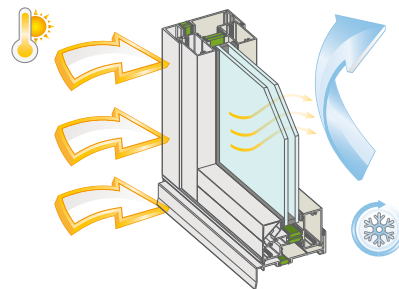

SOLAR HEAT GAIN COEFFICIENT

SHGC is a measure of how much solar radiation passes through a window. ThermalHEART™ systems drastically reduce solar heat gain through the window frame. Varying levels of solar radiation will still pass through the glass, offering passive solar heating. Appropriate glass selection will ensure the optimum performance of ThermalHEART™ windows based on climate zone.



WERS RATINGS

The tables shown to the right are extracts from the AWS product listings on the WERS certified products database. They illustrate the significant performance gains achieved by ThermalHEART™ systems.

The first table shows WERS data for a typical non-thermally broken CentreGLAZE™ commercial framing system with a common monolithic glass type – this glass and frame combination achieves a Uw-Value of 3.9.

The second table shows WERS data for a typical non-thermally broken CentreGLAZE™ double glazed commercial framing system with a variety of glass combinations – this system achieves a Uw-Value of 2.5.

The third table shows WERS data for a ThermalHEART™ CentreGLAZE™ system using the same glass alternatives as demonstrated in the previous table. This system achieves a Uw-Value of 1.9.

SERIES 400 CENTREGLAZE™ FRAMING – NON-THERMALLY BROKEN SGz

Window ID	Glass Type	Uw	SHGCw	Tvw
AWS-027-02	6SnClr	4.6	0.55	0.62
AWS-027-12	6.38CPClr	4.2	0.63	0.75

SERIES 424 CENTREGLAZE™ FRAMING – NON-THERMALLY BROKEN DG

Window ID	Glass Type	Uw	SHGCw	Tvw
AWS-028-10	6.38CPClr/12Ar/6	2.6	0.55	0.66
AWS-028-14	6.38CPGy/12Ar/6	2.6	0.38	0.31
AWS-028-26	6EVanGy/12Ar/6	2.7	0.30	0.26
AWS-028-18	6.38SnGy/12Ar/6	2.8	0.32	0.26
AWS-028-09	6.38CPClr/12/6	2.8	0.55	0.66
AWS-028-13	6.38CPGy/12/6	2.8	0.38	0.31

SERIES 804 THERMALHEART™ CENTREGLAZE™ FRAMING DG

Window ID	Glass Type	Uw	SHGCw	Tvw
AWS-054-06	6.38CPClr/12Ar/6	1.9	0.53	0.64
AWS-054-04	6.38CPGy/12Ar/6	1.9	0.36	0.30
AWS-054-17	6EVGy/12Ar/6	1.9	0.29	0.25
AWS-054-15	6.38SnGy/12Ar/6	2.0	0.30	0.25
AWS-054-05	6.38CPClr/12/6	2.1	0.53	0.64
AWS-054-03	6.38CPGy/12/6	2.1	0.37	0.30

Computer-simulated thermal modelling: performance insight to guide design.

Computer-simulated thermal modelling enables our design team to understand the thermal performance and energy efficiency of ThermalHEART™ window systems during the design phase. Thermal modelling simulations allow subtle adjustments and improvements to be made during the design phase, to maximise performance outcomes.



NON-THERMALLY BROKEN FRAME

The illustration right shows thermal modelling outcomes for a non-thermally broken CentreGLAZE™ frame with 24mm IGU. The purple colour indicates a temperature of approximately -15.7°C on the external element of the frame. This colour transitions through the frame with the internal element of the frame showing a temperature in the range of -9°C .

This model shows a significant transfer of heat between the internal and external frame elements. In this instance, the frame provides less insulation against a cold outside temperature than it would if a thermal break were incorporated.

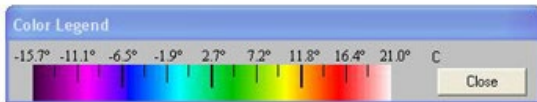
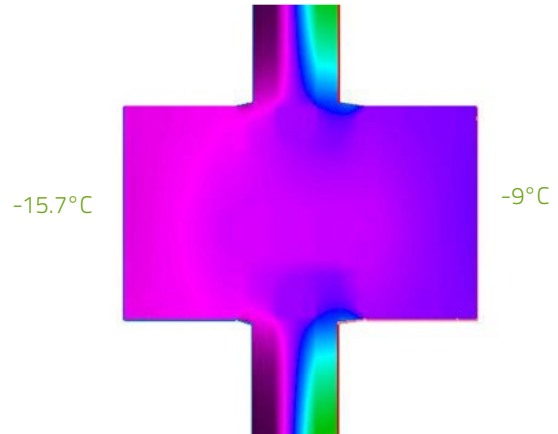

Thermal modelling uses colour to show the transmission of heat. The colour legend above shows the relative temperature associated with the colours portrayed on the thermal models.

	U-factor W/m2.K	delta T C	Length mm	Rotation
Frame	11.0794	39.0	61.9607	90.0
SHGC Exterior	11.6455	39.0	62.3421	90.0
Edge	2.4378	39.0	127	90.0

% Error Energy Norm: 5.97%

Export OK



THERMALHEART™ FRAME

The illustration right shows thermal modelling outcomes for a ThermalHEART™ CentreGLAZE™ frame with a 24mm IGU. The purple colour indicates a temperature of approximately -15.7°C on the external element of the frame.

You can clearly see the polyamide thermal break in the extrusion, highlighted blue. The thermal break maintains the separation achieved through the double glazing unit and insulates the internal elements of the frame from the cold external temperature. The internal element shown in green indicates a temperature of approximately 9°C .

This model shows a significant reduction in the transfer of heat between the internal and external frame elements. In this instance, the frame performs well as an insulator against a cold outside temperature and would assist in maintaining comfortable internal climate levels and reducing loads on artificial heating or cooling within the building envelope.

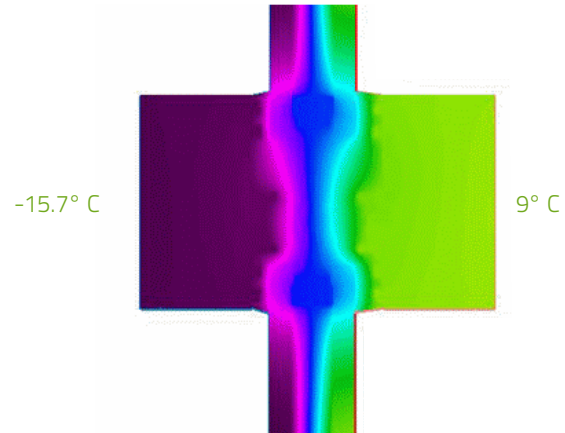

	U-factor W/m ² K	delta T C	Length mm	Rotation	
Frame	5.1898	39.0	61.9607	90.0	Projected in Glass Plane
SHGC Exterior	5.0734	39.0	62.3421	90.0	Projected in Glass Plane
Edge	2.3791	39.0	127	90.0	Projected in Glass Plane
% Error Energy Norm					8.41%
					Export OK

The rules have changed

And so have our systems.



Got a Section J migraine? Here's your pain relief.

Over the past five years, government requirements on energy efficiency in buildings have become ever more stringent. For a long time, window systems have been found lacking in this area. ThermalHEART™ changes this, delivering to the Australian market an immediate solution to Section J headaches.

THERMALHEART™ A SOLUTION TO SECTION J

The Building Code of Australia, Section J Part 2, sets out requirements for minimum energy efficiency provisions in multi-residential and commercial buildings. As government focus shifts to energy efficiency, these provisions are becoming more and more demanding.

Using the elemental Deemed-to-Satisfy method, the Section J Glazing Calculator sets out the minimum requirements for Uw-values and Solar Heat Gain Coefficients (SHGC), based on climate zone, building size, glass to façade ratio and orientation.

The inclusion of a thermal break ensures ThermalHEART™ systems typically meet or exceed the Uw-Values and SHGCs set out in Section J. In general, this means you can use large expanses of glazing – even in extreme climate zones – and still achieve a pass.

KINGHORN MOTORS CASE STUDY

When Kinghorn Motors VW decided to upgrade their Nowra showroom, a less-than-perfect aspect – facing the highway and eastern sun – meant Section J required extremely low Uw and SHGC values. These values were not achievable with standard single glazed commercial aluminium systems.

If not for ThermalHEART™ framing, compliance issues would have forced designers to alter the design and significantly reduce glazing throughout the building.

	Glazing element	Sector Faced	Size		Section J Requirement		Performance Standard Aluminium		Performance ThermalHEART™	
			H	W	u	SHGC	U	SHGC	U	SHGC
1	W7	N	4.50	5.50	3.9	0.47	3.87	0.62	3.1	0.23
2	W6	N	0.90	5.60	3.9	0.47	3.87	0.62	3.1	0.23
3	W9,W8	E	4.50	10.40	3.1	0.23	3.87	0.62	3.1	0.23
4	D1	E	2.40	1.80	3.1	0.23	3.87	0.62	3.1	0.23
5	W1	W	0.90	0.90	3.9	0.47	3.87	0.62	3.1	0.23
6	W2,W3,W4	W	1.80	2.70	3.9	0.47	3.87	0.62	3.1	0.23
7	W5	W	0.90	12.00	3.9	0.47	3.87	0.62	3.1	0.23
8	W10	S	4.50	5.50	3.9	0.47	3.87	0.62	3.1	0.23
9	D2	S	2.40	2.70	3.9	0.47	3.87	0.62	3.1	0.23
10	W11	S	0.90	3.80	3.9	0.47	3.87	0.62	3.1	0.23

This table illustrates the Uw-Value and SHGC figures achieved using standard aluminium framing versus ThermalHEART™ framing.

✗

✓

Don't let standards strangle your creativity, design the way you want with ThermalHEART™. Efficiency and comfort without compromise.

Architects and designers face continually tightening energy provisions when it comes to designing buildings. The challenge is to create beautiful, functional spaces while achieving compliance. ThermalHEART™ systems enable you to do just that.

BIG WINDOWS ARE BACK

Windows bring so much to our buildings: natural light, connection with the outdoors, ventilation and a sense of space. ThermalHEART™ systems ensure windows can continue to play an important role in energy efficient buildings.

Often a site will have a less-than-perfect orientation. Alternatively, clients may want large expanses of glazing facing a spectacular view or prominent street frontage. In many cases, a lack of thermally efficient window systems has forced architects and designers to alter designs, and reduce or eliminate windows, just to meet the energy provisions. ThermalHEART™ is the answer.

CLEAN BOLD LINES

ThermalHEART™ systems are designed to deliver a clean, bold aesthetic. To ensure a simple, unobtrusive style, frames are free of grooves or ridges, hardware has been carefully thought out and ingeniously fitted, and minimal radii have been applied to profiles.

DUAL FINISH TECHNOLOGY

To achieve excellent thermal performance, ThermalHEART™ systems incorporate an innovative polyamide insulator strip which separates the internal and external elements of the extrusion.

The way the thermal insulator is joined allows for a different choice of finish, to complement both internal and external finish palettes. The result? One finish on the outside, another on the inside, and unprecedented colour flexibility.

Architects and designers can now select the strong, bold, dark colours which feature prominently on commercial building exteriors, and opt for lighter, more neutral tones on the building's interior.

SINGLE FINISH

The same finish appears on the internal and external extrusion surfaces. Select any finish from the primary ThermalHEART™ finish card.

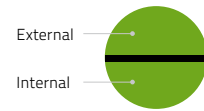

DUAL FINISH

A different finish appears on the internal and external extrusion surfaces.

External: select any finish from the primary ThermalHEART™ finish card.

Internal: select from the Internal Finish Palette .

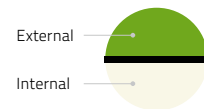

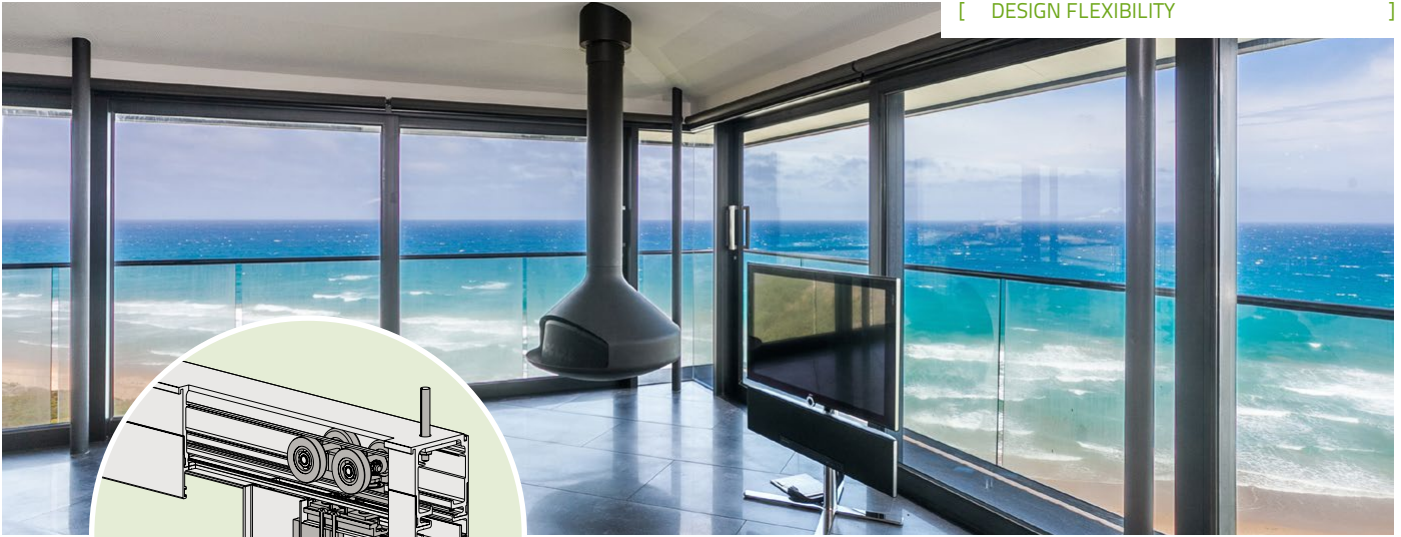

PRODUCT SPOTLIGHT.

Series 852 Thermally Broken Sliding Door

Top hung with Centor™ E3 Rollers –
the ultimate architectural solution

Looking for the ultimate thermally-broken, architectural solution? The Elevate™ ThermalHEART™ Series 852 Top hung sliding doors using Centor™ E3 rollers offers superb operation, excellent thermal performance, dual colour flexibility and contemporary architectural styling.

Offering panel sizes of up to 3m high and 2.6m wide this solution allows maximum opening widths whilst ensuring continued smooth operation.

As double glazing can become very heavy, the Series 852 top-hung sliding door incorporating E3 rollers and a custom head track will support door panels up to 250kg with finger tip operation.

Couple this solutions with a Centor™ retractable screen and flush thresholds for the ultimate architectural solution.

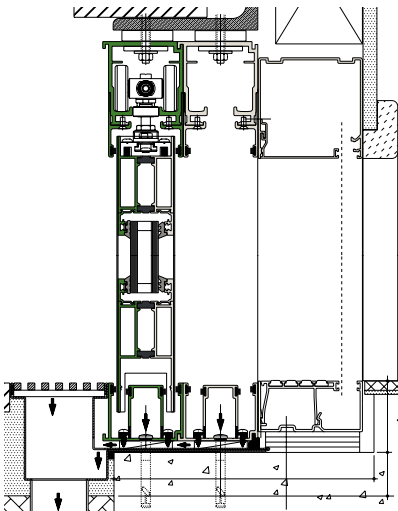

The architecture of happiness.

Create beautiful, comfortable spaces.



Don't lose sight of the ultimate aim: comfort.

Comfort is closely tied to the concept of happiness. Our sensory responses to elements like temperature and light let us know if we are comfortable, and this affects our happiness.

ThermalHEART™ systems help to maintain optimum internal temperatures in buildings, and reduce the need for artificial heating or cooling. Incorporating large expanses of glazing with minimal negative impact on efficiency ensures architects have the flexibility to maximise the use of natural light, and enhance the connection to the outdoors.

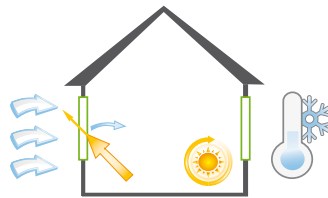

**THERMALHEART™
COLD CLIMATE**

COLD CLIMATE

To ensure comfort, buildings in cold climates typically need to be heated. ThermalHEART™ window systems can:

1. Drastically reduce the outside cold from entering the building, making buildings warmer.
2. Help keep the warm air in, reducing heating costs.
3. Reduce the risk of condensation, which often occurs due to the difference in temperature between the interior and exterior environments.

SICK BUILDING SYNDROME (SBS)

SBS is an emerging problem in an array of buildings. ThermalHEART™ systems inhibit condensation from forming on the inside of the window frame.

By reducing stagnant moisture you alleviate mould formation, and in turn, the respiratory illnesses that follow.

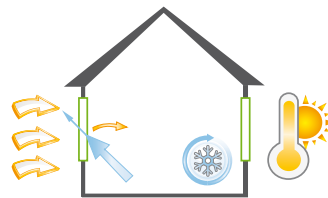

**THERMALHEART™
WARM CLIMATE**

WARM CLIMATE

In a warm climate, ThermalHEART™ systems:

1. Act as a buffer against the hot air outside, minimising the transfer of heat into a building.
2. Help to minimise the loss of cool air from artificial cooling units, reducing the need for cooling and lowering energy consumption.

PROJECT FEATURES

ThermalHEART™ in
the wild.

30 - Kinghorn Motors Case Study

32 - Flannery Centre Case Study

34 - Rumney Rest

38 - Dawes Residence







Kinghorn Motors Case Study

Project completed by Hanlon Windows.

With an ever-increasing focus on environmental sustainability, the pressure is on for builders and architects to meet very strict energy requirements. When Kinghorn Motors VW decided to upgrade their showroom on Princes Highway, Nowra, the project almost didn't make it past the planning stages. In fact, this beautiful and functional space may not have been built at all, had it not been for an innovative new product called ThermalHEART™.

The ThermalHEART™ thermally broken window and door system is a groundbreaking product which is opening up whole new vistas of possibility. The true genius of this energy-efficient revolution lies in its design. ThermalHEART™ consists of two pieces of aluminium joined with an insulating strip to minimise the transfer of heat and cold between the internal and external environment. Astonishingly, it is approximately 60% more efficient than a typical aluminum window, and it tipped the balance when it came to how the Kinghorn Motors Showroom performed thermally. Indeed, it was the key to meeting the stringent energy demands for new construction under Section J of the Building Code of Australia.

The major challenge to face the building design team was the showroom's less-than-perfect aspect, facing the highway and the eastern sun. Section J required the glazing to achieve extremely low U-values and minimal solar heat gain, which were unable to be met using conventional commercial aluminium products.

According to architect, Blair Mullins, from Art House Building Design, "When we were approached by a local car dealership to design their latest showroom we didn't imagine that we would undertake one of the first commercial uses of the Elevate™ ThermalHEART™ range of products. We were fortunate to have a close relationship with a local window company that specialises in energy efficient products. Without the use of thermally broken windows and doors from Hanlon Windows we would not have been able to achieve the outcome that we did. The combination of thermally broken aluminium frames and high performance IGUs with Low-E

glass made all the difference, and we were able to incorporate large glass façades to three sides of the building, which was extremely important for the car dealership owners as they wanted to obtain maximum exposure of their display area."

The front door of the showroom needed to be very large and, once again, the ThermalHEART™ range exceeded the client's expectations. The extra-strong door stiles on the Elevate™ Series 729 ThermalHEART™ Hinged Doors allowed for oversize door panels to be fabricated. The additional benefit of high water-resistance made the product the perfect choice.

The showroom façades were manufactured using Elevate™ Series 726 Fixed Awning Window Frames, and the extra-strong sash allowed large sash windows to be fabricated for high-wind areas.

Other products used included the Elevate™ Series 726 ThermalHEART™ Awning Windows, dual colour ClearMIST™ finish to all windows and doors, and AWS ICON™ Hardware. All glass installed was double glazed with a combination of Evergreen and Energy Advantage with a Low-E coating, to minimise solar heat gain and increase the insulation benefits.

The showroom's green building credentials were further bolstered with the use of recyclable and long-life materials. The width of the louvred sun-awning around the building's perimeter was calculated to provide winter sun while filtering out the summer sun – a basic solar passive principle which takes the load off heating and cooling systems. The lightweight external materials also have a small thermal mass while the internal thermal mass is elevated with the use of a concrete slab floor.

With all these elements combined, the result is a building that will continue to provide high energy efficiency for years to come – without sacrificing the architecturally-inspired design and clean, striking aesthetic.



Flannery Centre Case Study

Project completed by Bathurst Glass.

With the help of the Federal Government, Skillset, one of Australia's largest Group Training organisations, has created a world-class green skills and sustainability centre in the New South Wales Central Tablelands, in Bathurst.

The Flannery Centre, named after renowned environmental advocate and 2007 Australian of the Year, Tim Flannery, was built under the Green Star program run by the Green Building Council of Australia.

Crawford Architects were appointed with the significant task of designing a sustainable, practical and memorable architectural work. It is now the home of education in sustainability for the region, teaching and showcasing leading edge sustainable building solutions to the problems that building professionals face today and will face well into the future. Built with a reduced 'ecological footprint', the result is a building with a remarkably low energy demand for heating, cooling and lighting.

The brief for the building was simple. To create a green skills and sustainability centre for apprentices in regional Australia, with an all-encompassing design that promotes biodiversity, encourages recycling, adopts numerous water conservation techniques, has a reduced reliance on energy sourced from fossil fuels and limits soil-site displacement.

The paramount building requirement was to implement sustainable building techniques, with corresponding appropriate material and product selections that assist in the ongoing endeavour of ensuring the stock of natural resources is managed. Reverse veneer construction detailing, rammed earth walls and commercial thermally broken window frames are all contributing techniques and systems implemented in the building by Crawford Architects' Director Paul Godsell, to ensure The Flannery Centre maintains its exceptional sustainability and green rating.

Every part of The Flannery Centre's envelope fabric was required to have outstanding thermal performance – the glazing solution was no exception. The building required a large number of aluminium windows and doors, all in varying sizes and shapes. The glazing brief was a product that was to be thermally efficient, durable, aesthetically satisfying, and matched the modern appearance of the rest of the building – an interpretation of the rural shed – split with galleries and a student hub.

AWS's ThermalHEART™ range of thermally broken aluminium windows and doors was chosen for the job. The thermal break in ThermalHEART™ windows and doors is created using a polyamide strip between the aluminium exterior and interior elements. The thermal break minimises the transfer of heat and cold through the aluminium window frame, giving the thermally broken aluminium window excellent insulation properties. Polyamide has similar expansion rates to aluminium, ensuring ThermalHEART™ extrusions maintain excellent structural integrity.

Bathurst Glass Service, an experienced AWS fabricator was chosen to supply and install the aluminium windows and doors throughout the building due to its reputation for high quality products.

The completed project is a building with a reduced ecological footprint and a dramatically low energy demand.



Watch the Designer Notes here:
[youtube.com/specifyaws](https://www.youtube.com/specifyaws)

Rumney Rest

Project completed by Glass Supplies.

Situated 320 metres above sea level, this five hectare lot was to be shared in harmony with the wedge-tailed eagle's nesting territory, therefore minimal disturbance to the lot was a priority for both clients and designer.

Fundamentally designed on passive solar principles, the pavilion layout invigorates living whilst exploiting the vistas resulting in a remarkable, majestic rest point for clients.





Award winning building designer Mike Cleaver of Clever Design was responsible for this stunning residential project. Taking great pains to ensure all aspects of the clients' brief were met, Mike worked to create external living spaces that were well connected to the interior by large spans of glazing without compromising on the energy efficiency credentials of the dwelling.

The site utilises the natural land knoll in conjunction with the curvaceous roof form to deflect the prevailing south-westerly winds and provide a sheltered microclimate for the immediate external zoned living areas.

Due to the positioning of the home, Mike specified double glazing to ensure the thermal efficiency of the project. As the clients required large spans of glazing to open up their living spaces, Mike required a high performance framing solution to

ensure all openings were easily operable despite the weight of double glazing in large stacking doors.

Installed into the home were the AWS residential range of thermally broken large sliding doors as they operate effortlessly. The superior quality of these systems ensured that the doors glide on heavy duty rollers and in turn allowed for ease of operation.

Alongside builder Cave Constructions, Mike worked closely with window and door supplier Glass Supplies to ensure the window and door specification for the project achieved all the clients' needs. Glass Supplies recommended the efficient ThermalHEART™ range of aluminium systems throughout the home due to the extreme climate. Whilst the home was double glazed, the transfer of heat and cool also penetrates the frame itself.

The ThermalHEART™ range of aluminium frames is created using a polyamide strip between the aluminium exterior and interior elements, minimising the transfer of heat and cold through the aluminium frame.

Despite the large spans of glazing throughout the home, the use of double glazing coupled with the ThermalHEART™ aluminium frames allowed for the home to comply with energy requirements.

Designer Mike Cleaver also utilised several ThermalHEART™ Series 726 awning windows throughout the home. The strategic placement of these windows allows for cross ventilation opportunities throughout the home. This has ensured passive cooling in summer months and passive warmth in the winter months.

Glass Supplies coordinated the complex installation of large, heavy door and window panels on the steep site, achieving an impressive glazing solution for a very unique project.

The completed project is an amazing architecturally inspired home which utilises its landscape and surrounds to the fullest whilst maintaining thermal efficiency.



Watch the Designer Notes here:
[youtube.com/specifyaws](https://www.youtube.com/specifyaws)



Dawes Residence

Project completed by Viewco.

The Dawes Residence is an energy efficient home located in the most recent development in Kingston – Kingston Foreshores. Kingston is a suburb in the Australian Capital Territory where a large number of homes are being built along the foreshore of Lake Burley Griffin.

The clients were eager to make the most out of their superb location as well as create a home that had a state-of-the-art energy performance.

The clients also had a strong desire to have a home with a great indoor/outdoor flow, where internal rooms opened out onto balconies and decks.

Architect Tony Trobe of TT Architecture was appointed the difficult task of designing this house that required much design and material thought.

Tony used various techniques and materials in the design process to ensure the home was as energy efficient and practical as possible.

Tony designed the home with large spans of glazing to ensure the views of Lake Burley Griffin were maximised. To ensure the home suited the other architecturally inspired residential properties in the area, Tony designed the home with various shapes, including a large skillion roof as well as lots of triangular features throughout.







Due to the extent of the glazing required throughout, Tony Trobe relied heavily on aluminium window and door fabricator Viewco Glass, whom he had worked closely with in the past to advise on correct specification and installation detail.

Tony appreciated the extent of Viewco Glass's experience and expertise with aluminium windows and doors as they were able to provide practical input into the design process.

As the block is quite tight to the building envelope, the home was designed with high ceilings to create a sense of space. The large ceilings allowed Tony Trobe the opportunity to use large spans of glazing to ensure the view of Lake Burley Griffin was maximised.

With the advice from Viewco Glass, Tony decided on the ThermalHEART™ range of bi-fold doors for the feature at the back of the home. They decided to use the ThermalHEART™ systems as Tony did not want to compromise on the size of the bi-fold doors, but still required a high performance glazing system to ensure the large spans of glass didn't negatively impact the thermal efficiency of the home.

The ThermalHEART™ system allowed for the design the flexibility of large panel, thermally efficient and low maintenance windows and doors.

Other systems used on this project were a large ThermalHEART™ 731 sliding door which was located on the first level to look out



over Lake Burley Griffin. ThermalHEART™ Series 726 awning windows were used throughout the home to ensure ventilation as well as several Series 525 louvre windows which also helped with ventilation and created a thermal chimney within the home.

The overall project is a thermally efficient home that maximises the amazing views of its surroundings.



Watch the Designer Notes here:
[youtube.com/specifyaws](https://www.youtube.com/specifyaws)



GENERAL INFORMATION

All the extra bits
you'll want to know.

44 - General Information

46 - Colour Your World

48 - Choosing the Right Glass

50 - Hardware Solutions

51 - Hardware Catalogue

55 - Hardware Compatibility

56 - Typical Configurations

58 - Fabricator Network

60 - Showrooms





ThermalHEART™ Systems

General Information.



Australian-designed and manufactured, fully tested window and door systems.

By constantly evolving, AWS has maintained an unsurpassed reputation for design and performance excellence. ThermalHEART™ technology has been integrated into a selection of Vantage and Elevate™ Commercial systems to deliver a high-performance range of window and door systems for both commercial and residential applications. The ThermalHEART™ range represents dedication to precision, flexibility in design and unrivalled performance.

UNRIVALLED SERVICE

ThermalHEART™ window systems are proudly designed and extruded in Australia by Architectural Window Systems (AWS). In addition to developing some of Australia's most innovative aluminium joinery products, AWS technical services staff maintain an unrivalled level of support to fabricators in the window industry.

DESIGN AND INNOVATION

AWS designs all ThermalHEART™ window and door systems locally, for Australian conditions. AWS maintains a constant drive to refine, improve and modernise its aluminium profiles, and to enhance good looks, performance and manufacturability.

RESEARCH AND DEVELOPMENT

The AWS window and door testing laboratory is fully NATA accredited, and ensures that ThermalHEART™ systems comply with building codes and relevant industry standards. With one of the largest pressure booths in the industry, weather conditions can be simulated and remote monitoring of air leakage and deflection of windows and doors is also possible.



WORLD-LEADING TECHNOLOGY

We use world-leading technology to ensure that our ThermalHEART™ range of windows and doors has the strength to perform in the toughest environments.

A state-of-the-art thermal break machine from Belgium's Aluro company inserts the polyamide nylon strip, and rolls the three components – aluminium interior, exterior and thermal strip – tightly together into one rigid profile.

Colour your world!

More than
190 colour choices.

Choosing a colour for your window and door systems requires careful thought. All ThermalHEART™ window and door systems are made to order, so you have complete freedom to choose the perfect colour and finish for your project.



DUAL FINISH TECHNOLOGY

The thermal insulator joining method in ThermalHEART™ systems allows you to have one finish on the outside and another on the inside. This brings unprecedented flexibility to your colour selection.

Architects and designers can now select the strong, bold, dark colours which feature prominently on commercial building exteriors, and opt for lighter, more neutral tones inside.

SINGLE FINISH

The same finish appears on the internal and external extrusion surfaces. Select any finish from the primary ThermalHEART™ finish card.

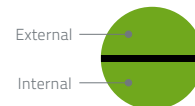

DUAL FINISH

A different finish appears on the internal and external extrusion surfaces.

External: select any finish from the primary ThermalHEART™ finish card.

Internal: select from the Internal Finish Palette .

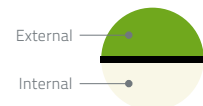

The standard ThermalHEART™ finish range is selected for popularity and suitability to architectural joinery. Custom finishes are also available upon request.

PRIMARY THERMALHEART™ FINISHES

If you want the same finish on the internal and external surfaces of your joinery, select any of the finishes below. Where a Dual Finish is preferred, select any of these finishes for the external joinery only.

Pearl White Gloss 1004	APO Grey Satin 1001	
Surfmist® Matt 2022 COLORBOND®	Citi® Pearl Matt 3002	
Rivergum Beige Gloss 2018	Ultra Silver Pearl Gloss 3005	
Magnolia Gloss 1012	Anotec Natural Pearl Matt 1009	
Primrose Gloss 1005	Precious Silver Pearl Kinetic Pearl Satin 3007	
Doeskin Satin 2006	Windspray® Matt 2024 COLORBOND®	
Paperbark® Matt 2016 COLORBOND®	Notre Dame Gloss 2014	
Pottery Satin 2016	Berry Grey Satin 2001	
Dune® Matt 2007 COLORBOND®	Dark Grey Matt 2005	
Sandbank® Matt 2019 COLORBOND®	Monument® Matt 2025 COLORBOND®	
Stone Beige Matt 1006	Woodland Grey® Matt 1008 COLORBOND®	

INTERNAL THERMALHEART™ FINISHES

If you would prefer a Dual Finish, select any of these finishes for the internal joinery.

Pearl White Gloss 1004	
Surfmist® Matt 2015 COLORBOND®	
Rivergum Beige Gloss 2018	
Paperbark® Matt 2016 COLORBOND®	
Dune® Matt 2007 COLORBOND®	
Anotec Natural Pearl Matt 1009	
Clear Anodised Matt 20µm 9101	

[**IMPORTANT NOTE**] Finishes shown on this page are a guide only and are not accurate representations of the actual powder coat or anodised finish. Please refer to the ThermalHEART™ finish card, or request powder coat swatches from your fabricator for colour matching. We also service some special or custom powdercoat requests, contact your local AWS representative or fabricator to see how far we can go.



Glass & Frame: a critical marriage











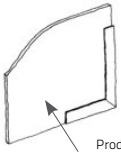



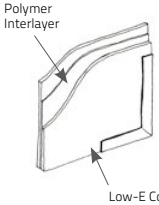





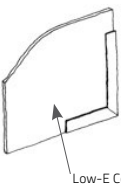

Understanding performance glass.

Performance glass can help to overcome site limitations, so views and natural light can still be enjoyed without compromising energy efficiency. You can also combine energy-efficient glass with other options, including glass that reduces noise, provides protection from intruders, and creates shelter from extreme weather.

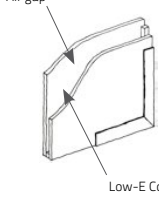
The performance of ThermalHEART™ combined with the right glass selection is a vital part of the building envelope and ideally should be considered early in the design process. Getting the glass selection right in the design stage can help make a project run more smoothly and allow you to take advantage of the most effective solution.

There are three main areas to consider when thinking about glass selection: natural light, solar heat gain, and thermal conductivity.

Compare the performance of some popular glass configurations.

	GLASS TYPE	ATTRIBUTES	GLARE REDUCTION	SOLAR HEAT REDUCTION	INSULATION	
	Ordinary Glass	4mm – 6mm				
	Viridian VFloat™ – Toned	4mm – 6mm Toned offers up to 32% greater solar heat reduction than ordinary glass		 ←	First step in solar heat reduction for sunny climates	
	Viridian VFloat™ – Supertoned	Supertoned offers up to 59% greater solar heat reduction than ordinary glass		 ←	High solar heat reduction for hot climates or demanding orientations, with no improvement in insulation	
	Viridian ComfortPlus™ – Clear	6.38mm Grade A safety glass. Up to 39% better insulation than ordinary glass		 ←		Good insulation with lower solar heat reduction for passive solar heating in cooler climates on northern orientations
	Viridian ComfortPlus™ – Green / Grey / Neutral	Green & Grey offers up to 41%, Neutral up to 40% greater solar heat reduction than ordinary glass		 ←		High solar heat reduction with good insulation and glare reduction for greater comfort in hot climates or demanding orientations
	Viridian EVantage™ – BlueGreen	Glass thickness 6mm EVantage offers up to 48% greater solar heat reduction than ordinary glass.				
	Viridian EVantage™ – SuperGreen	This is a reflective Low-E product which can be used in an IGU.		 ←		High solar heat reduction for outstanding comfort in hot climates or demanding orientations
	Viridian ThermoTech E™ – Clear	Unit thickness 12mm – 58mm				
	Viridian ThermoTech E™ – Toned & Supertoned	Up to 68% better insulation than ordinary glass		 ←		High solar heat reduction and superior insulation for outstanding comfort in hot climates or demanding orientations

* The performance indicated in the table is that of the highest performing product in that category for that characteristic, performance will differ by product. For detailed glass performance data visit www.viridianglass.com. ™ is a trade mark of CSR Building Products Limited. Reproduced with permission of Viridian. Not all products are appropriate for all applications, and some may require special assessment or processing in certain environments.

Intelligent Hardware Solutions

Intelligent selection and integration of hardware into our systems is a feature which sets our ThermalHEART™ commercial joinery apart. Hardware must be robust, conform to industry standards and maintain the integrity of the thermal break when installed.

INDUSTRY STANDARD HARDWARE

ThermalHEART™ systems accept industry standard hardware items. A unique mounting bracket has been developed to ensure industry standard hardware can be properly mounted to ThermalHEART™ commercial systems without compromising the thermal break and ensuring the integrity and strength of the frame and hardware mechanism.

STRONG MOUNTING POINTS

Consideration has been given to hardware mounting points throughout the design of commercial ThermalHEART™ systems. Items such as hinges, COC closers and lock mechanisms fix into rigid mounting platforms to ensure a strong and durable installation.

SPIGOTTED JOINERY

To ensure that commercial ThermalHEART™ systems will withstand the demanding requirements of commercial applications, frames are joined with thermally broken spigots to ensure strength and integrity of the system.

LEVER COMPRESSION LOCKING

Lever compression locking is an innovative mechanism which ensures optimum seal compression is generated around the perimeter of a door. The system is ideal for use on ThermalHEART™ systems and works to minimise air infiltration. The mechanism works by lifting the handle to extend the shootbolts and deadbolt. When deadlocked, the lever compression lock provides four points of locking for increased security.

- Features four points of locking including the latch, deadbolt and shootbolts.
- Upward motion of the handle activates the deadbolt and shootbolts.
- Downward action of the handle deactivates the deadbolts and shootbolts.
- When used with the correct strike, the lock generates optimum seal compression to provide improved water and air seal performance which maximises energy efficiency, especially for large panel doors.
- The handing of the lockset is adjusted by reversing the orientation of the latch bolt.
- The lockset can be keyed alike to a variety of industry standard products.



Developed to complement the modern design and clean lines of the Architectural Series, the ANDO™ range brings a fresh and sleek look to residential windows and doors.

Available across the range of window and door applications and in a wide variety of finishes, ANDO™ hardware offers a family appearance providing consistency throughout your project.

The ANDO™ range includes:

- ANDO™ Twin point sliding door lock
- ANDO™ Slimline sliding door lock
- ANDO™ Sliding window mortice lock
- ANDO™ Sliding door 'D' handle
- ANDO™ Hinged door lock
- ANDO™ Bi-fold activator
- ANDO™ Chainwinder





ICON™

The ICON™ hardware range is a fully integrated range of 316-grade stainless steel hardware for aluminium windows and doors.

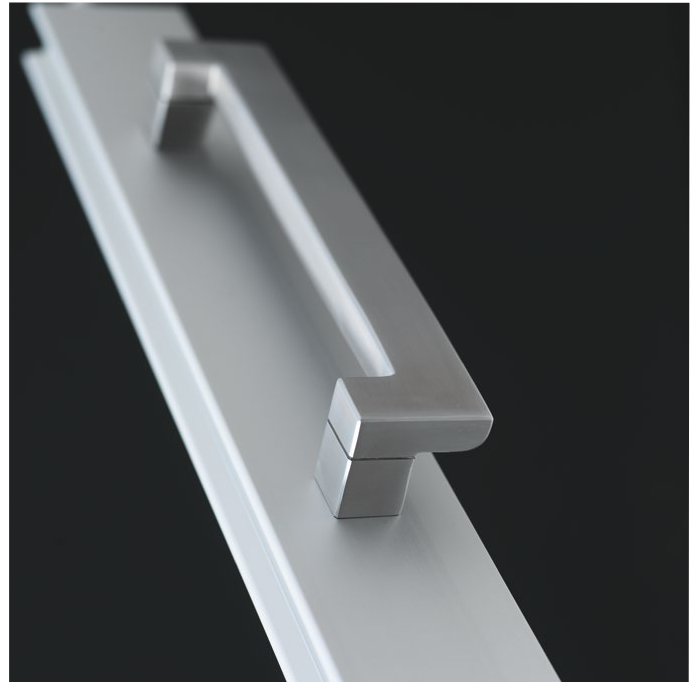

The range offers superior weathering performance and outstanding durability making it suitable for all environments.

Developed for use with our high performance window systems, ICON™ incorporates a square-edge, rectilinear look which complements the lines of Designer Series windows and doors.

The ICON™ range includes:

- ICON™ Flush pull
- ICON™ Sliding door 'D' handle
- ICON™ Sliding door lock
- ICON™ Hinged door lock
- ICON™ Bi-fold operator
- ICON™ Casement latch





MIRO™

The MIRO™ range of window and door hardware is a blend of contemporary design and function. It offers a unified look from window to door.

The smooth, ergonomic MIRO™ shapes offer good aesthetics as well as a comfortable hand grip. Secure and convenient locking features have been included.

MIRO™ hardware is manufactured from die-cast zinc and available in a range of contemporary powder coat finishes to match or contrast your aluminium joinery.

The MIRO™ range includes:

- MIRO™ Sliding door 'D' handle
- MIRO™ Hinged door lock
- MIRO™ Bi-fold operator
- MIRO™ Casement latch
- MIRO™ Cam handle

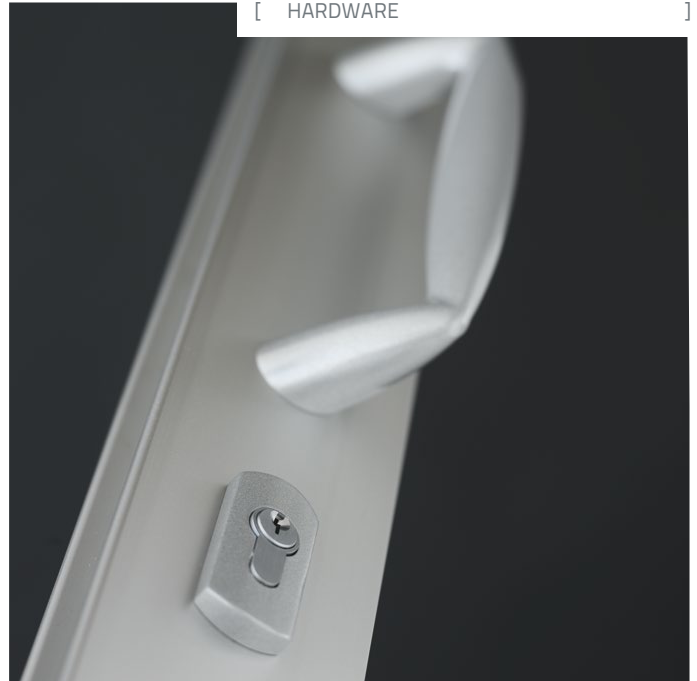



One Key Solution

Residential project security can be complex; reducing the number of key combinations for a project can simplify this and improve operability for end users.

The Vantage range of window and door hardware is designed to ease the complexity of home security. A range of keying options are available.

Depending upon the products and hardware specified, it is possible to achieve a single key solution for your project.

In almost all instances, Vantage window locks can be keyed alike, as can Vantage door locks, offering one key to operate all Vantage windows within your project and one key to operate all Vantage doors. This simplified approach brings security and peace of mind to end users.

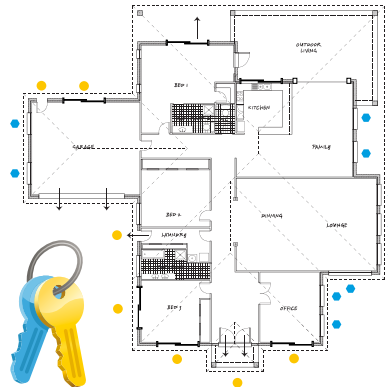

Key all windows alike and all doors alike to simplify security and operation

Hardware Compatibility

ICON™, ANDO™ and MIRO™ hardware is compatible with most ThermalHEART™ systems. To simplify your selection process, the table to the right indicates the compatibility of hardware with each ThermalHEART™ system.

	726	729	730	731	831	832	852
	Awning	Hinged	Bi-fold	Sliding	Bi-Fold	Bi-Fold	Door
ANDO™							
Single Point Sliding Door Lock							■
Twin Point Sliding Door Lock							■
Slimline Sliding Door Lock							■
Sliding Door Handle (with mortice lock)				■			■
Bi-fold Operator			■		■	■	■
Locking Lever Handle (2-point)		■	■		■	■	■
Locking Lever Handle (4-point)		■	■		■	■	■
Chainwinder	■						
MIRO™							
Single Point Sliding Door Lock							■
Sliding Door D-pull (with mortice lock)				■			■
Bi-fold Operator			■		■	■	
Lever Handle (2-point)		■	■		■	■	■
Lever Handle (4-point)		■	■		■	■	■
Lever Handle (with lever compression lock)		■	■		■	■	■
Wedgeless Window Fastener/Cam Handle	■						
ICON™							
Twin Point Sliding Door Lock							■
D-pull with ISEO Lock				■			■
Flush Pull (with mortice lock)				■			■
Bi-fold Actuator			■		■	■	
2-Point Hinged Door Lock		■	■		■	■	■
Multi-point (4) Hinged Door Lock		■	■		■	■	■
Lever Compression Hinged Door Lock		■	■		■	■	■
Wedgeless Window Fastener/Cam Handle	■						

Typical Configurations

Below are some typical configurations for Vantage windows and doors. These pages should be used as a guide only, there are many more options available. Talk to your local Vantage Fabricator to create the ideal configuration for your project.

Sliding Doors

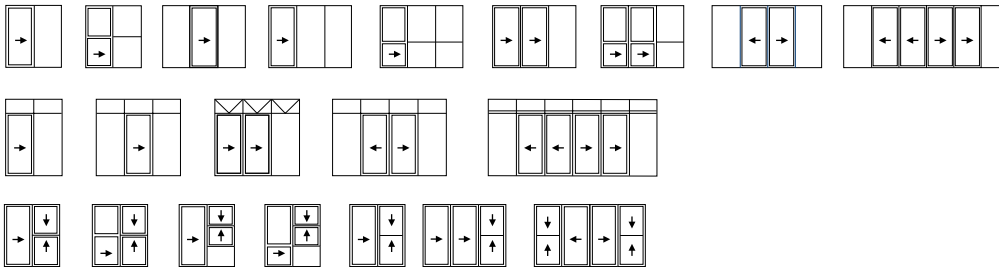

Hinged, French & Entrance Doors

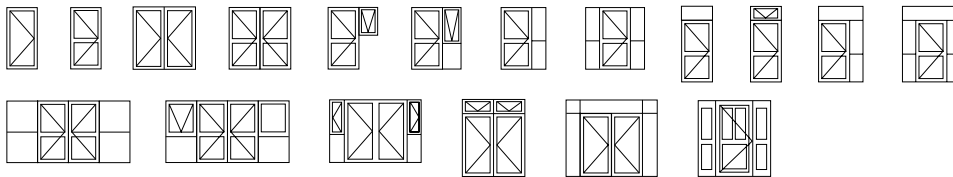

Bi-Fold Doors

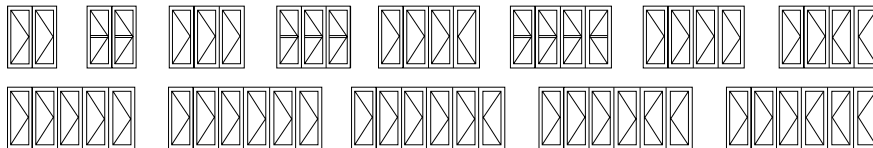



Awning Windows

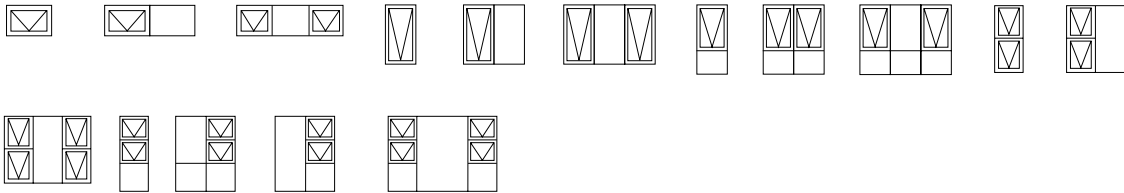

Casement Windows

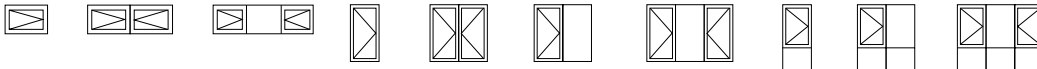

Key (all units viewed from the outside)



Fixed pane of glass with aluminium frame.



Opening window
(✓ points to lock slide)



Hinged door
(> points to lock slide)



Sliding door or window
(arrow indicates opening direction)

Our Fabricator Network

Across the country there are over 130 dedicated and highly trained licensed manufacturers of ThermalHEART™.





These privately owned and independent businesses compete within the residential and commercial construction markets.

AWS takes great pride in ensuring the efficiency of our network and maintains a close relationship with our licensed manufacturers. This commitment offers you a high level of confidence in selecting or specifying products from the Vantage or Elevate™ range of products.

The AWS network is capable of supplying high performance window and door systems for all types of construction projects from new and renovated residential dwellings to high-rise, commercial and industrial projects.

Our network is made up of highly trained professionals who can consult to you regarding all aspects of windows and doors, from energy ratings and glass selection to choice of surface finishes and hardware.

Find your local fabricator.

ThermalHEART™ fabricators are located throughout Australia in city and regional areas. To locate an AWS fabricator who can assist you with your project please visit our website thermalheart.com.au and click on the 'Fabricators' link.





Sensational Showrooms

AWS showrooms have long been regarded as some of Australia's best. Our network of highly skilled window and door fabricators are ready to assist you in selecting the ideal window and door systems for your project.

AWS showrooms are located across Australia – each one is different and unique, but they all share one thing in common – they offer you the opportunity to see and experience Vantage & Elevate™ systems in a relaxed environment with access to a team of qualified professionals who can help you make an informed decision about all aspects of your windows and doors.

Our showrooms feature products from our Residential, Designer, Thermally Broken and Commercial ranges. They also showcase a range of hardware, colour and glass options.

Making the right choice about windows and doors for your home is an important decision. Our fabricators' showrooms give you access to the products, tools and advice you need to make a decision which will enhance your lifestyle for years to come.

To locate your nearest showroom, click on the 'Fabricators' link on the ThermalHEART™ website: thermalheart.com.au



PHOTOS COURTESY OF YORK GLASS



FOR TECHNICAL SUPPORT & FABRICATOR LOCATIONS CALL 1300 026 189
or email marketing@awsaustralia.com.au

ABN 48 067 950 903
thermalheart.com.au

Head Office: 76-78 Jemma Road, Prestons NSW 2170
PO BOX 311, Liverpool NSW 1871, Australia